

# HT3548

## User's Manual RESISTANCE METER

# Contents

Introduction.....	4
Checking Package Contents.....	4
Safety Notes.....	5
Usage Notes.....	6
Chapter 1 Overview.....	9
<b>1.1 Overview and Features.....</b>	<b>9</b>
<b>1.2 Component Names and Operation Overview.....</b>	<b>9</b>
<b>1.3 Screen Layout.....</b>	<b>13</b>
<b>1.4 Checking the Measurement Target.....</b>	<b>17</b>
<b>1.5 Dimension.....</b>	<b>18</b>
Chapter 1 Preparing for Measurement.....	18
<b>2.1 Attaching the Strap.....</b>	<b>18</b>
<b>2.2 Loading or Replacing the Batteries.....</b>	<b>19</b>
<b>2.3 Connecting the Test Leads.....</b>	<b>20</b>
<b>2.4 Turning the Power On/Off.....</b>	<b>21</b>
<b>2.5 Pre-measurement Inspection.....</b>	<b>23</b>
Chapter 3 Basic Measurement.....	24
<b>3.1 Setting the Measurement Range.....</b>	<b>24</b>
<b>3.2 Connecting the Test Leads to the Measurement Target.....</b>	<b>27</b>
<b>3.3 Reading the Measured Value.....</b>	<b>27</b>
Chapter 4 Customizing Measurement Conditions.....	32
<b>4.1 Using Zero Adjustment.....</b>	<b>33</b>
<b>4.2 Stabilizing Measured Values (Averaging Function).....</b>	<b>37</b>
<b>4.3 Compensating for Thermal Effects (Temperature Correction (TC)).....</b>	<b>38</b>
<b>4.4 Compensating for Thermal EMF Offset (Offset Voltage Compensation Function: OVC Function).....</b>	<b>40</b>
<b>4.5 Setting the Delay Time for Measurement (Delay Function).....</b>	<b>41</b>
<b>4.6 Switching the Measurement Current (In the 300mΩ Range).....</b>	<b>43</b>
Chapter 5 Judgment and Conversion Functions.....	44
<b>5.1 Judging Measured Values (Comparator Function).....</b>	<b>44</b>
<b>5.2 Performing Temperature Rise Test (Temperature Conversion Function (<math>\Delta T</math>)).....</b>	<b>50</b>
<b>5.3 measuring conductor length (length conversion function).....</b>	<b>52</b>
Chapter 6 Panel Save and Load (Saving and Loading Measurement.....	53
<b>6.1 Save the measurement conditions (Panel save function).....</b>	<b>54</b>
<b>6.2 Reads the measurement conditions (panel reading function).....</b>	<b>54</b>
<b>6.3 Clearing the Contents of a Panel.....</b>	<b>55</b>
Chapter 7 Memory function.....	55
<b>7.1 Press any timing to save (manual storage).....</b>	<b>57</b>
<b>7.2 After stable measurement values automatically save.....</b>	<b>58</b>
<b>7.3 save at regular intervals (interval memory function).....</b>	<b>59</b>
<b>7.4 Display saved measurement data (stored display).....</b>	<b>60</b>

<b>7.5 Delete saved measurement data (clear memory)</b> .....	61
<b>7.6 The saved measurement data read into the computer</b> .....	62
Chapter 8 System Settings.....	64
<b>8.1 confirmation screen displays the date and time</b> .....	64
<b>8.2 calibration clock</b> .....	65
<b>8.3 initialized (reset)</b> .....	66
Chapter 9 Appendix.....	67
<b>Appx. 1 block diagram</b> .....	71
<b>Appx. 2 Four-Terminal (Voltage-Drop) Method</b> .....	71
<b>Appx. 3 on DC mode and AC mode</b> .....	71
<b>Appx. 4 on temperature compensation (TC)</b> .....	71
<b>Appx. 5 on temperature conversion function (<math>\Delta T</math>)</b> .....	71
<b>Appx. 6 Effect of Thermoelectromotive Force (Thermal EMF)</b> .....	71

## Introduction

---

Thank you for purchasing Hopetech CHT3548 Resistance Meter. To obtain maximum performance from the product, please read this manual first, and keep it handy for future reference.

### Registered trademarks

Windows and Excel are registered trademarks of Microsoft Corporation in the United States and/or other countries.

## Checking Package Contents

---

When you receive the instrument, inspect it carefully to ensure that no damage occurred during shipping. In particular, check the accessories, panel switches, and connectors. If damage is evident, or if it fails to operate according to the specifications, contact your authorized Hopetech distributor or reseller.

When transporting the instrument, use the same packaging materials used for the delivery to you.

### Check the package contents as follows

No.	Item	Quantity
1	3548 Resistance Meter	1
2	User's Manual	1
3	CD	1
4	USB Cable	1
5	9363A Test Clip	1
6	9705 Temperature Sensor	1
7	Strap	1
8	Alkaline battery	1
9	Carrying Bag	1



3548 Resistance Meter



Carrying Bag



9367 Alkaline battery



9366 Temperature Sensor



9363A Test Clip

## Safety Notes

---

The instrument is designed to conform to IEC 61010 Safety Standards, and has been thoroughly tested for safety prior to shipment. However, using the instrument in a way not described in this manual may negate the provided safety features.

Before using the instrument, be certain to carefully read the following safety notes.

### Note

Mishandling during use could result in injury or death, as well as damage to the instrument. Be certain that you understand the instructions and precautions in the manual before use.

### Notation

This manual contains information and warnings essential for safe operation of the instrument and for maintaining it in safe operating condition. Before using the instrument, be certain to carefully read the following safety notes.



Indicates very important message in this manual. When the symbol is printed on the instrument, refer to a corresponding topic in the Instruction Manual.



indicates DC (direct current)



indicates a fuse



indicates earth terminal

In this manual, the risk seriousness and the hazard levels are classified as follows.



Indicates an imminently hazardous situation that will result in death or serious injury to the operator.



Indicates a potentially hazardous situation that will result in death or serious injury to the operator.

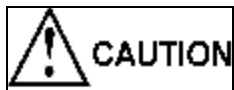

Indicates a potentially hazardous situation that may result in minor or moderate injury to the operator or damage to the instrument or malfunction.

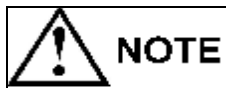

Indicates functions of the instrument or relative suggestion of a correct operation.

## Accuracy

We define measurement tolerances in terms of f.s. (full scale), rdg. (reading) and dgt. (digit) values, with the following meanings:

<b>f.s.</b>	(Maximum display value)
	This is usually the maximum display value. In the instrument, this indicates the currently used range.
<b>rdg.</b>	(Reading or displayed value)
	The value currently being measured and indicated on the measuring instrument.
<b>dgt.</b>	(Resolution)
	The smallest displayable unit on a digital measuring instrument, i.e., the input value that causes the digital display to show a "1".

## Usage Notes

---

### Installation environment

- I Operating temperature  
0°C to 40°C 80%RH or less (no condensation) and humidity ranges
- I Storage temperature

-10°C to 50°C 80%RH or less (no condensation) and humidity ranges

Installing the instrument in inappropriate locations may cause a malfunction of instrument or may give rise to an accident. Avoid the following locations.



- I Exposed to direct sunlight or high temperature
- I Exposed to corrosive or combustible gases
- I Exposed to water, oil, chemicals, or solvents
- I Exposed to high humidity or condensation
- I Exposed to a strong electromagnetic field or electrostatic charge
- I Exposed to high quantities of dust particles
- I Near induction heating systems (such as high-frequency induction heating systems and IH cooking equipment)
- I Susceptible to vibration

### Checking before use



Before using the instrument the first time, verify that it operates normally to ensure that no damage occurred during storage or shipping. If you find any damage, contact your authorized Hopetech distributor or reseller.

 <b>WARNING</b>	Before using the instrument, check that the coating of the test leads or cables are neither ripped nor torn and that no metal parts are exposed. Using the instrument under such conditions could result in electrocution. Contact your authorized Hopetech distributor or reseller in this case
--	--



### Handling Precautions

 <b>DANGER</b>	Do not modify, disassemble, or repair the instrument. This may result in fire, electric shock accident, or injury.
 <b>CAUTION</b>	Do not place the instrument on an unstable or slanted surface. It may drop or fall, causing injury or instrument failure.
 <b>NOTE</b>	To avoid corrosion and/or damage to the instrument due to battery leakage, remove the batteries from the instrument if it is to be kept in storage for an extended period. Be sure to turn the power off after using it.

## Measurement precautions

 <b>DANGER</b>	<p>To avoid electric shock accident and short circuit, please operate the instrument as following:</p> <p>Do not allow the instrument to get wet, and do not use it with wet hands. This may cause electric shock accident.</p> <p>Do not modify, disassemble, or repair the instrument. This may result in fire, electric shock accident, or injury.</p>
 <b>CAUTION</b>	<p>Do not place the instrument on an unstable or slanted surface. It may drop or fall, causing injury or instrument failure.</p> <p>To avoid any damage to the instrument, avoid any vibration or shock during transport or handling. Especially, be careful not to drop or fall the instrument which will cause shock.</p> <p>To avoid any damage to the instrument, do not input voltage or current to any measurement, TC terminals, or EXPORT terminals.</p>

## Handling leads and cables

 <b>DANGER</b>	<p>To avoid electrical shock accident, do not short test leads where voltage is applied.</p>
 <b>CAUTION</b>	<p>Do not use any test lead or temperature sensor other than the ones specified by our company. It may result in inaccurate measurement due to poor contact or other reasons.</p> <p>To avoid damaging the cables, do not bend or pull the base of cables and the leads.</p> <p>The ends of pin type leads are sharp. Be careful to avoid injury.</p> <p>Be careful not to allow contact between the lead wire and the heat generating portion.</p>



## Chapter 1 Overview

---

### 1.1 Overview and Features

---

The HT3548 employs the four-terminal method to highly accurately measure the DC resistance of measurement targets including motor and transformer windings, and welding, PC board patterns, fuses, resistors, and materials such as conductive rubber. The instrument allows temperature correction and so is especially suitable for measurement targets whose resistance values change with temperature.

#### Highly reliable specifications implemented in a compact, light-weight body

- I 35,000-dgt. high resolution
- I 0.1 $\mu\Omega$  resolution at 1 A measurement current

#### Simple temperature rise test (for temperature estimation during power stop)

- I Temperature conversion and interval measurement functions
- I Supports copying of measurement data file from the instrument memory to the PC.

#### Well-designed instrument shaped for measuring without taking your hands and eyes off the target, making it ideal for maintenance and large product measurement

- I Strap-attachable portable type
- I Standard auto-memory and auto-hold, and optional L2105 LED Comparator Attachment

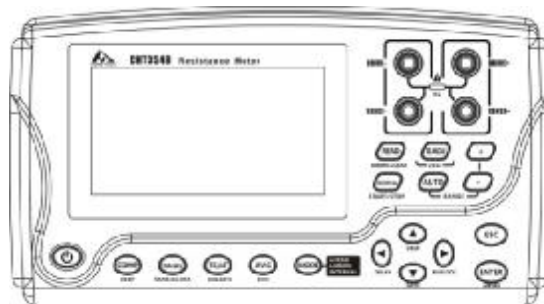

### 1.2 Component Names and Operation Overview

---

## Front Panel

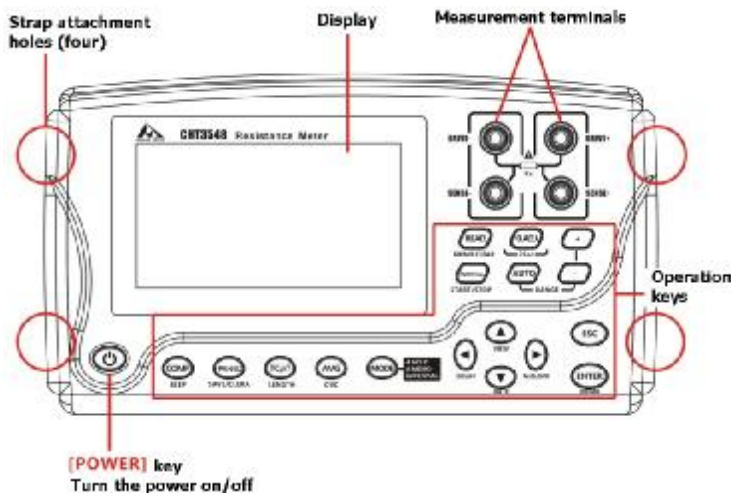



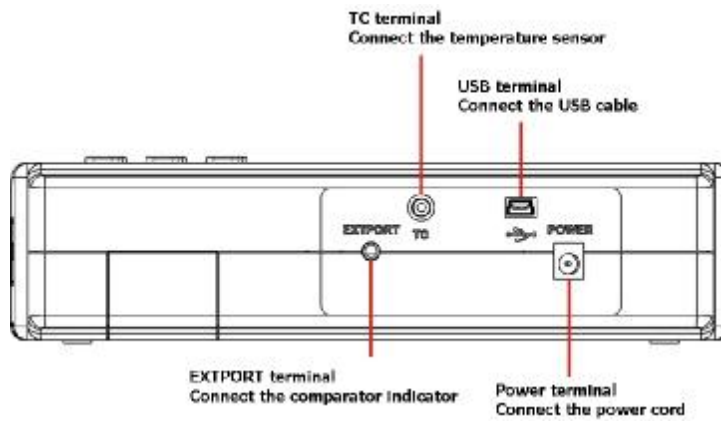



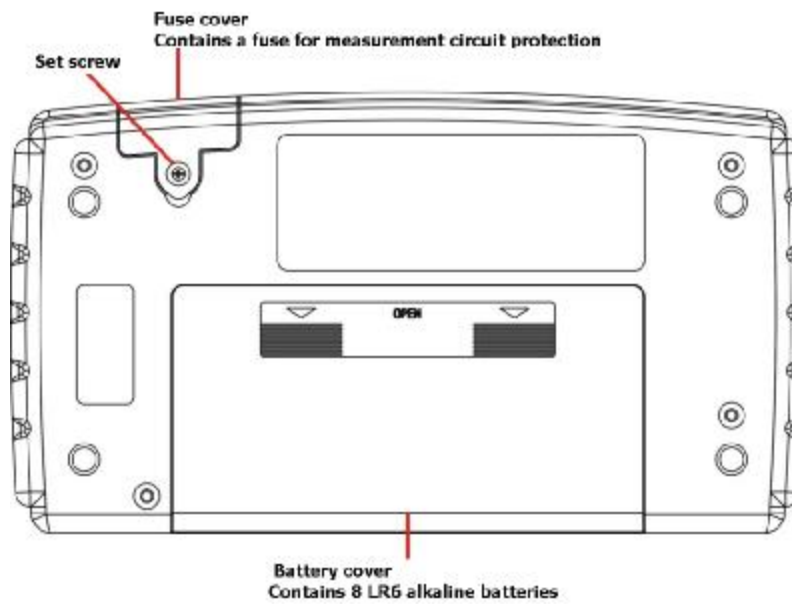







## Rear Panel



## Rear panel





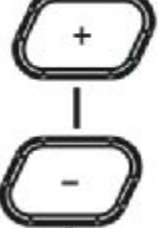

Key	Description
	<p><b>[COMP] key</b></p> <p>Comparator: oFF — ON (ABS mode) — ON (REF% mode).</p> <p><b>[BEEPSET] key (press and hold)</b></p> <p>Judgment sound: oFF — Hi — in — Lo — Hi-Lo — ALL1 — ALL2.</p>
	<p><b>[PANEL] key</b></p> <p>Panel load: Changes the panel No. "PrSEt" initializes the measurement conditions.</p> <p><b>[SAVE/CLEAR] key (press and hold)</b></p> <p>Saves and clears panels: SAVe — CLr</p>
	<p><b>[TC/ΔT] key</b></p> <p>Temperature correction/conversion function: oFF — TC — ΔT.</p> <p><b>[LENGTH] key (press and hold)</b></p> <p>Length conversion function: oFF — ON.</p>
	<p><b>[AVG] key</b></p> <p>Averaging function: oFF — 2 — 5 — 10 — 20.</p> <p><b>[OVC] key (press and hold)</b></p> <p>Offset voltage compensation (OVC) function: oFF — ON.</p>
	<p><b>[MODE] key</b></p> <p>Switches memory hold mode: oFF — A.HOLD (auto-hold) → A.HOLD,A.MEMORY (auto-memory) → INTERVAL (interval function).</p>
	<p><b>[←] key</b></p> <p>Moves to a different digit of the setting.</p> <p><b>[DELAY] key (press and hold)</b></p> <p>Delay function: PrSEt (factory default) — 10 ms — 30 ms — 50 ms — 100 ms — 300 ms — 500 ms — 1000 ms.</p>
	<p><b>[▶]key</b></p> <p>Moves to a different digit of the setting.</p> <p><b>[M.BLOCK SEL] key (press and hold) (p. 76)</b></p> <p>Selects a memory block: A — b — C — d — E — F — G — H — J — L.</p>
	<p><b>[▲] key</b></p> <p>Changes values and items.</p> <p><b>[VIEW] key (press and hold)</b></p> <p>Toggles the display: Temperature — no indicator — memory number. (MEMORY No.)</p>

	<p><b>[▼]key</b> Changes values and items.</p> <p><b>[DATE] key (press and hold)</b> Displays the date and time confirmation screen.</p>
	<p><b>[ESC] key</b> Cancels the setting (when in the setting screen). Releases a HOLD state (if in a HOLD state).</p>
	<p><b>[ENTER] key</b> Applies the setting.</p> <p><b>[MEMORY] key (press and hold)</b> Saves the measured values (manual memory).</p>
	<p><b>[READ] key</b> Displays saved measurement data.</p> <p><b>[MEMORY CLEAR] key (press and hold)</b> Clears memory: LAsT (Latest data from the selected block) — bLoC (Selected block) ^ ALL (All data).</p>
	<p><b>[ INTERVAL] key (press and hold)</b> Starts/stops interval measurement (when in interval mode).</p>
	<p><b>[ 0 ADJ] key (press and hold)</b> Zero adjustment.</p>
	<p><b>[RANGE] key</b> Measurement range: 3mΩ ↔ 30mΩ ↔ 300mΩ ↔ 3Ω ↔ 30Ω ↔ 300Ω ↔ 3kΩ ↔ 30kΩ ↔ 300kΩ ↔ 3MΩ.</p>

### Power-on settings

To perform one of the following settings, it is necessary to turn the power from off to on while holding-down a particular key.

For details, see the indicated page.

Clearing zero adjustment	
Switching to a different measurement current	
Disabling auto power save (APS)	
Clearing all measurement data saved	

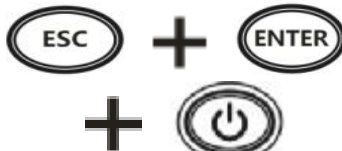
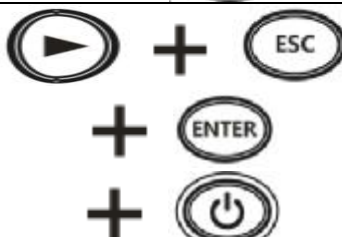
Resetting the current measurement conditions	
Resetting the system	

### 1.3 Screen Layout

#### Display (when the entire display is lit)

Displays measurement conditions, settings, measured values, memory numbers (MEMORY No.), panel numbers, comparator settings, judgment results, etc.

For information on the error display, see “Error display and actions”



#### Resistance measurement screen

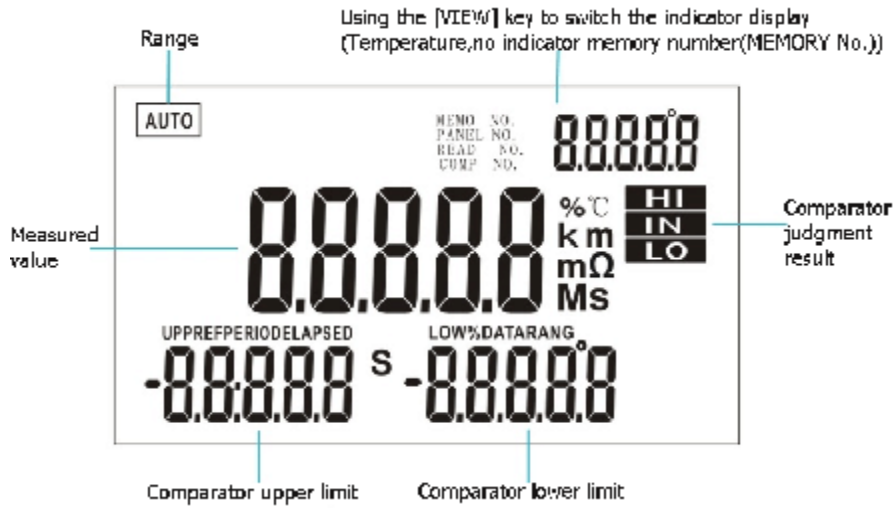

### Length conversion measurement screen

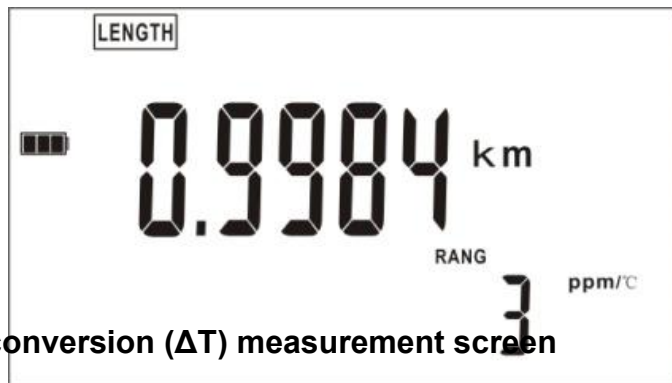

### Temperature conversion ( $\Delta T$ ) measurement screen

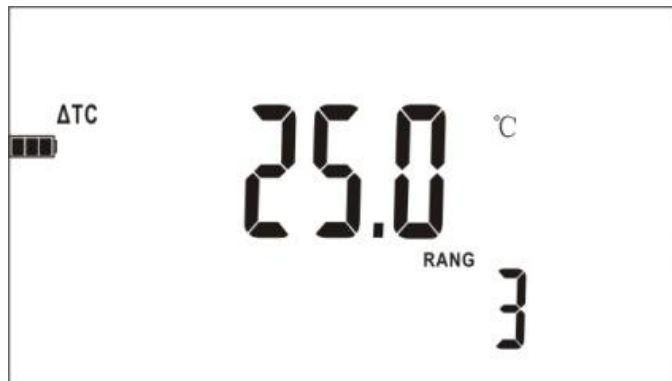

### Interval measurement screen



**Non-measured value display Out-of-range**



**Current fault**

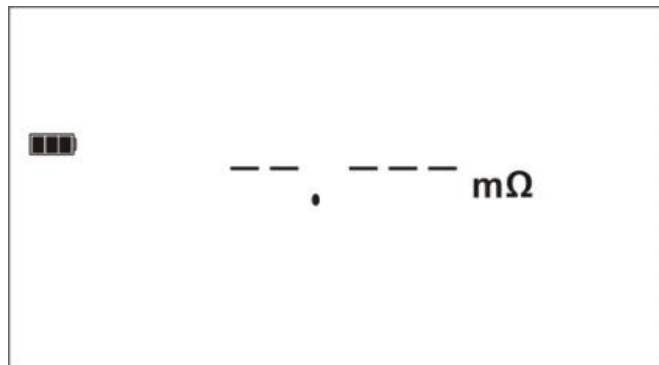

**The protection function is working**



### Fuse blown out









Indicator	Description
<b>0.ADJ</b>	Lit: The zero adjustment function is enabled. Blinking: Zero adjustment is in progress.
<b>A.HOLD</b>	The auto-hold function is enabled.
<b>A.MEMO</b>	The auto-memory function is enabled.
<b>(buzzer)</b>	The beeper function is enabled.
<b>APS</b>	The auto-power-save function is enabled.
<b>BATT</b>	The remaining battery state.
<b>AVG</b>	The measured value averaging function is enabled.
<b>DATE</b>	Lit: showing the current time.
<b>HOLD</b>	The measured value is being held.
<b>MEMO NO.</b>	The notation appears when using the data storage function, showing the memory number.
<b>READ NO.</b>	The notation appears when reading the saved data, showing the read number of the data.
<b>SET</b>	The notation appears when doing the settings for each function.
<b>COMP</b>	Comparator function is enabled.
<b>PASS</b>	The notation appears when the comparator judgement result is confirmed as qualified.
<b>FAIL</b>	The notation appears when the comparator judgement result is confirmed as failure.



<b>INTERVAL</b>	<p>Lit: The interval measurement function is enabled.</p> <p>Blinking: The processing of the key pressed cannot be performed because interval measurement is being performed or the interval measurement function is enabled.</p>
-----------------	---

## 1.4 Checking the Measurement Target

To carry out proper resistance measurement, change the measurement conditions appropriately according to the measurement target. Before starting measurement, use the examples recommended in the following table to configure the instrument.

Measurement target	Recommended settings (Bold indicates a change from the factory default.)		
	Temperature correction (p. 50)/ Temperature conversion (p. 67)	OVC (p. 51)	Measurement current at 300mΩ range (p. 55)
Motor, solenoid, choke coil, transformer, wiring harness 	<b>TC</b>	OFF	Lo
<b>For power</b> Contact, wiring harness, connector, relay contact, switch 	*1	<b>ON</b>	Lo
Conductive coating material, conductive rubber 	-	OFF	Lo
General resistance measurement Fuse, resistor, heater, wiring, welding 	*1	<b>ON</b>	Lo
Temperature rise test (Motor, choke coil, transformer) 	$\Delta T^{*2}$	OFF	Lo
Automobile ground wire <b>For signal</b> Contact, wiring harness, connector, relay contact, switch 	*1	<b>ON</b>	<b>Hi (300mA)</b>
	If the instrument is used to measure the resistance of a signal contact, the contact status will be changed, because its open-circuit voltage and measurement current are both high. To measure a signal contact, use the RM3545.		

I When the measurement target significantly depends on temperature, use the temperature correction function.

I The interval measurement function allows you to save a measured value every fixed interval.

## 1.5 Dimension

---

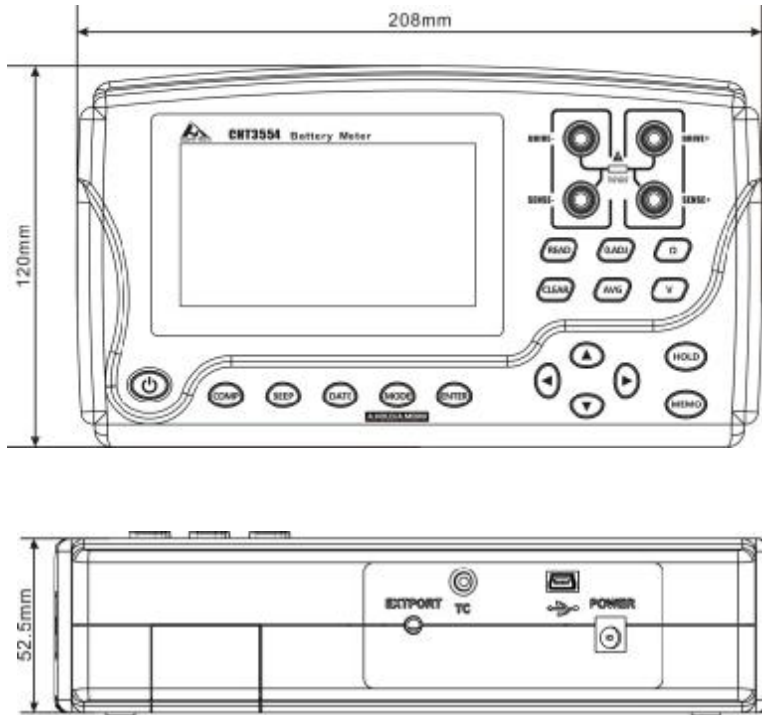

## Chapter 2 Preparing for Measurement

---

### 2.1 Attaching the Strap

---

Attaching the strap to the instrument allows you to use it with the strap around your neck. Follow the procedure below to attach the strap.

**Note:**

Use the four attachment points on the instrument to attach the strap securely. Otherwise, the instrument may drop during carrying, damaging the instrument and the operator may get hurt.

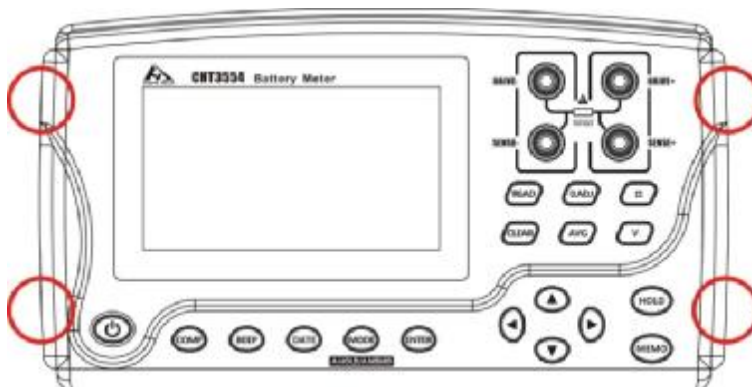

## 2.2 Loading or Replacing the Batteries

---

Before using the instrument for the first time, load the eight alkaline batteries (LR6). Before measurement, check that the instrument has sufficient remaining battery power. If the remaining battery level is low, replace the batteries. See the battery indicator to check the remaining battery level.



Do not short circuit, charge, disassemble, or incinerate batteries. Doing so may cause an explosion and is dangerous.

To avoid electric shock accident, remove any test leads before replacing batteries.

After the replacement, be sure to reattach the cover.

Poor performance or damage from battery leakage could result. Observe the cautions listed below.

Do not use both new and old batteries or different types of batteries together.

Be careful to observe battery polarity. Otherwise, poor performance or damage from battery leakage could result.

Do not use batteries after their recommended expiry date.

Dispose of batteries in accordance with local regulations.



When the remaining battery indicator is lit, the battery becomes low. Charge or replace the batteries as soon as possible.

### Replacing the battery steps:

1. Turn the power off. Remove any test leads.
2. Remove the battery cover on the back for the instrument
3. Load the LR6\*8 batteries. Be careful of their polarity.
4. Reattached the battery cover on the back of the instrument.

### LR6 battery replacement

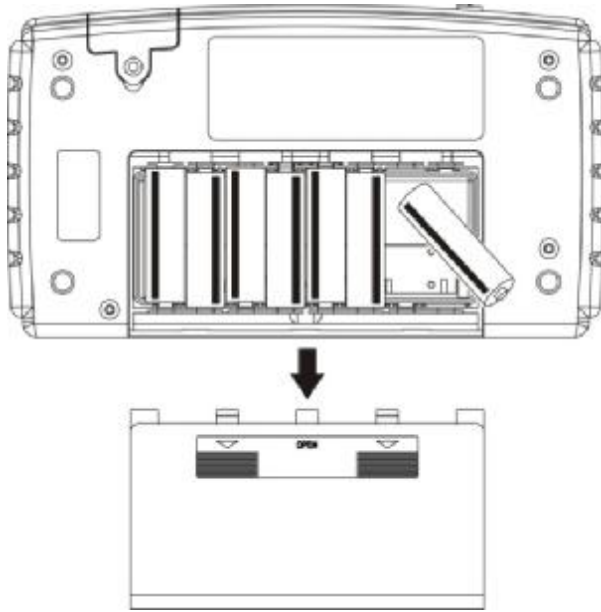

### Lithium battery replacement

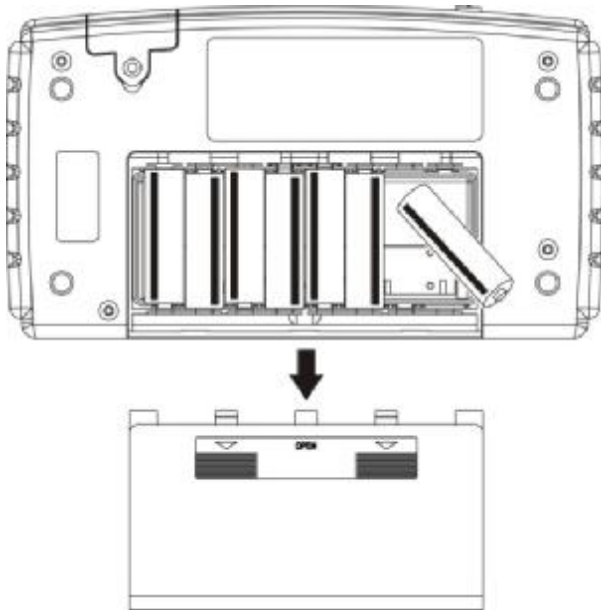

## 2.3 Connecting the Test Leads

---

### **WARNING**

I To avoid electric shock accident, connect the test leads correctly.

### **NOTE**

I To be safe, do not use any test lead other than the ones specified by our company.

- I The ends of leads are sharp. Be careful to avoid injury.

Connect the test leads to the instrument. Connect the four terminals: DRIVE (+, -) and SENSE (+, -).

## 2.4 Turning the Power On/Off

---

### Turning the power on

Press the **[POWER]** key to turn the power on. Hold the key down until the entire display turns on.



### Entire display lit



A self-test is started. The model name and version number are displayed during the self-test.

### Turning the power off

Press the **[POWER]** key to turn the power off. Hold the key down until the entire display turns off.

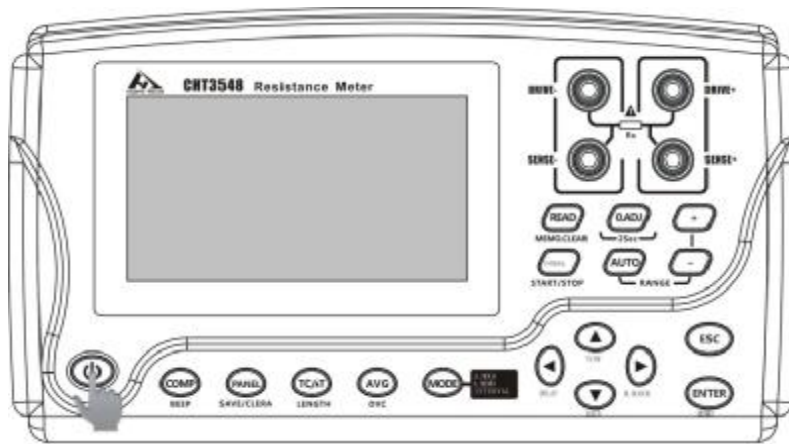

Entire display off

## IMPORTANT

When the instrument is turned on again, it starts up with the previous state used immediately before turning it off.

### Automatic power off with auto power save (APS)

When the instrument is not being used, the APS function automatically turns it off to reduce battery consumption.

### APS function ON

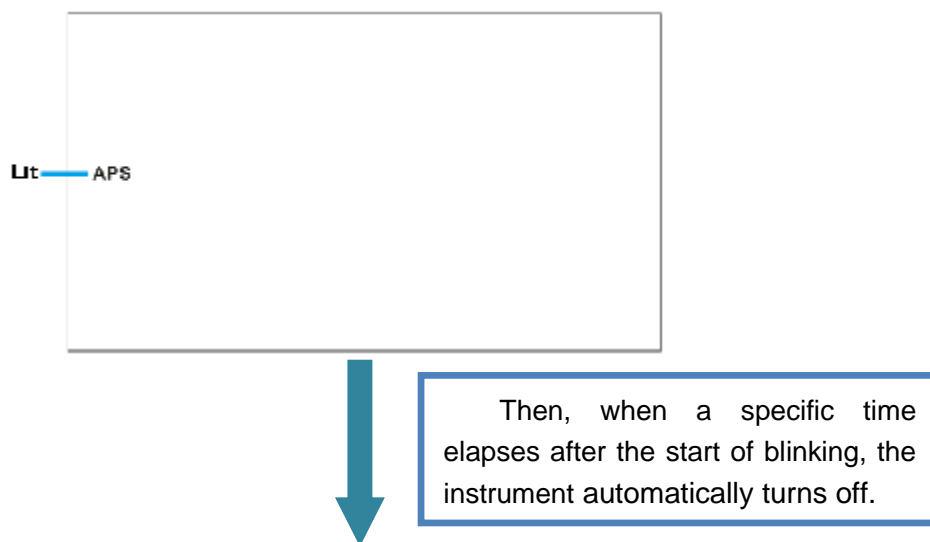

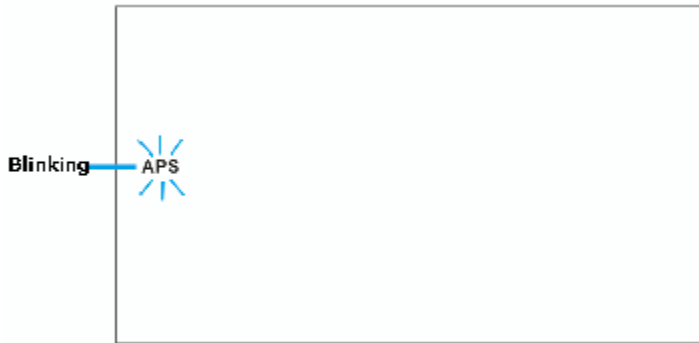

If no key is operated for 10 minutes or the instrument is in a measurement error state continuously, the APS indicator starts blinking.

### IMPORTANT

- I During an interval measurement, the APS function automatically turns OFF. When the interval measurement ends, the APS function automatically turns ON.
- I When the USB is connected, the APS function automatically turns OFF. When the USB is disconnected, the APS function automatically turns ON.

### Disabling auto power save (APS)

To disable the APS function, press the **[POWER]** key while holding the **[ENTER]** key down when the power is off.

The setting of the APS function is not saved. When the instrument is turned on again, the APS function is enabled again.

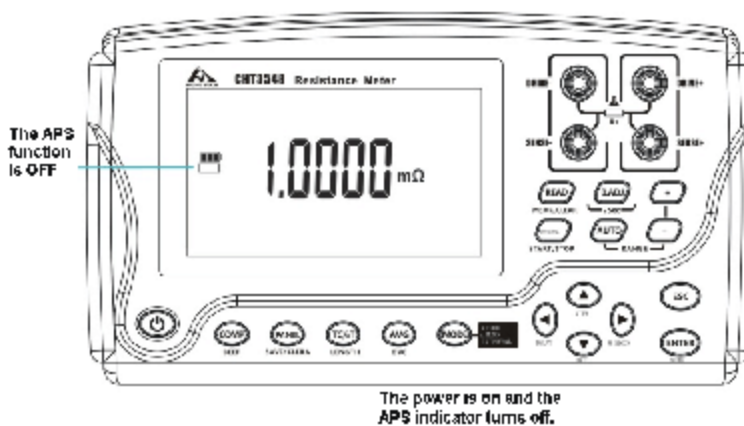



## 2.5 Pre-measurement Inspection

Before using the instrument, inspect it to verify that no damage has occurred during storage or transportation and it operates normally. If you find any damage, contact your authorized Hopetech's distributor or reseller.

## Instrument and peripheral checking

Inspection item	Action
Is there any damage or a crack in the instrument? Are the internal circuits exposed?	If any damage is found, do not use it. Return it for repair.
Is there any dust or contamination, such as pieces of metal, on any terminals?	If dust or contamination is adhered to a terminal, clean the terminal with a swab or the like.
Is the test lead coating broken or is the metal exposed ?	If the coating of a test lead is broken, the measured value may become unstable or have an error. Replace the damaged test lead.

## Power-on checking

Inspection item	Action
Is the remaining battery power sufficient?	The  indicator at the upper right of the display indicates the current status. If the indicator changes to  , the remaining battery level is low. Replace the batteries as early as possible. If the battery level becomes too low to continue with measurement, the  starts blinking. Replace the batteries.
Is anything missing from the screen?	Turn the power on to make sure that the entire display turns on. If there is anything missing, return the instrument for repair.
When you turn the power on, does the entire display turn on and then the model name and a measurement screen appear on the screen?	If the screen does not behave like this, the instrument may be damaged internally. Return it for repair.

## Chapter 3 Basic Measurement

---

Before measurement, be sure to read this chapter.

### 3.1 Setting the Measurement Range

---



Select a measurement range. Automatic range selection (the auto range) is also available.

### IMPORTANT

When the auto range is used or the measurement range is set to 30mΩ or less, a maximum current of 1 A may constantly flow through the measurement target, and a maximum power of approximately 2 W may be applied\*.

If there are any of the following concerns, depending on the level of the measurement current, select a range using a lower measurement current.

- ! The measurement target may melt (such as a fuse or inflator).
- ! The measurement target may heat up, causing a change in resistance.
- ! The measurement target may be magnetized, causing a change in inductance.

Within each of the measurement ranges, the power for the measurement target can be expressed by “resistance x (measurement current)<sup>2</sup>”. If the measurement range is deviated, the power may reach the value of “open-circuit voltage x measurement current” at maximum.

Before connecting the measurement target, be sure to check the measurement range.

\* At the moment of connecting the measurement target, a maximum inrush current of 5 A flows.

(Convergence time: Approximately 1 ms for pure resistance)

3mΩ > 30mΩ > 300mΩ > 3Ω > 30Ω > 300Ω > 3kΩ > 30kΩ > 300kΩ > 3MΩ.

### Using the auto range

Use the **[AUTO]** key to switch to the auto range. (The default setting is AUTO.) When the instrument is in the auto range mode, AUTO is lit.

### The auto range



[AUTO] Toggles the auto range ON and OFF.

### The manual range



#### IMPORTANT

- I When the range is manually changed in the auto range mode, the auto range is automatically disabled and the manual range is enabled.
- I If the comparator function is turned ON, the range is fixed and cannot be changed. To change the range, turn the comparator function OFF or change the range in the comparator setting.
- I Depending on the measurement target, the auto range may become unstable. In such a case, specify the range manually or increase the delay time. For the measurement accuracy of each range, see “Resistance measurement accuracy”.

## 3.2 Connecting the Test Leads to the Measurement Target

---

### Example 9363-A Test clip

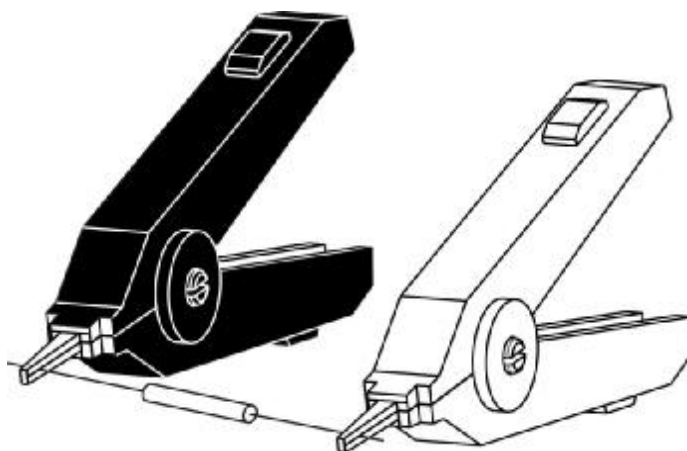

### Example 9363-B Test Probe

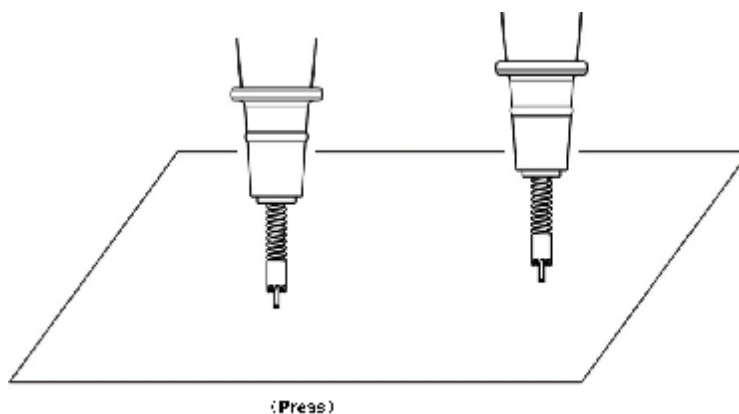

## 3.3 Reading the Measured Value

---

The instrument displays a resistance value. If a non-resistance value is displayed, see "Verifying measurement errors".

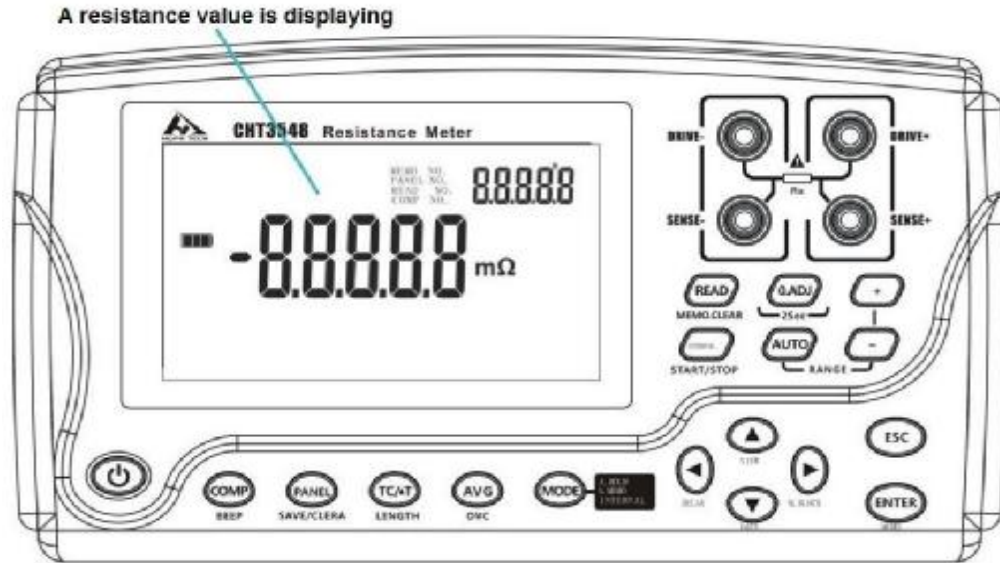

To convert the measured resistance value, see the following pages:

- I "5.2 Performing Temperature Rise Test (Temperature Conversion Function ( $\Delta T$ ))"
- I "5.3 Measuring the Length of a Conductor (Length Conversion Function)"

#### IMPORTANT

If the measured value has a negative sign (-), check the following:

- I The SOURCE and SENSE lead connections are reversed.
  - Ø Connect the leads correctly.
- I After zero adjustment for a two-terminal measurement, the contact resistance has decreased.
  - Ø Perform zero adjustment again.

#### Switching the display

Press and hold the **[+] (VIEW)** key to switch the type of information displayed on the upper right of the screen. (Temperature, no indicator, memory number (MEMORY No.))

The type of information displayed during measurements can be selected.

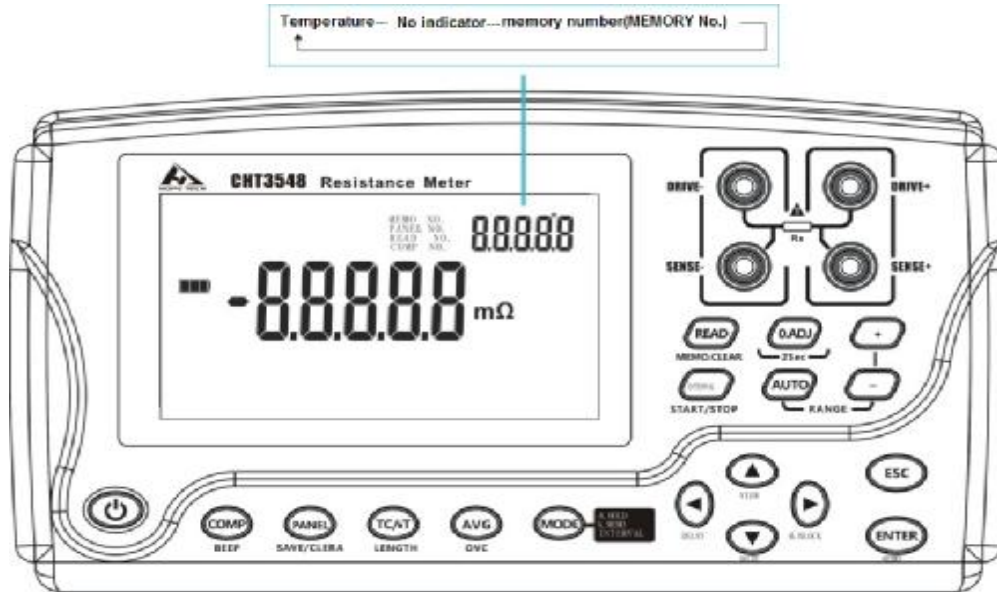

## Verifying measurement errors

If a measurement is not performed correctly, the measurement error is displayed on the screen.

### Out-of-range\*\*1



Indicates that the measurement or display range has been exceeded.

If oF is displayed, the comparator judgment is “Hi”, and if -oF is displayed, the comparator judgment is “Lo”.

In the same manner, oF is displayed when the temperature exceeds the measurement range during temperature measurement.

### Current fault or not measured yet

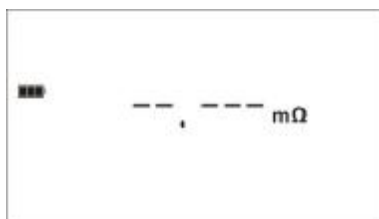

This screen is displayed in the following two cases.

If “-----” is displayed, comparator judgment is not performed.

1. Measurement current fault\*2

Current cannot be supplied to the DRIVE + or DRIVE - terminals.

2. No measurement has been performed after changing a measurement condition.

### The protection function is working

If an overvoltage is applied to a measurement terminal, the function for protecting the internal circuitry is activated in this instrument. If an overvoltage is accidentally applied, remove the test leads from the measurement target immediately. Measurement cannot be performed while the protection function is activated. In order to cancel the protection function, contact test lead DRIVE+ to DRIVE- or turn the power off and on.



### Fuse blown out



Each SOURCE terminal of the instrument is equipped with a fuse to protect against overvoltage input. If an overvoltage is accidentally applied and a fuse is blown, replace the fuse.

### Temperature Sensor not connected

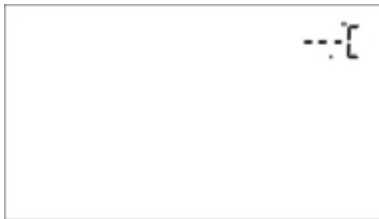

Temperature cannot be measured as the Temperature Sensor is not connected. When TC or  $\Delta T$  is not used, it is not necessary to connect the Temperature Sensor. If the temperature is not to be displayed, switch the display by pressing the **[+]** (VIEW) key.

### Temperature calculation error



The Temperature Sensor is not connected even when TC or  $\Delta T$  is ON, or oF is displayed for the temperature. Check the connection of the Temperature Sensor.

#### IMPORTANT

If the measurement target is connected to the SOURCE terminal, but a SENSE terminal has a bad contact, the displayed measured value may be unstable.

### \*1 Out-of-range detection function

## Examples detected as out-of-range

Out-of-range detection	Measurement examples
The measurement range is exceeded.	40 mΩ is measured in the 30 mΩ range.
The relative display (% display) of a measured value exceeds the display range (999.99%).	5000 (+2400%) is measured with a reference value of 200.
The A/D converter input range is exceeded during a measurement.	Such an error occurs, for example, if a high resistance is measured in an environment with external noise.
The calculation result cannot be displayed.	The calculation result for the length conversion function exceeds 999.99 km.

## \*2 Current fault detection function

### Current fault examples

- I The DRIVE+ or DRIVE- probe is open.
- I The measurement target has a broken wire (open-circuit work).
- I The DRIVE+ or DRIVE- wiring has a broken wire or a bad connection.

### IMPORTANT

A wiring resistance exceeding the following value in each range causes a current fault, making the measurement impossible. In the 1 A measurement current range, reduce the resistance of the wiring and contact between the measurement target and test leads.

Range (Ω)	3m	30m	300m	3	30	300	3k	30k~3M
Wiring and contact resistance (Ω)	0.5		10		100	2k	800	2k

## Holding a measured value

The auto-hold function helps to verify a measured value. When the measured value becomes stable, the value is automatically held.

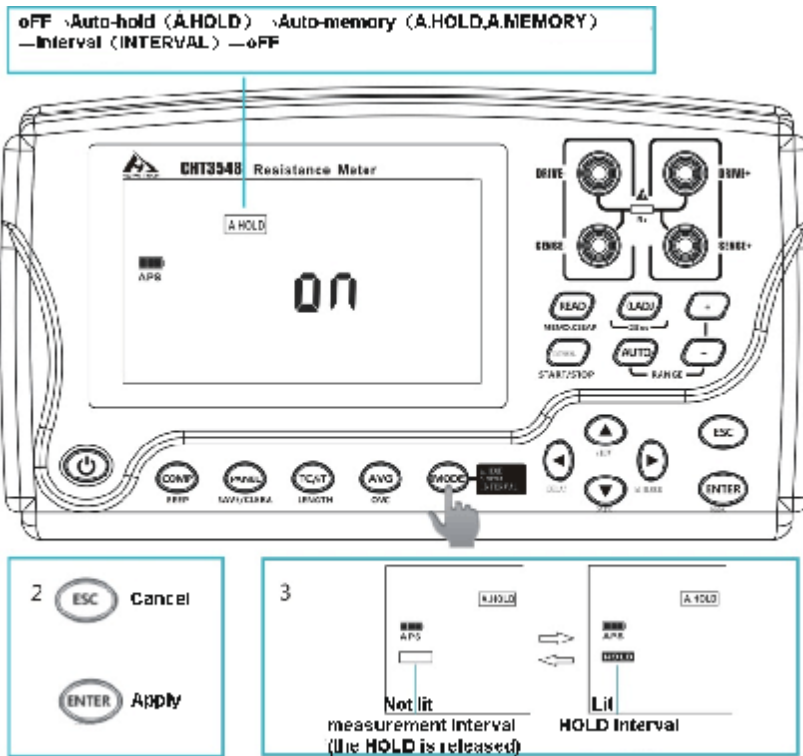

### Save a measured value

The storage function helps to verify a measured value later. It saves the displayed measured value.

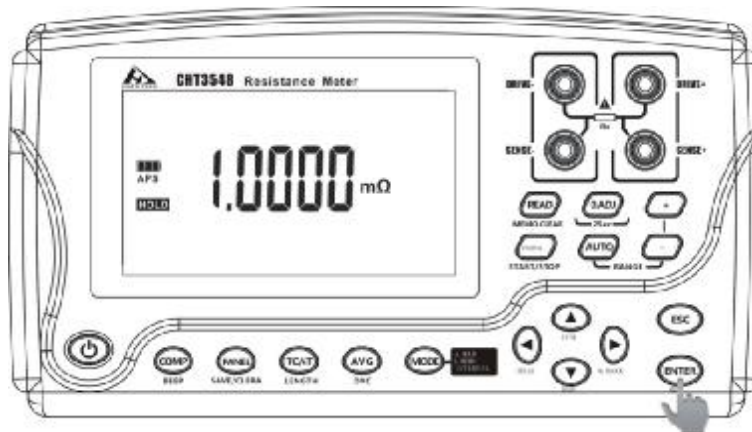

For more details about the save function, see “Saving Data at Specified Time (Manual Memory)”

## Chapter 4 Customizing Measurement Conditions

This chapter describes the functions useful to perform more sophisticated and accurate measurement.



## 4.1 Using Zero Adjustment

---

In the following cases, perform zero adjustment:

(A resistance of up to  $\pm 3\%$ f.s. can be canceled for any range.)

- I The measurement value is not cleared due to thermal EMF or other factors.
  - Ø The measurement value will be changed to zero.  
Accuracy is not affected by whether or not the zero adjustment is performed.  
The thermal EMF can also be canceled by using OVC.
- I Four-terminal connection (called Kelvin connection) is difficult.
  - Ø The residual resistance of the two-terminal connection wires will be canceled.

### IMPORTANT

- I When the ambient temperature changes or the test leads are replaced after zero adjustment, perform zero adjustment again.
- I Perform zero adjustment for each range used. In the manual range mode, only the current range is adjusted to zero. In the auto range mode, all ranges are adjusted to zero.
- I Zero adjustment values are held internally even if the instrument is power off, but they are not saved in the panel.
- I When the offset voltage compensation (OVC) function is turned from ON to OFF or from OFF to ON, the zero adjustment is cleared. Perform zero adjustment again.
- I When the measurement current is changed from Lo to Hi or from Hi to Lo, the zero adjustment is cleared. Perform zero adjustment again.
- I When a lower resistance is measured after zero adjustment, the measured value will be negative.

Example:  $2\text{m}\Omega$  is connected in the  $300\text{m}\Omega$  range and then zero adjustment is performed.

If  $1\text{m}\Omega$  is measured,  $-1\text{m}\Omega$  is displayed.





If the connection is wrong

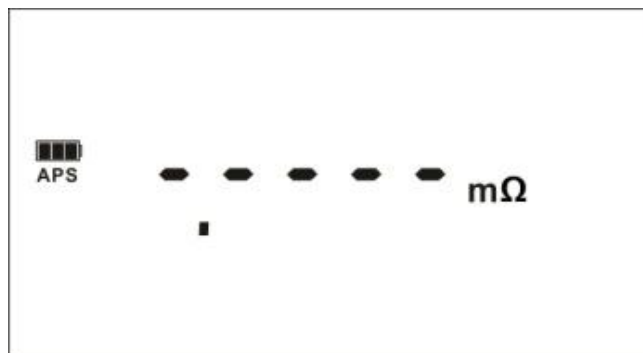

### 3. Press and hold the [0 ADJ] key to perform zero adjustment

If it is difficult to press the key as the Zero Adjustment Board is used, press the [0 ADJ] key before shorting the measurement lead. Zero adjustment is automatically performed after the measured value is stabilized.

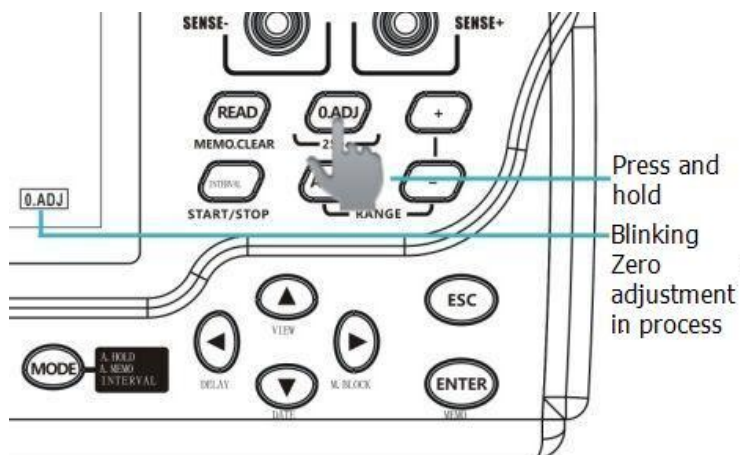

### 4. After zero adjustment

Zero adjustment has succeeded, the buzzer sounds and the measurement screen appear.

Indicator ON.



**Zero adjustment has succeeded**

The buzzer sounds and [FAIL] appears. Then, the measurement screen appears.

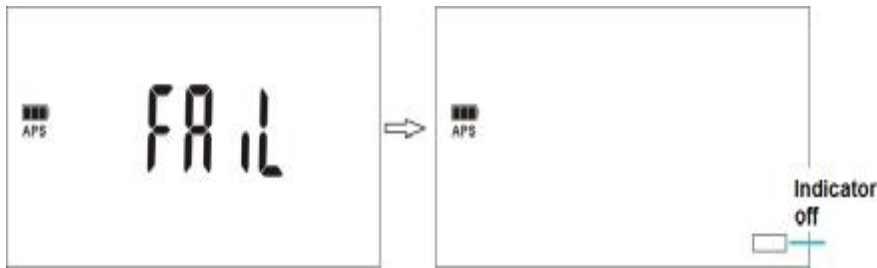

**Zero adjustment has failed**

When zero adjustment cannot be performed, the measured value before zero adjustment already exceeds  $\pm 3\%$  of the full scale of each range or the instrument is in a measurement error state. Perform zero adjustment with the correct wire connection again. If the resistance is too high (e.g., due to a self-made cable), zero adjustment cannot be performed. In such a case, try to minimize the wiring resistance.

**IMPORTANT**

If zero adjustment fails, the zero adjustment is cleared for the current range.

**Clearing zero adjustment**

When the power is off, while holding the [0 ADJ] key, press the [POWER] key to clear the zero adjustment for all ranges.

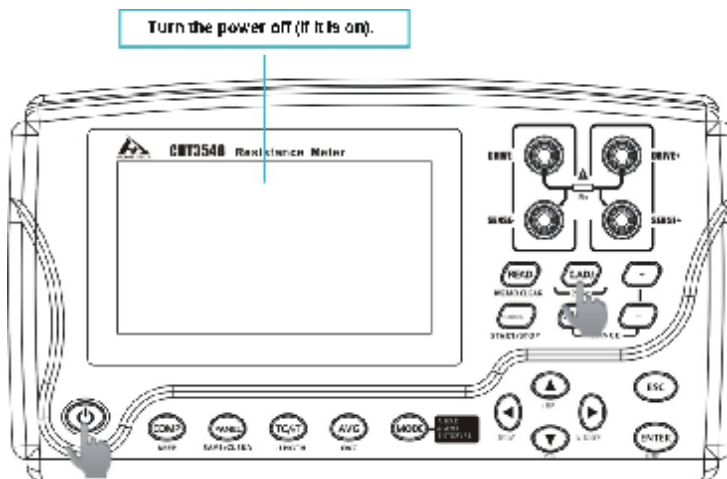

## 4.2 Stabilizing Measured Values (Averaging Function)

This function averages the measurement values in order to display a single value. It helps to stabilize fluctuations in the measured values.

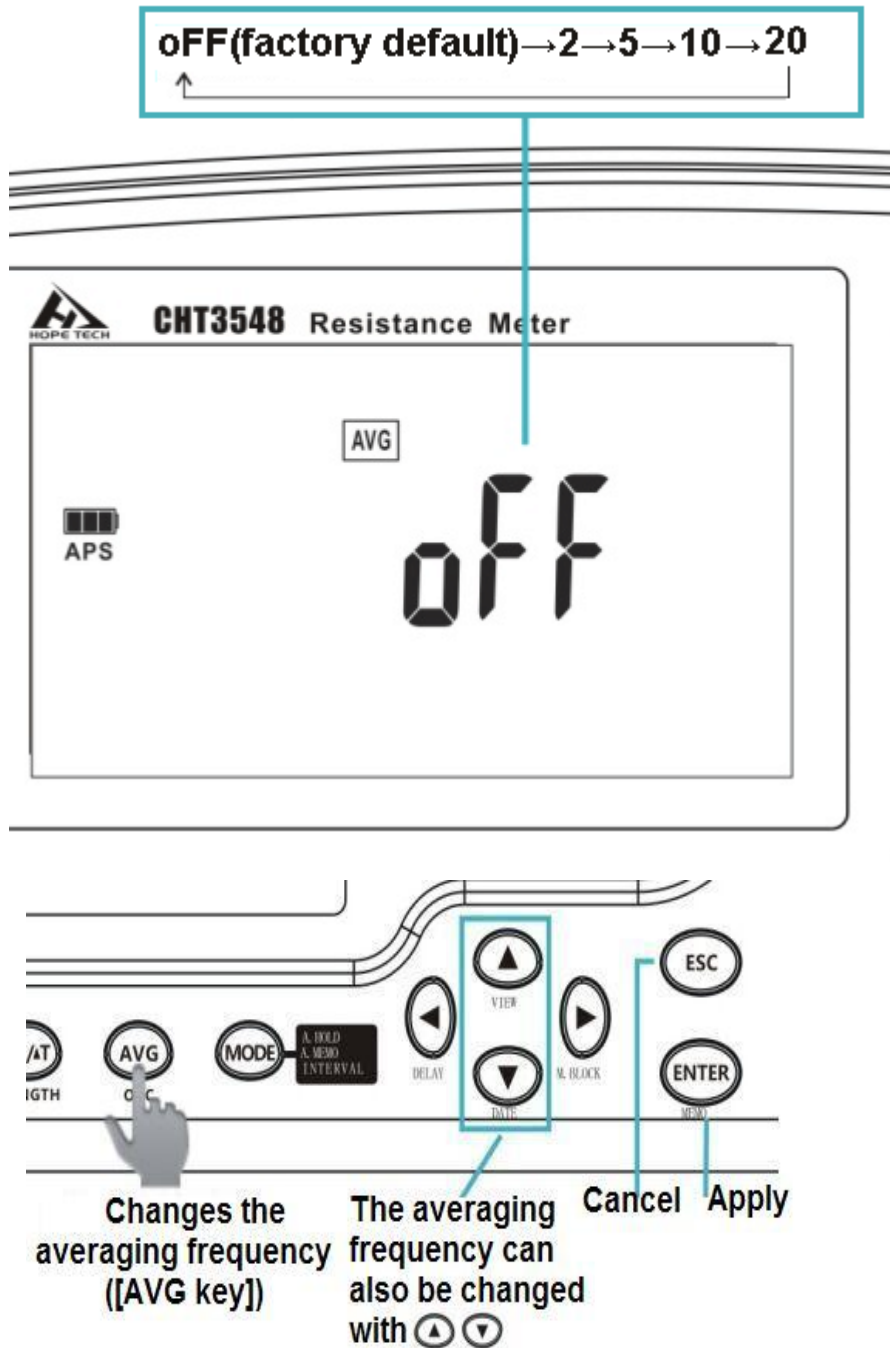

## 4.3 Compensating for Thermal Effects (Temperature Correction (TC))

Temperature correction converts the value of a resistance that depends on temperature, such as that of a copper wire, to a resistance value at a particular temperature to display it.

Resistances  $R_t$  and  $R_{t_0}$  below are the resistance values of the measurement target (having resistance temperature coefficient at  $t_0^\circ\text{C}$  of  $\alpha_{t_0}$ ) at  $t^\circ\text{C}$  and  $t_0^\circ\text{C}$ .

$R_t = R_{t_0} \times \{1 + \alpha_{t_0} \times (t - t_0)\}$	
$R_t$	Actual measured resistance [ $\Omega$ ]
$R_{t_0}$	Corrected resistance [ $\Omega$ ]
$t_0$	Reference temperature [ $^\circ\text{C}$ ]
$t$	Current ambient temperature [ $^\circ\text{C}$ ]
$\alpha_{t_0}$	Temperature coefficient at $t_0$ [ $1/^\circ\text{C}$ ]

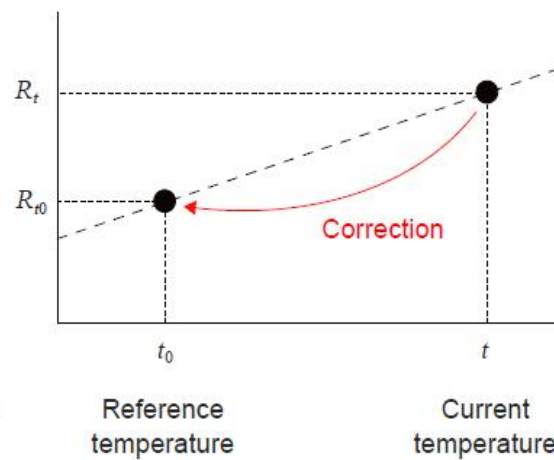

This function converts a measured resistance value, based on the reference temperature, to display the converted value. For the principles of temperature correction, see “Appx. Temperature Correction Function (TC)”.

To perform temperature correction, connect the Temperature Sensor to the TEMP.SENSOR terminal on the side of the instrument. Before connecting the sensor, be sure to read “Connecting the Temperature Sensor (When Using TC or AT)”.

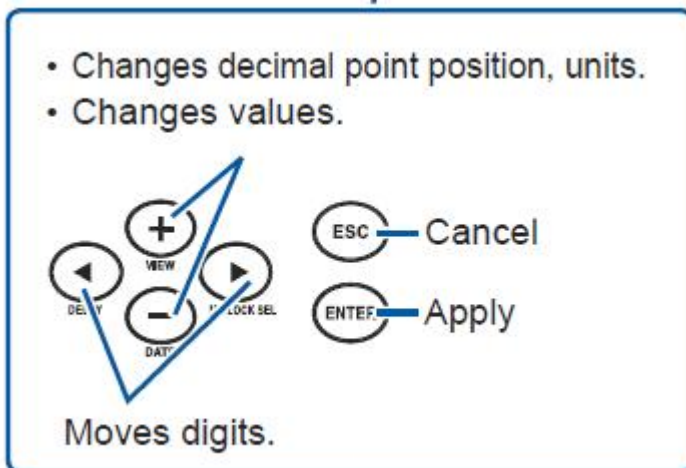
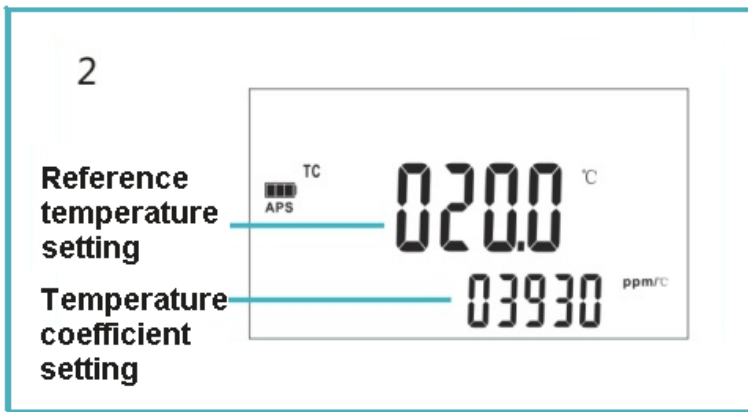
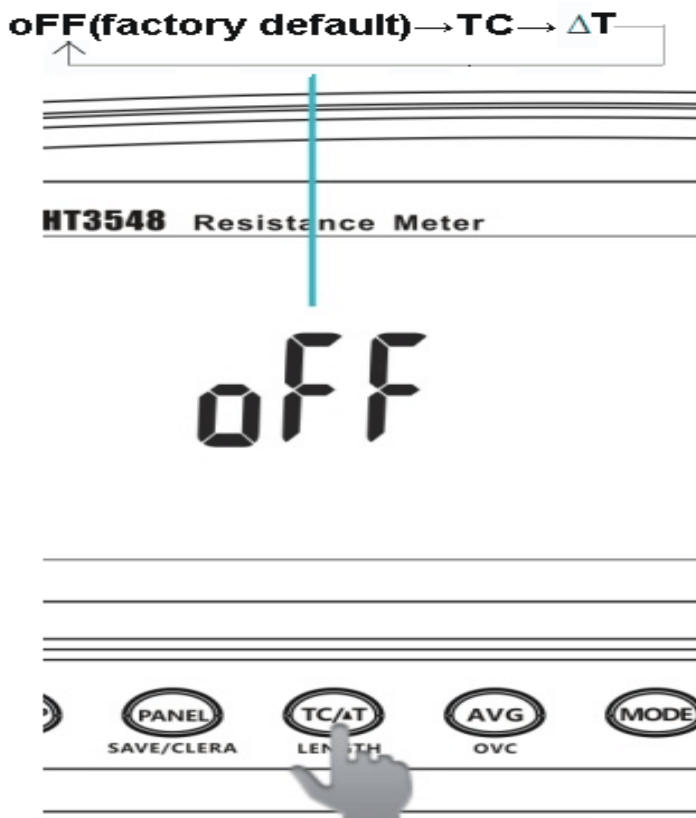

**IMPORTANT**

If the “t.Err” is displayed, the Temperature Sensor may not be connected, or Of is displayed for the temperature. Check the connection of the Temperature Sensor.

## 4.4 Compensating for Thermal EMF Offset (Offset Voltage

### Compensation Function: OVC Function)

---

This function automatically compensates for an offset voltage caused by thermal EMF or an internal offset voltage.

(OVC: Offset Voltage Compensation)

See: “Appx. Effect of Thermoelectromotive Force (Thermal EMF)”.

The function uses the resistance value measured when a measurement current flows, RP and that measured when no measurement current flows, RZ, to display the actual resistance value RP-RZ.



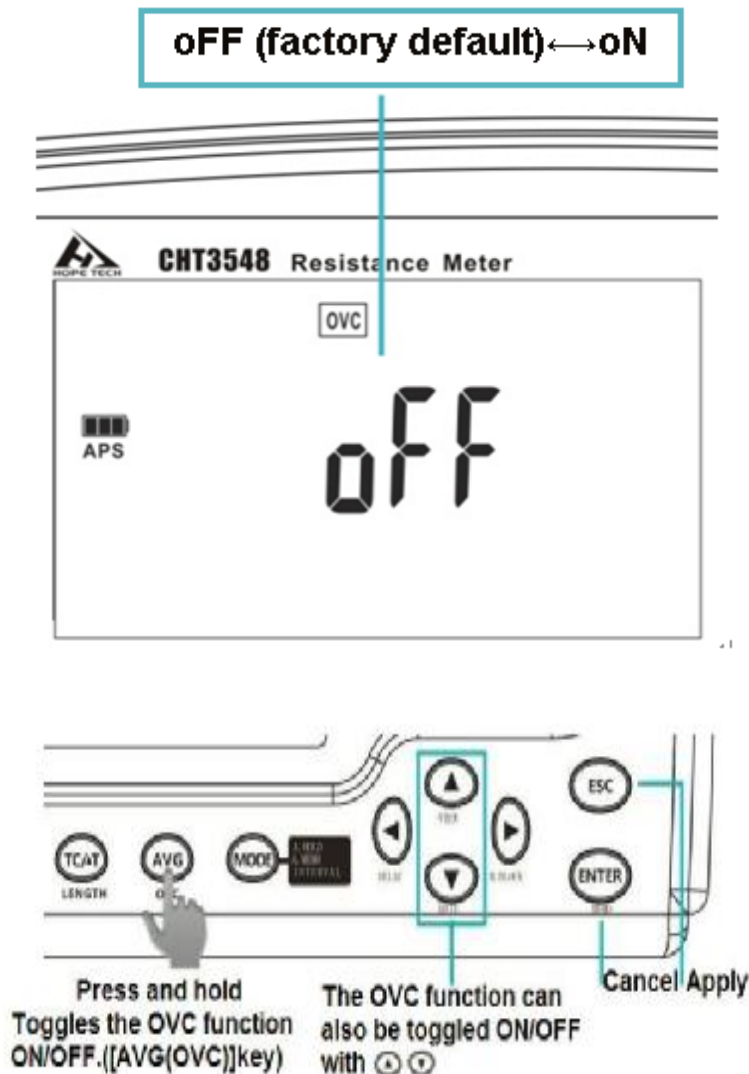

## 4.5 Setting the Delay Time for Measurement (Delay Function)

This function adjusts the time for measurement to stabilize by inserting a waiting period after use of the OVC or the auto range function to change the measurement current. When this function is used, the instrument waits for its internal circuitry to stabilize before starting measurement, even if the measurement target has a high reactance component.

### IMPORTANT

- I When the offset voltage compensation function is ON (the OVC indicator is lit), the measured value will be slow to refresh.
- I The OVC function cannot be used in the 3k $\Omega$  range or higher. The function is automatically turned OFF.
- I When the offset voltage compensation function is changed, the zero adjustment function is cancelled.

- I When the measurement target has a high inductance, it is necessary to adjust the delay time.
- I Start with a longer delay time than necessary, and decrease the time gradually, watching the measured value.
- I If the measurement target has a low heat capacity, the offset voltage compensation function may have no effect.

The PrSEt (preset value) depends on the range used and the offset voltage compensation function.

Preset OVC delay value (factory default) (Unit: ms)

Measurement current	Range	Delay time
Lo	3mΩ~30mΩ	200
	300mΩ ~ 3Ω	50
	30Ω ~ 300Ω	30
Hi	300mΩ	200

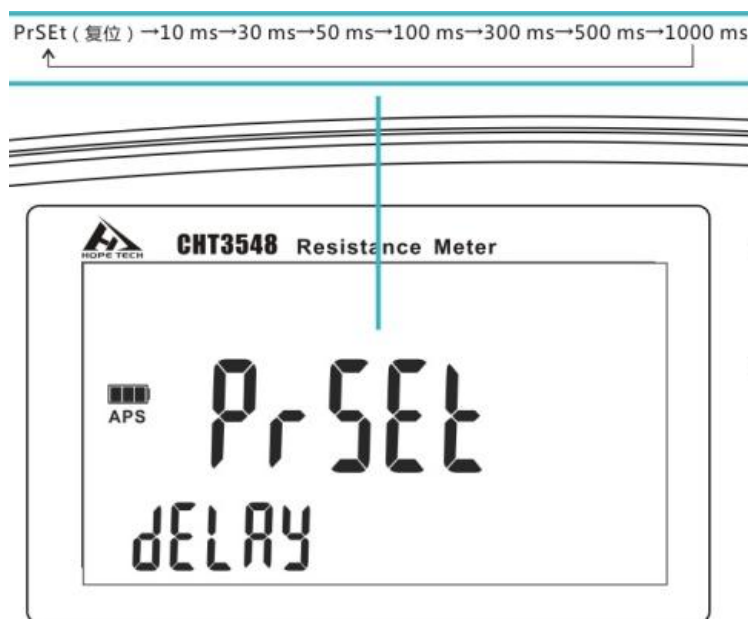

### Delay time guideline

If the measurement target, for example, is an inductor that takes longer to stabilize after applying a measurement current, and it cannot be measured with the initial delay (preset), adjust the delay. Set the delay time to approximately ten times the following calculation so that the reactance component (inductance or capacitance) does not affect the measurement.

$$t = -\frac{L}{R} \ln\left(1 - \frac{IR}{V_0}\right)$$

L: Measurement target inductance

R: Measurement target resistance + lead wire resistance + contact resistance

I: Measurement current (see: "Accuracy")

V<sub>0</sub>: Open-circuit voltage (see: "Accuracy")

Start with a longer delay time, and decrease the time gradually, watching the measured value.

As the delay is longer, the measured value display is slower to refresh.

#### 4.6 Switching the Measurement Current (In the 300mQ Range)

With this instrument, the measurement current for the 300mQ range can be changed to 300 mA (100 mA at the time of shipment from the factory). This makes it possible to measure large current wiring under conditions that are similar to the actual usage conditions. It is also useful when performing measurement in an environment with external noise.

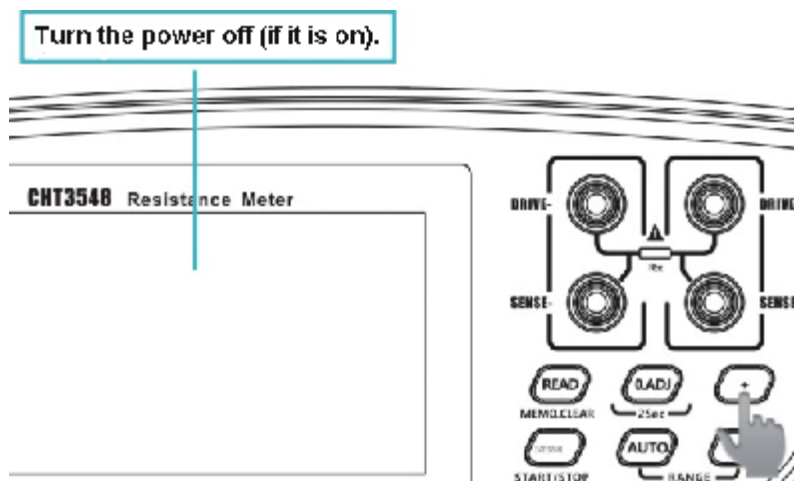

2 Make sure that the power is off, and holding down the , press the  key.

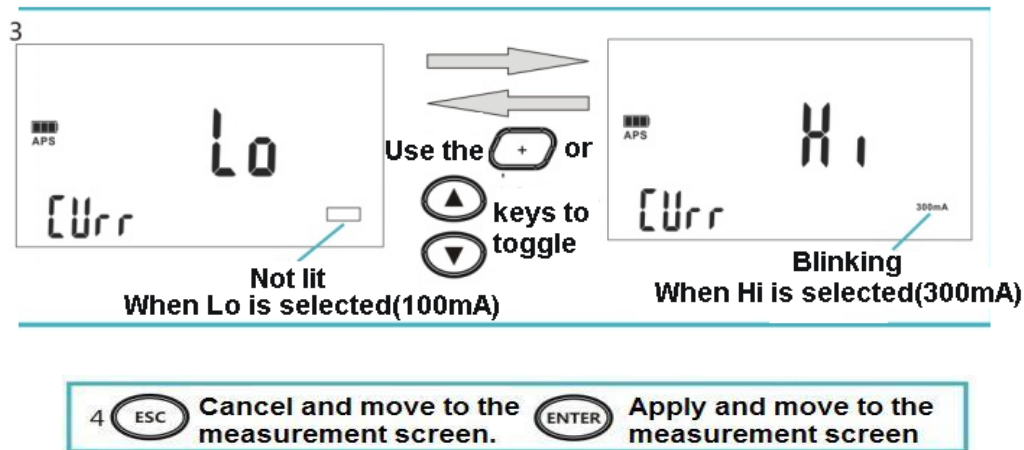

When measurement is performed with the 300 mA measurement current, the 300 mA indicator lights up

\*1 When measuring resistance for connection sections (e.g., connector contact, welded section, caulked section, screw-secured section) through which large current flows, such as power supply cables and ground cables, it is desirable that measurement be performed using the maximum current, as far as possible, that can actually flow through those sections. The following explains the reasons:

- I Even in a connection completely free from abnormality, a relatively high resistance may be indicated at a lower measurement current. This is due to an oxide film that is generated around the contact while it is not used.
- I Even when it is judged that no abnormality is found using a small current, the connection sections are occasionally melted when a large current flows. This problem occurs due to the Joule heat generated by a large current when a high resistance area is created locally.

## Chapter 5 Judgment and Conversion Functions

This chapter describes the measured value judgment and conversion functions.

### 5.1 Judging Measured Values (Comparator Function)

This function judges a measured value to be Hi (measured value > upper limit), IN (upper limit > measured value > lower limit), or Lo (lower limit > measured value) against the set reference value, or upper or lower limit values.

The judgment result can be verified on screen, with the buzzer (factory default is OFF), and the L2105 LED Comparator Attachment (option).

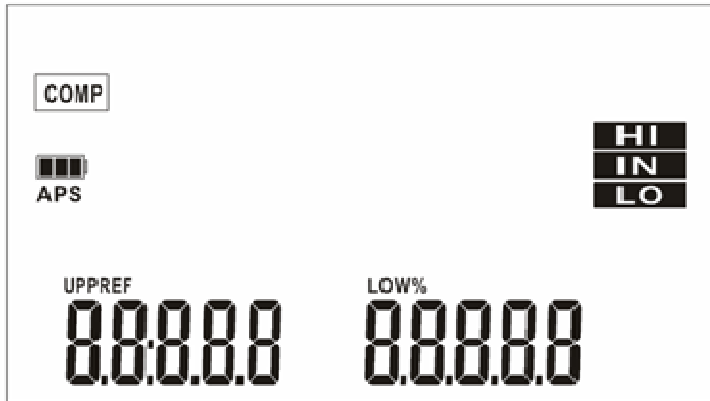

There are two different judgment methods available: ABS mode and REF% mode.

**IMPORTANT**

- I If AT or length conversion function is turned ON, the comparator function automatically turns OFF.
- I If the comparator function is set to ON, it becomes impossible to change the range (including the auto range). To use the auto range or change the range, set the comparator function to OFF, and then use the [AUTO] key or [▲][▼] keys.
- I If the comparator function is set to ON, the interval memory function becomes unavailable.

**Before using the comparator function**

If no measured value appears, the comparator judgment is displayed as follows: If a measurement error occurs, judgment is not performed

Display	Comparator judgment display (COMP lamp)
oF	Hi
-oF	Lo
-----	No judgment

If the power is turned off during a setting process, any setting changes are lost and the previous values remain valid. To apply the changes, press the **[ENTER]** key

**ABS (absolute value judgment) mode**

Set the upper and lower limit values for judgment, as absolute values.

**Example:**

Upper limit value.....100.00 mΩ  
 Lower limit value.....80.00 mΩ

Upper limit value .....100.00 mΩ

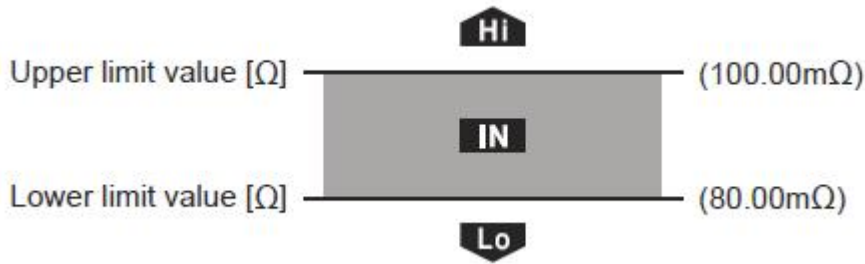

**REF% (relative value judgment) mode**

Set the allowable % of a reference value to determine the upper and lower limit

values for judgment. In REF% mode, the upper and lower limit values cannot be set separately.

**Example:**

Reference value.....12.000kΩ

Upper and lower limit values.....±1.00%

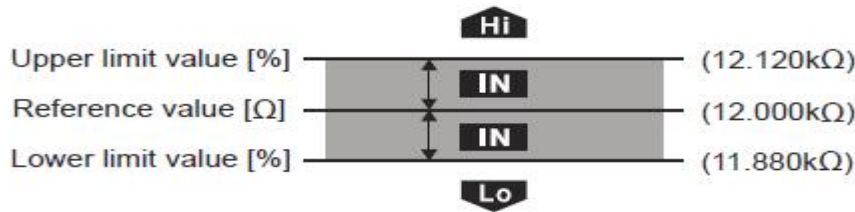

**Turning the comparator function ON/OFF**

OFF



**ABS mode**



Upper limit value    Lower limit value    Measurement range

### REF% mode



### Judging based on upper and lower limit values (ABS mode)

1 Use the **COMP** key to change the comparator to ABS mode

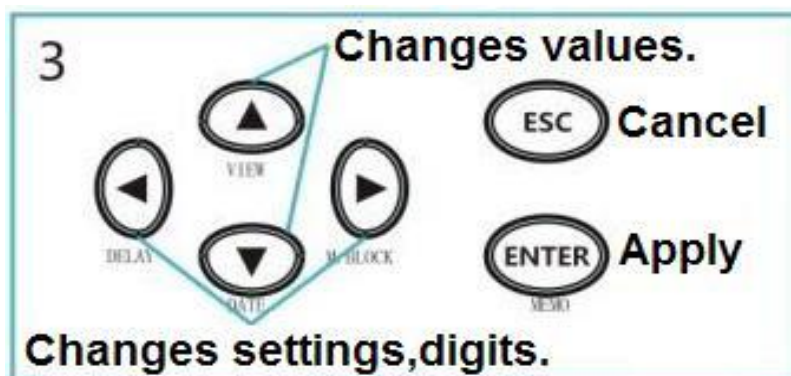
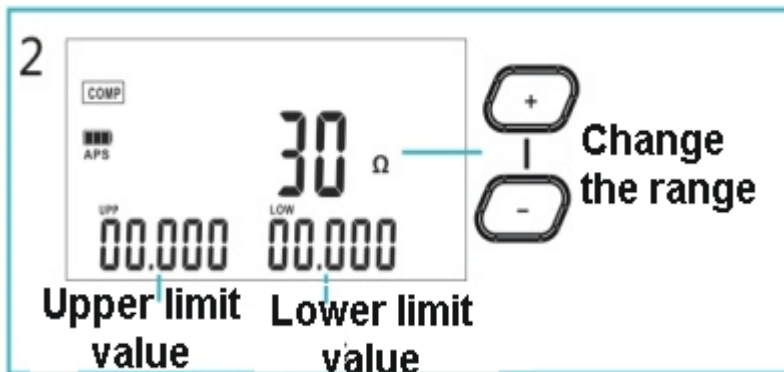
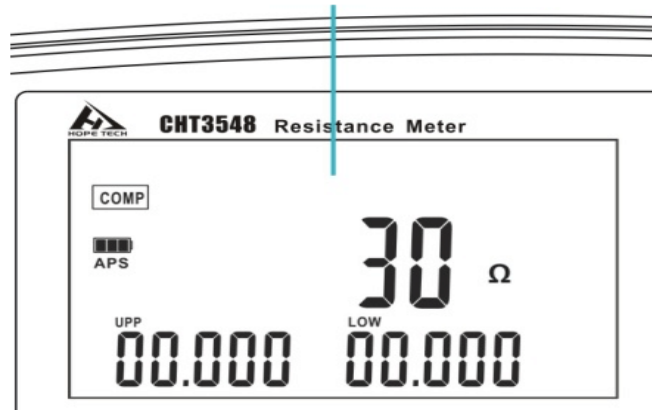

### IMPORTANT

Any setting changes cannot be applied when: upper limit value < lower limit value.

### Judging based on a reference value and allowable range (REF% mode)

In REF% mode, a measured value is displayed as a relative value. The upper and lower limit values cannot be set separately.

$$\text{Relative value} = \left( \frac{\text{Measured value}}{\text{Reference value}} - 1 \right) \times 100[\%]$$

1 Use the **COMP** key to change the comparator to REF% mode

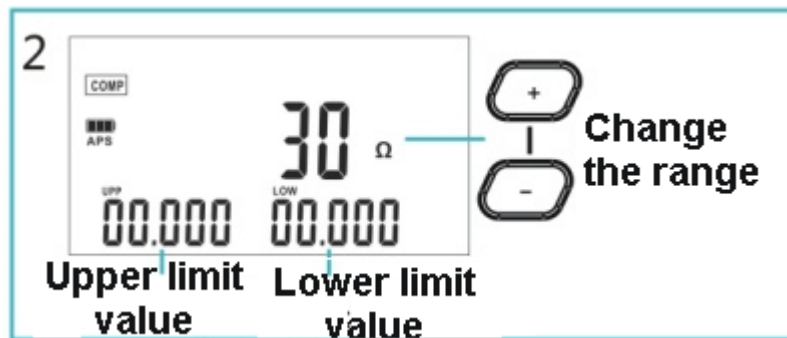
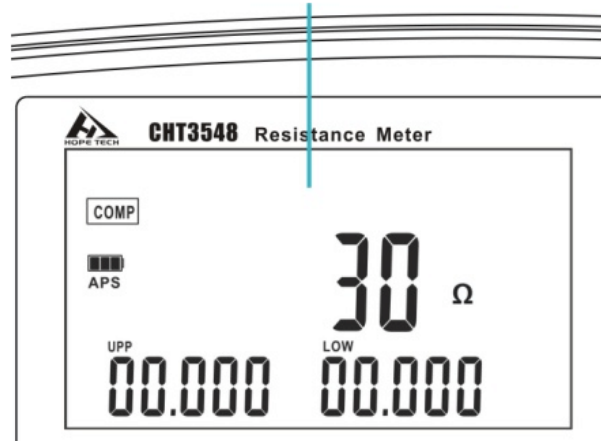



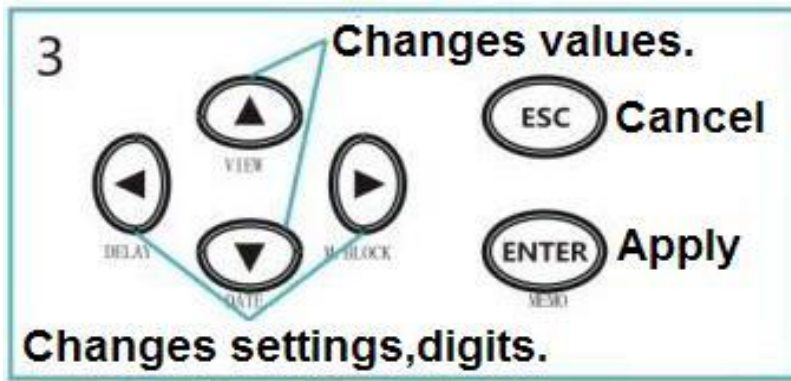

**IMPORTANT**

The settings cannot be confirmed when the reference value is set to 0.

**Verifying a judgment with a sound (judgment sound function)**

This function sounds the buzzer, based on a comparator judgment result.

oFF (factory default) → Hi → In → Lo → Hi-Lo

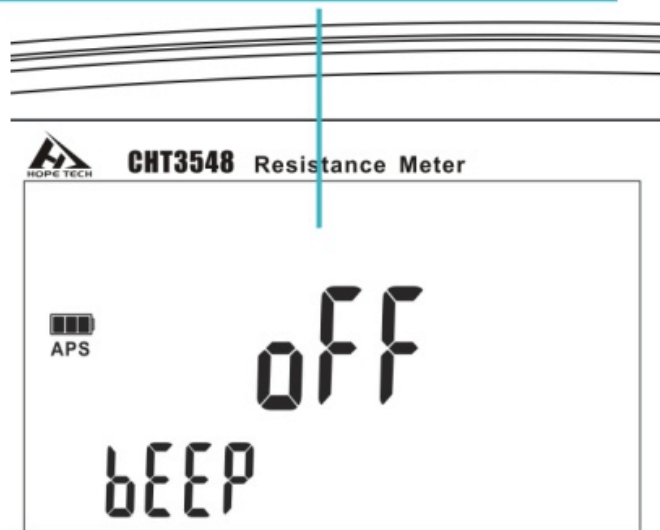

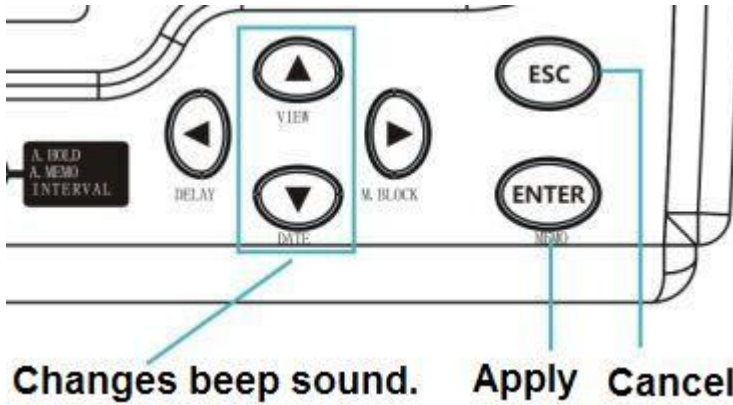

5.2 Performing Temperature

Rise Test (Temperature Conversion Function ( $\Delta T$ ))

This function converts the change in the winding resistance into a temperature rise value, based on the temperature conversion principle (p. Appx.7). It can be used to estimate the temperature of the motor or the inside of the coil while the power is cut off based on the change in the winding resistance.

**IMPORTANT**

- (1) After the motor and coil are stabilized at room temperature, measure the resistance ( $R_1$ ) and instrument ambient temperature ( $t_1$ ), and then input these values to the instrument.
- (2) Disconnect the test lead from the measurement target.
- (3) After turning off the power, reconnect the test lead to the measurement target and then measure the temperature rise value ( $\Delta t_1 \sim \Delta t_n$ , ) at the preset intervals. It can be measured easily if the interval memory function is used.)
- (4) Draw a line by connecting the collected temperature data ( $\Delta t_1 \sim \Delta t_n$ ), and estimate the maximum temperature rise value ( $\Delta t$ ).

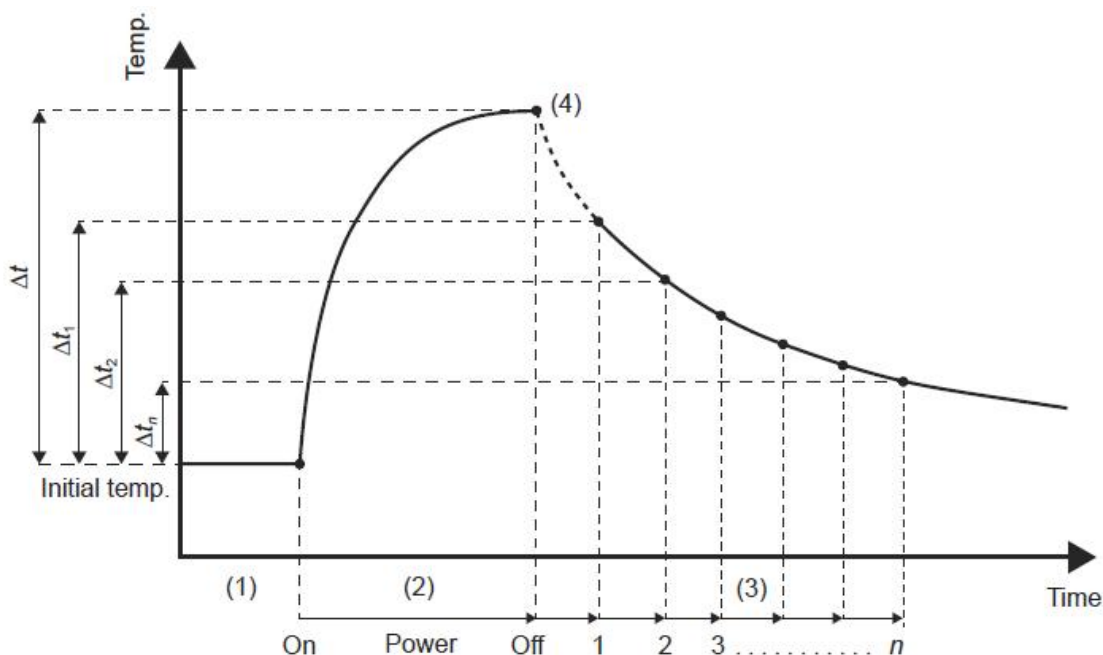

Performing Temperature Rise Test (Temperature Conversion Function ( $\Delta T$ ))

off (factory default) → TC →  $\Delta T$

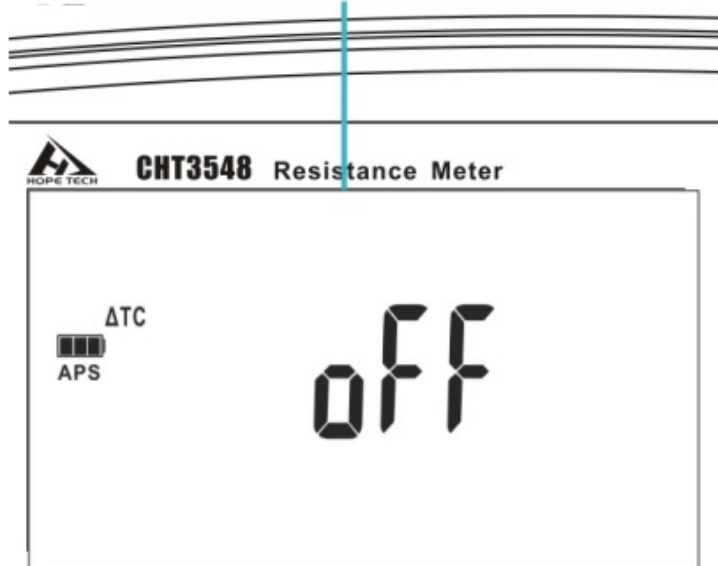

1 Use the  $\text{TC/AT}$  key to select  $\Delta T$ .

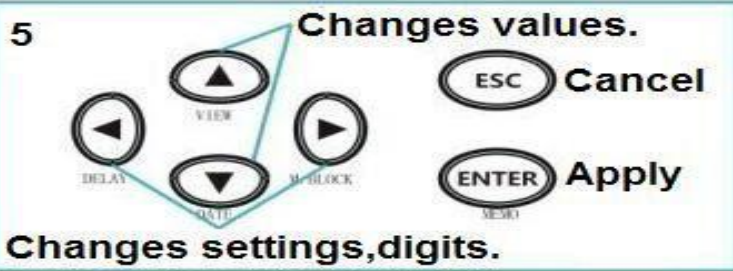
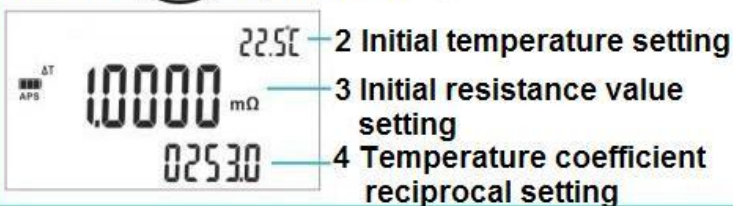

Measurement screen



### 5.3 measuring conductor length (length conversion function)

This function converts a resistance value to a length to display the length of the measurement target (such as a conductor).

Press and hold the **[TC/ΔT](LENGTH)** key to display the ON/OFF setting screen for the length conversion function.

$$\text{Length [m]} = \frac{\text{Measured resistance } [\Omega]}{\text{Per meter resistance } [\Omega/\text{m}]}$$

Example: When the measured resistance is 8Ω and per meter resistance is 100mΩ/m

#### IMPORTANT

When length conversion function is set to ON, the comparator cannot be turned ON. If ΔT is set to ON, length conversion function automatically turns OFF

#### Measuring the Length of a Conductor (Length Conversion Function)

oFF (factory default) ↔ ON (per meter resistance value setting)

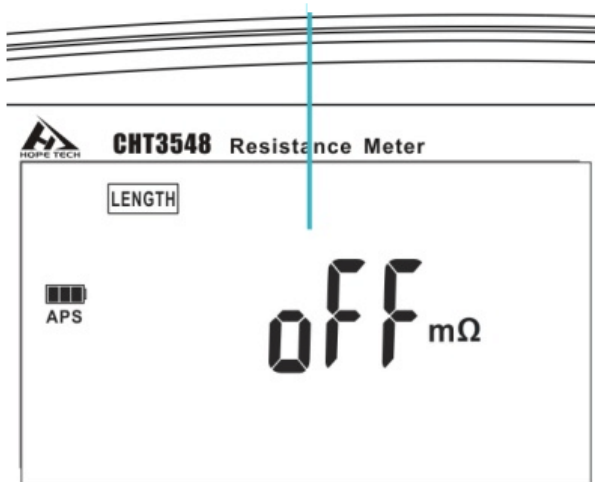

1 Press and hold the **TC/AT** key to select **LENGTH**

2



Changes decimal point position, units.

### IMPORTANT

The display format (decimal point position and unit) automatically changes depending on the range and setting. For details, see the product specifications. For some ranges, oF is always displayed, because the display range is exceeded, depending on the setting.

3

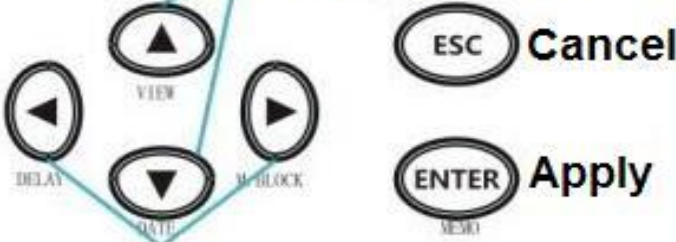

Changes values.

ESC Cancel

ENTER Apply

Changes settings, digits.

## Chapter 6 Panel Save and Load (Saving and Loading Measurement)

The panel save function can save up to nine sets of measurement conditions displayed at the time of the panel save operation, and the panel load function can load any set of the measurement conditions at any time. The panel data is retained even if the instrument is turned off.

Press the **[PANEL]** key to display the panel load screen.

Press and hold the **[PANEL]** (SAVE/CLEAR) key to display the setting screen for the panel save/clear function.

Conditions that can be saved by panel save:

Resistance measurement range, averaging, delay, comparator, judgment sound, temperature conversion ( $\Delta T$ ), measurement current change, length conversion, temperature correction (TC), OVC, and memory mode

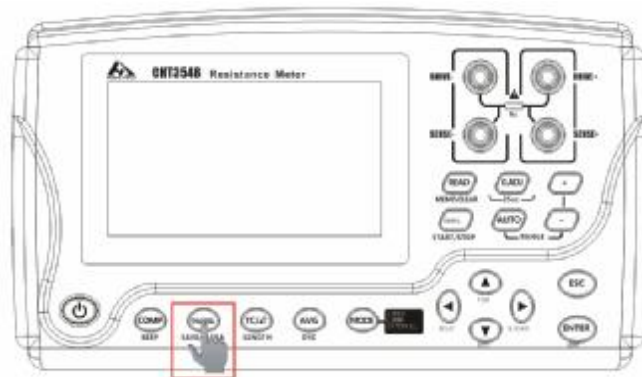

## 6.1 Save the measurement conditions (Panel save function)

This function saves the set of current measurement conditions.

- 1 Press the **[PANEL](SAVE/CLEAR)** key
- 2 Select SAVE
- 3 Select a panel number
- 4 Press the **[ENTER]** key, save and move to the measurement screen



### IMPORTANT

- I If the already saved panel number is selected and the **[ENTER]** key is pressed, the existing contents are overwritten.
- I Zero adjustment values are not saved.

## 6.2 Reads the measurement conditions (panel reading function)

This function replaces the current measurement conditions with a saved set of measurement conditions.

- 1 Press the **[PANEL]** key
- 2 Select a panel number

3 Press the **[ENTER]** key to load the measurement conditions, move to the measurement screen

**IMPORTANT**

- I If the number of a panel that is not saved is selected and the **[ENTER]** key is pressed, a warning sound is output.
- I Zero adjustment values are not read. Zero adjustment can be performed both before and after panel loading.
- I If PANEL No.PrSEt is selected, the measurement conditions are initialized. (Preset load)
- I The panel number is not displayed on the measurement screen.

### 6.3 Clearing the Contents of a Panel

- 1 Press and hold the **[PANEL](SAVE/CLEAR)** key
- 2 Select CLEAR
- 3 Select a panel number
- 4 Press the **[ENTER]** key to delete the panel, move to the measurement screen

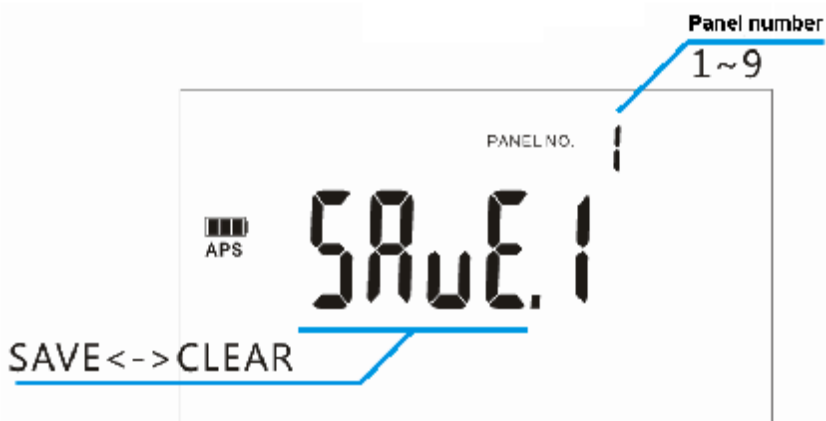

**IMPORTANT**

Once deleted, the contents of the panel cannot be restored.

## Chapter 7 Memory function

### What the memory function does

This function can save a value currently being measured. The saved data is held even if the instrument is turned off. There are three different saving methods:

- I Manual memory (up to 1,000 entries)
- I Auto memory (up to 1,000 entries)
- I Interval memory (up to 6,000 entries)
- I Data to be saved in the memory (Some items cannot be displayed only with the instrument.)

<b>Manual memory, auto memory</b>	Date and time, measurement value, temperature, resistance measurement range, averaging, comparator, changed measurement current, temperature correction (TC), and OVC
<b>Interval memory</b>	Start date and time, measurement value, temperature, resistance measurement range, averaging, temperature correction (TC), temperature conversion ( $\Delta T$ ), and interval

### Memory layout

Memory block (10 blocks)



(Maximum number of entries)

Manual or auto memory: 100 entries per block, a total of 1,000 entries for all blocks

Interval memory: A total of 6,000 entries for all blocks

(The number of memory in each block is not fixed.)

To save up to the maximum amount of memory shown above, all blocks should be used for the manual or auto-memory, or for the interval memory only. If both types of memory blocks exist, saving up to the maximum is not possible.

### Memory blocks

In manual or auto memory mode, the block to save data can be selected. In interval mode, data is saved in an available free block when the interval starts. In interval mode, the memory block to save data cannot be specified.

### Changing the memory block

- 1 Press the **[>](M.BLOCK)** key, to go to the memory block selection screen.
- 2 Rolling the **[▲]** or **[▼]** key to change the memory block.
- 3 Press the **[Enter]** key to move the measurement screen, or press the **[Esc]** key to cancel the measurement screen.



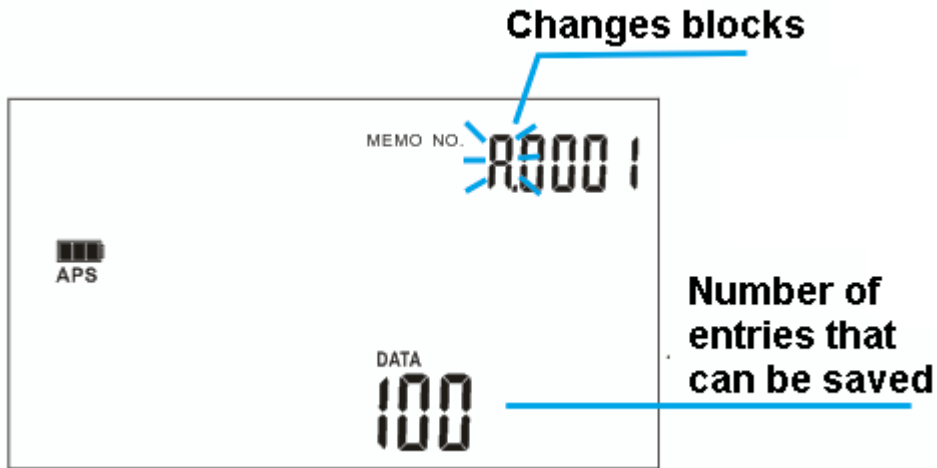

## 7.1 Press any timing to save (manual storage)

Press the **[ENTER] MEMO** key to save the displayed measured value

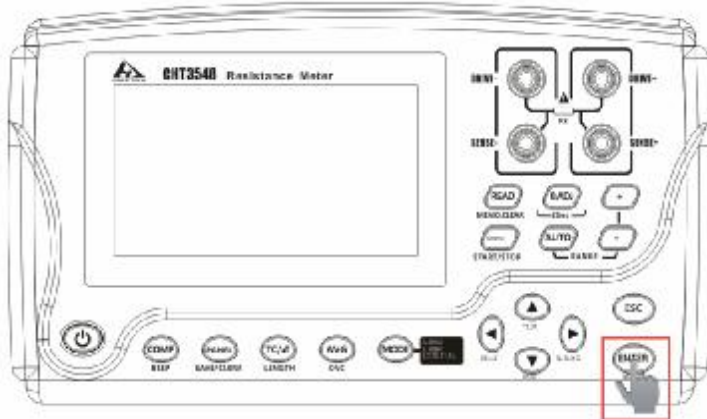

The memory number is incremented by one each time data is saved, and cannot be specified. If data is accidentally saved, clear the last data item saved (latest data)





## 7.2 After stable measurement values automatically save

When a measured value stabilizes, the value is automatically held and saved.

Press the **[MODE]** key to switch saving mode.

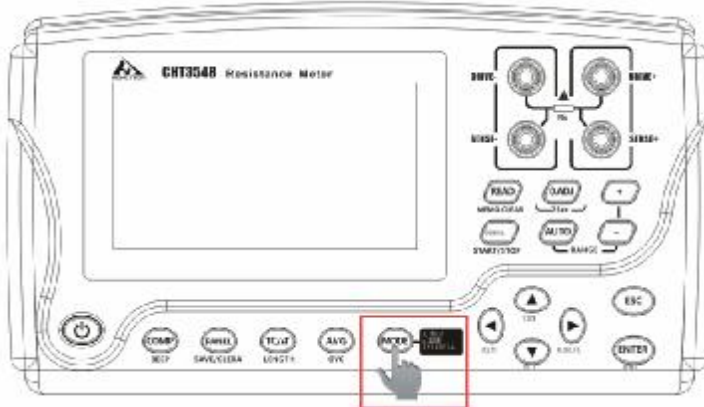

oFF → Auto-hold (A.HOLD) → Auto-memory (A.HOLD, A.MEMORY)  
 → Interval (INTERVAL) → oFF

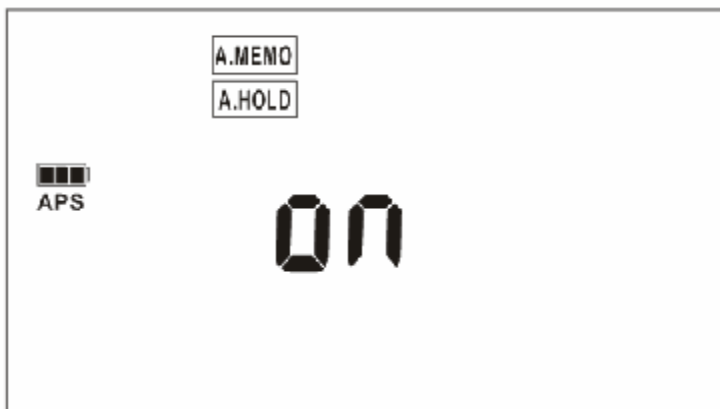

Press the **[ENTER]** key to confirm the saving mode; press the **[ESC]** key to cancel the selection.

The memory number is incremented by one each time data is saved, and cannot be specified. If data is accidentally saved, clear the last data item saved (latest data).

### 7.3 save at regular intervals (interval memory function)

This function can save measured data at specified intervals. Using this function together with  $\Delta T$  makes it easy to perform a temperature rise test (for estimation of power-off temperature).

Press the **[MODE]** key to switch the saving mode

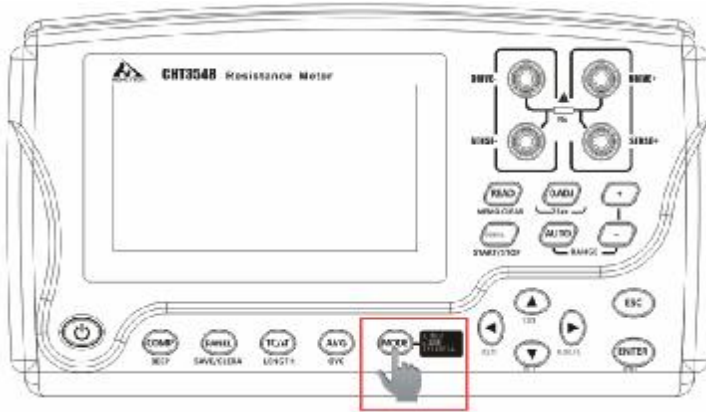

oFF→Auto-hold (A.HOLD) →Auto-memory (A.HOLD, A.MEMORY)  
 →Interval (INTERVAL) → oFF

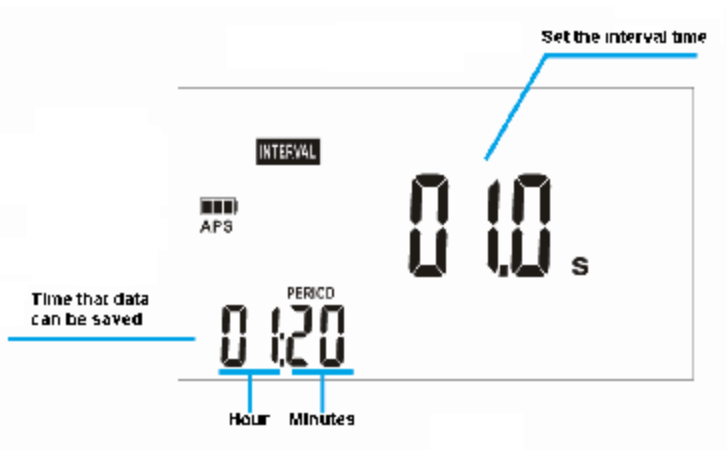

Press the **[▲][▼][←][→]** key to set the interval time.

Press the **[ENTER]** key to confirm the setting; press the **[ESC]** key to cancel the setting.

The time that data can be saved varies depending on the number of memory units already saved and the set interval time.

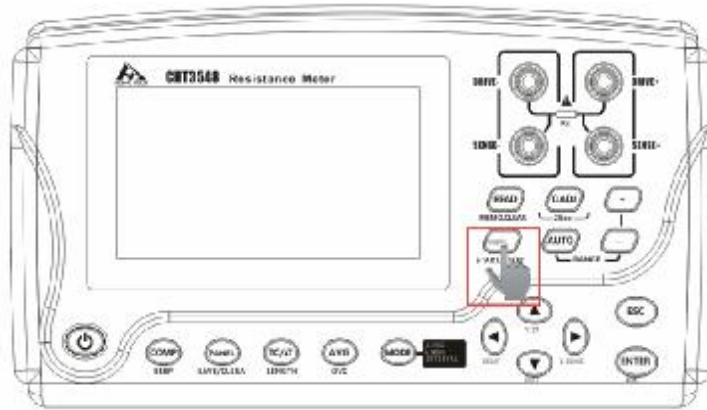

Press and hold **[INTERVAL]** key to start interval function; press and hold once again the **[INTERVAL]** key to stop the interval function.

#### IMPORTANT

- I When an interval measurement starts, data is automatically saved in an available free block. The memory block used cannot be changed. When the interval measurement stops, the used memory block displays FULL.
- I When the interval memory function is set to ON, the comparator function cannot be used. When the comparator is set to ON, the interval memory function cannot be used.

## 7.4 Display saved measurement data (stored display)

Press the **[READ]** key to display the saved measurement data.

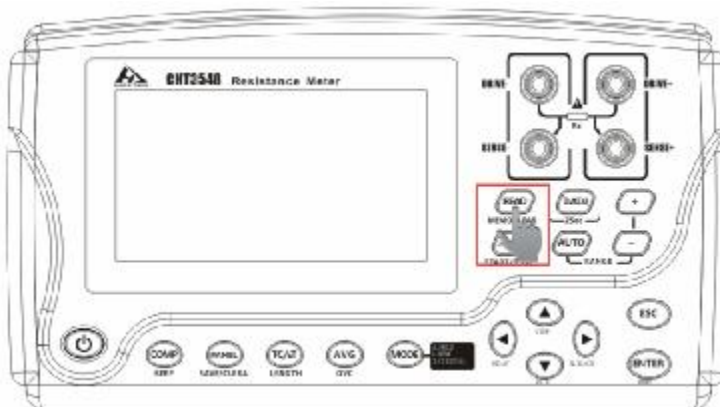

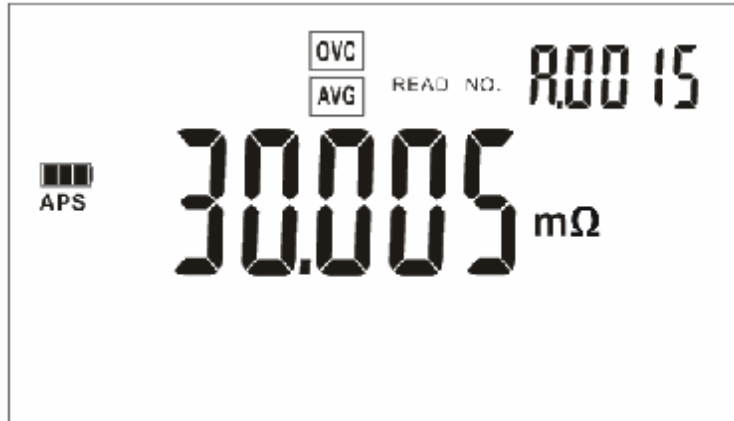

Press the **[▲][▼][←][→]** key to change the saved read number.  
 Press **[ENTER]** or **[ESC]** key to return measurement screen.

### 7.5 Delete saved measurement data (clear memory)

---

There are three different methods to clear saved measurement data.

- I Clearing only the last data (latest data) saved in a block
- I Clearing an entire block
- I Clearing all

Press and hold the **[READ]MEMO.CLEAR** key to display the clearing measurement data screen.

Clearing only the latest data saved in a block (block selectable)



Clearing an entire block of saved data

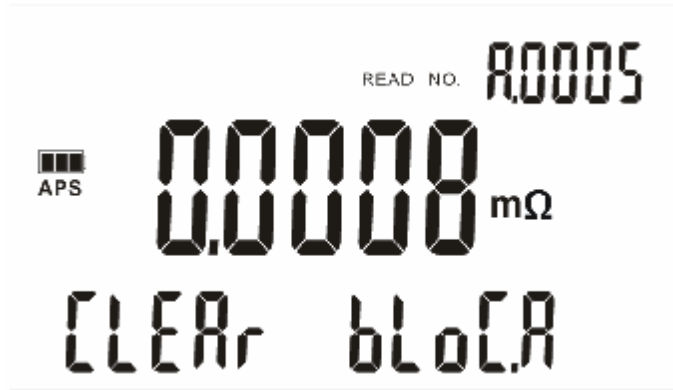

Clearing all



## 7.6 The saved measurement data read into the computer

Measured values stored in the memory are organized as files in CSV format.

Data saved in the internal memory can be exported to a PC, using USB mass storage mode.

### Connecting a USB cable

Be careful of the orientation of the USB cable plugs and connect the plugs to the instrument and PC.

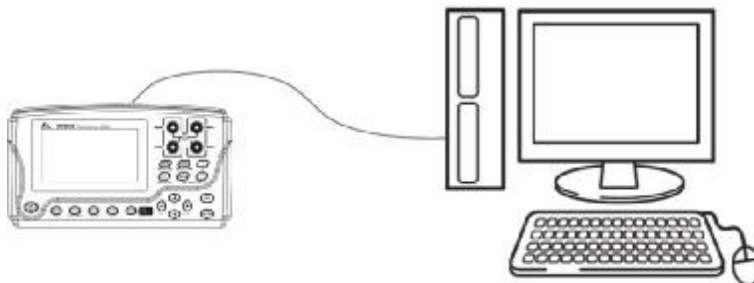

### Removing the USB cable

To remove the USB cable connected to the instrument while the PC is running, use the “Safely Remove Hardware” icon on the PC.

### Install desktop software

HT3548 desktop software.exe is green software. It works just by copying a file to the PC. Please make sure you’ve installed the framework 4.0 before you use the HT3548 desktop software. Otherwise, you cannot use it.

### Load the measurement data

Open HT3548 desktop software.exe, click the connection device. Select the port number in the pop-up dialog box.

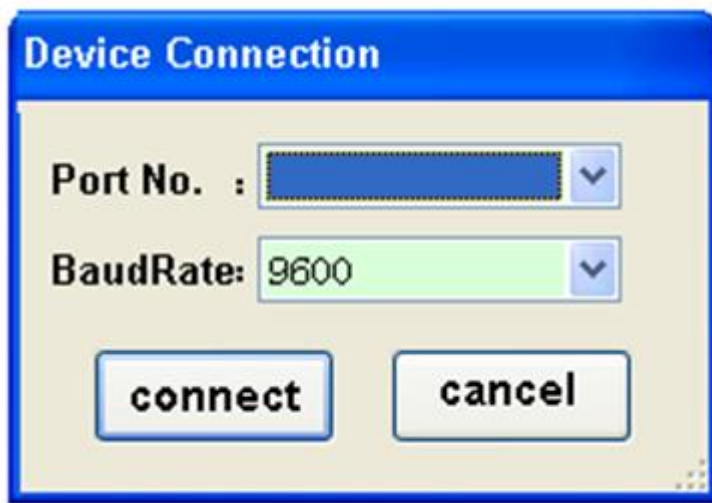

After the connecting successfully, click data to read measurement



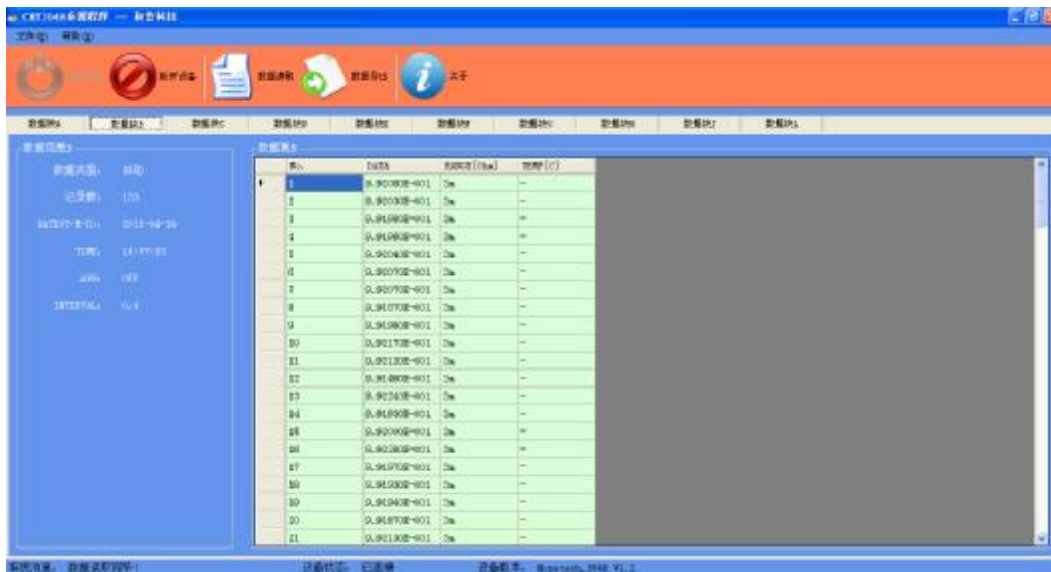

Click the data export; the data can be exported to a .CSV file.

ID	DATA	数据ID (ID)	数据 [C]
1	0.940000E+01	0%	--
2	0.940000E+01	0%	--
3	0.940000E+01	0%	--
4	0.940000E+01	0%	--
5	0.940000E+01	0%	--
6	0.940000E+01	0%	--
7	0.940000E+01	0%	--
8	0.940000E+01	0%	--
9	0.940000E+01	0%	--
10	0.940000E+01	0%	--
11	0.940000E+01	0%	--
12	0.940000E+01	0%	--
13	0.940000E+01	0%	--
14	0.940000E+01	0%	--
15	0.940000E+01	0%	--
16	0.940000E+01	0%	--
17	0.940000E+01	0%	--
18	0.940000E+01	0%	--
19	0.940000E+01	0%	--
20	0.940000E+01	0%	--
21	0.940000E+01	0%	--

## Chapter 8 System Settings

### 8.1 confirmation screen displays the date and time

Press and hold the [▼](DATE) key to verify the date and time



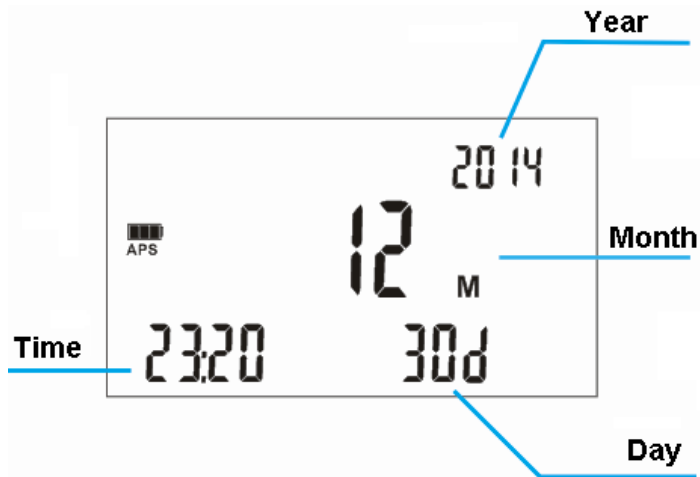

Press the **[Esc]** or **[Enter]** key to return the measurement screen.

## 8.2 calibration clock

Set the date and time.

To display the time setting screen, press and hold the **[▼](DATE)** key in date and time state.

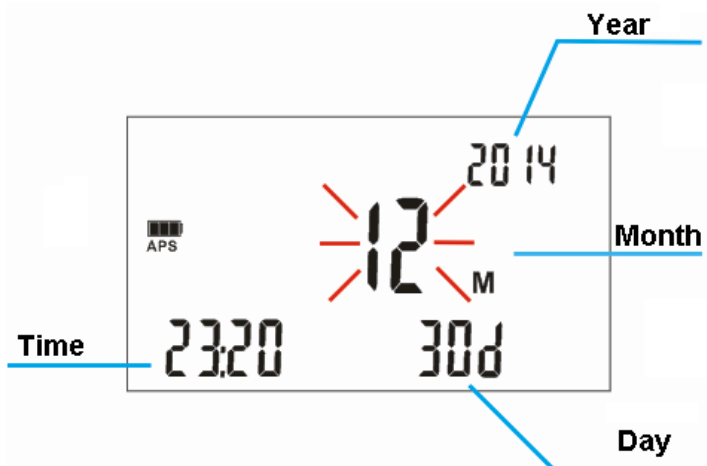

Press **[←] [→]** key to switch the digits, items, press the **[▲] [▼]** key to change the values.

Press the **[Enter]** key to confirm and switch the time and date screen.

Press the **[Esc]** key to cancel and switch the time and data screen.

### 8.3 initialized (reset)

---

This function provides the following three types of reset:

- Memory clear: Initializes the memory that stores measurement data. (This type of initialization is possible even if the power is on.)



Reset (to reset the current measurement conditions): Resets data and settings other than the panel data, saved measurement data, and the clock settings to the factory defaults.



System reset: Resets all settings other than the clock settings, including the panel data and saved measurement data, to the factory defaults.

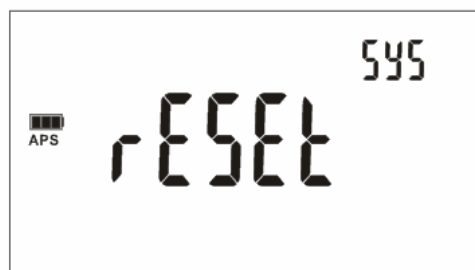

## Chapter 9 Parameter

### 9.1 General Specification

#### Function:

<b>Measurement items</b>	ESR
<b>Basic accuracy</b>	0.1%±10 reading (3mΩ,30mΩ,3MΩ) 0.05%±4 readings,0.02%±2 readings(the other ranges)
<b>Measurement range</b>	3mΩ/30mΩ/300mΩ/3Ω/30Ω/300Ω/3kΩ/30kΩ/300kΩ/3.3MΩ
<b>Measurement speed</b>	5 meas/sec
<b>Maximum test current</b>	DC 1A
<b>Temperature</b>	Range:-10°C ~60°C Accuracy:1°C
<b>Correction</b>	Short-circuit reset for all ranges
<b>Comparator</b>	HIGN/IN/LOW sorting
<b>Internal data storage</b>	Store up to 6000 test data
<b>Trigger</b>	Internal/auto trigger
<b>Signal source</b>	AC 1kHz, Test current: <150mA
<b>Range</b>	Resistance: 3mΩ/30mΩ/300mΩ/3Ω Voltage: 6V/60V
<b>Sampling rate</b>	1 meas/sec (the average number optional)
<b>Minimum resolution</b>	Resistance: 0.1μΩ Voltage: 0.1mV
<b>Maximum reading</b>	Resistance: 33,000 Voltage:60,000
<b>Other functions</b>	OVC,length conversion function,temperature correction,auto trigger,auto save,auto trigger save function
<b>Interface</b>	USB, external
<b>Power supply</b>	12V/1700mAh lithium battery, AA (LR6) Alkaline Batteries x 8
<b>Dimensions</b>	208 mm (L) x120mm (W) x 52mm (D),without sleeve
<b>Accessory</b>	CHT9365/CHT9363-A/CHT9363-B/CHT9367/CHT9366/CHT8301(100mΩ)
<b>Weight</b>	0.81kg
<b>Model</b>	HT3548 Portable Resistance Tester

#### Clock:

<b>Clock</b>	24-hour clock ,automatic adjust for leap year
<b>Accuracy</b>	Appro. +/- 4 minutes per month
<b>Other</b>	Internal spare lithium batteries Battery life: about 2 years

## 9.2 Accuracy

The following data was obtained under the following conditions:

Temperature condition: 23 °C ± 5 °C

Humidity condition: 80% R.H.

Warm-up time: > 15 minutes

Calibration Time: 1 year

Range	Max. reading	Resolution	Accuracy	Measurement Current
3mΩ	3.200 0mΩ	0.1μΩ	± 0.1 %rdg. ± 8 dgt.	1A
30 mΩ	32.00 0mΩ	1μΩ	±0.1%rd g. ± 8 dgt.	
300 mΩ	320.0 0mΩ	10μΩ	± 0.1 %rdg. ± 3 dgt.	300mA
	320.0 0mΩ	10μΩ	± 0.05 %rdg. ± 3dgt.	100mA
3Ω	3.200 0Ω	0.1mΩ	± 0.02 %rdg. ± 1 dgt.	100mA
30Ω	32.00 0Ω	1mΩ	± 0.02 %rdg. ± 1 dgt.	10mA
300 Ω	320.0 0Ω	10mΩ	± 0.02 %rdg. ± 1 dgt.	1mA
3kΩ	3.200 0kΩ	0.1Ω	± 0.02 %rdg. ± 1 dgt.	1mA
30k Ω	32.00 0kΩ	1Ω	± 0.02 %rdg. ± 1 dgt.	100μA
300 kΩ	320.0 0kΩ	10Ω	± 0.05 %rdg. ± 3dgt.	5μA
3M Ω	3.200 0MΩ	100Ω	± 0.2 %rdg. ± 8 dgt.	500nA

**Measurement Temperature:**

Range	Ma x. reading	Resolu tion	Accu racy	Measure ment Speed
-10°C~99 .9°C	9°C	0.1°C	±1°C	5 meas/sec

## Chapter 10 Accessories

---

The following length unit is mm.

### 9363-A test clip

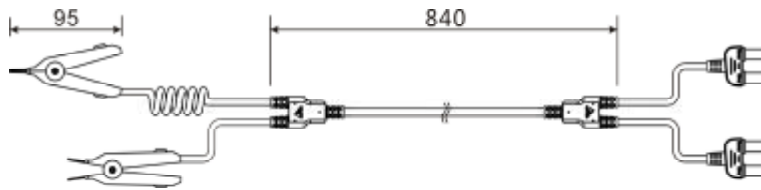

#### Expansion length

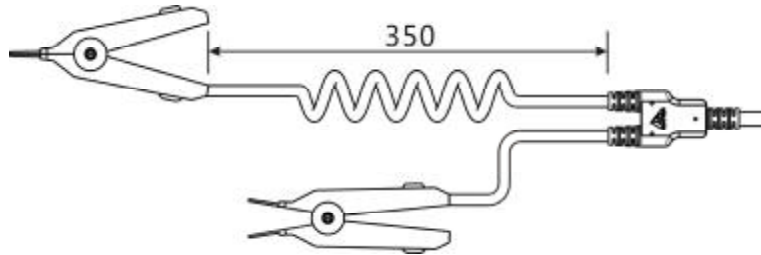

### 9363-B test clip

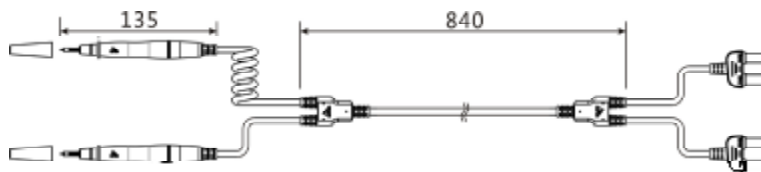

#### Expansion length

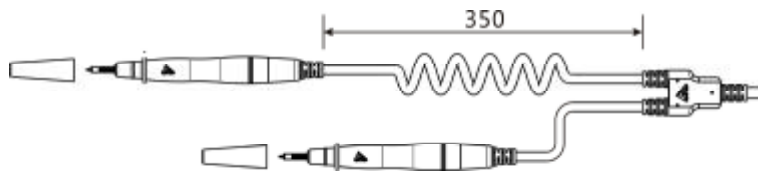

Test probe needle size:

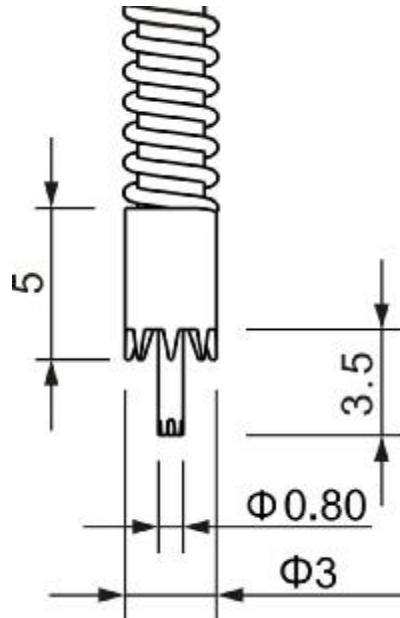

9365 Zero plate

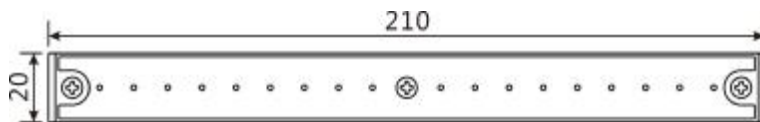

Test pin reset

