

SDS3000X HD Series Digital Oscilloscope

User Manual

EN01A



Contents

| | | |
|----------|---|-----------|
| 1 | Introduction | 1 |
| 2 | Important Safety Information | 2 |
| 2.1 | General Safety Summary | 2 |
| 2.2 | Safety Terms and Symbols..... | 4 |
| 2.3 | Working Environment | 5 |
| 2.4 | Cooling Requirements..... | 6 |
| 2.5 | Power and Grounding Requirements..... | 6 |
| 2.6 | Cleaning..... | 7 |
| 2.7 | Abnormal Conditions | 8 |
| 2.8 | Safety Compliance | 8 |
| | Informations essentielles sur la sécurité..... | 9 |
| | Exigence de Sécurité..... | 9 |
| | Termes et symboles de sécurité..... | 11 |
| | Environnement de travail..... | 12 |
| | Exigences de refroidissement | 14 |
| | Connexions d'alimentation et de terre | 14 |
| | Nettoyage..... | 15 |
| | Conditions anormales | 16 |
| | Conformité en matière de sécurité | 16 |
| 3 | First Steps | 17 |
| 3.1 | Delivery Checklist..... | 17 |
| 3.2 | Quality Assurance..... | 17 |
| 3.3 | Maintenance Agreement | 17 |
| 4 | Document Conventions | 18 |
| 5 | Getting Started | 19 |
| 5.1 | Mechanical Dimensions | 19 |
| 5.2 | Adjust the Supporting Legs | 20 |
| 5.3 | Power on | 20 |
| 5.4 | Shut down..... | 21 |
| 5.5 | System Information | 21 |
| 5.6 | Install Options..... | 21 |
| 6 | Quick Start..... | 22 |
| 6.1 | Front Panel Overview | 22 |
| 6.2 | Rear Panel Overview | 23 |
| 6.3 | Connecting to External Devices/Systems | 24 |

| | | |
|-----------|--|-----------|
| 6.3.1 | Power Supply | 24 |
| 6.3.2 | LAN | 24 |
| 6.3.3 | USB Peripherals..... | 24 |
| 6.3.4 | Auxiliary Output..... | 24 |
| 6.3.5 | Waveform Generator..... | 24 |
| 6.3.6 | Probes | 25 |
| 6.3.7 | Logic Probe | 26 |
| 7 | Remote Control | 27 |
| 7.1 | Web Browser | 27 |
| 7.2 | Other Connectivity | 28 |
| 8 | Touch Screen Display | 29 |
| 8.1 | Overview | 29 |
| 8.2 | Menu Bar | 30 |
| 8.3 | Grid Area | 31 |
| 8.4 | Channel Descriptor Box | 32 |
| 8.5 | Timebase and Trigger Descriptor Boxes..... | 34 |
| 8.6 | Dialog Box | 36 |
| 8.7 | Touch Gestures | 38 |
| 8.8 | Mouse and Keyboard Operation | 39 |
| 8.9 | Choosing the Language | 39 |
| 9 | Front Panel | 40 |
| 9.1 | Overview..... | 40 |
| 9.2 | Vertical Control | 41 |
| 9.3 | Horizontal Control..... | 42 |
| 9.4 | Trigger Control..... | 42 |
| 9.5 | <input type="button" value="Run/Stop"/> Button | 43 |
| 9.6 | <input type="button" value="Auto Setup"/> Button | 43 |
| 9.7 | Cursors Control | 43 |
| 9.8 | Universal Knob | 43 |
| 9.9 | Other Buttons | 44 |
| 10 | Multiple Approaches to Recall Functions | 45 |
| 10.1 | Menu Bar | 45 |
| 10.2 | Descriptor Box | 45 |
| 10.3 | Shortcut Button on the Front panel | 46 |
| 11 | Quickly Capture the Signal..... | 47 |
| 12 | Vertical Setup | 48 |

| | | |
|-----------|--|-----------|
| 12.1 | Turn on/off a Channel..... | 48 |
| 12.2 | Channel Setup..... | 49 |
| 13 | Digital Channels..... | 54 |
| 13.1 | Overview..... | 54 |
| 13.2 | Enable/Disable the Digital Channels..... | 56 |
| 13.3 | Digital Channel Setup..... | 57 |
| 14 | Horizontal and Acquisition Setup..... | 61 |
| 14.1 | Timebase Setup..... | 61 |
| 14.2 | Acquisition Setup..... | 62 |
| 14.2.1 | Overview..... | 62 |
| 14.2.2 | Acquisition..... | 64 |
| 14.2.3 | Memory Management..... | 66 |
| 14.2.4 | Roll Mode..... | 67 |
| 14.2.5 | Sequence..... | 67 |
| 14.3 | History..... | 70 |
| 15 | Zoom..... | 73 |
| 16 | Trigger..... | 76 |
| 16.1 | Overview..... | 76 |
| 16.2 | Trigger Setup..... | 77 |
| 16.3 | Trigger Level..... | 78 |
| 16.4 | Trigger Mode..... | 79 |
| 16.5 | Trigger Type..... | 80 |
| 16.5.1 | Overview..... | 80 |
| 16.5.2 | Edge Trigger..... | 81 |
| 16.5.3 | Slope Trigger..... | 81 |
| 16.5.4 | Pulse Trigger..... | 83 |
| 16.5.5 | Video Trigger..... | 84 |
| 16.5.6 | Window Trigger..... | 87 |
| 16.5.7 | Interval Trigger..... | 88 |
| 16.5.8 | Dropout Trigger..... | 89 |
| 16.5.9 | Runt Trigger..... | 90 |
| 16.5.10 | Pattern Trigger..... | 90 |
| 16.5.11 | Qualified Trigger..... | 92 |
| 16.5.12 | Nth Edge Trigger..... | 93 |
| 16.5.13 | Delay Trigger..... | 93 |
| 16.5.14 | Setup/Hold Trigger..... | 94 |
| 16.5.15 | Serial Trigger..... | 94 |

| | | |
|-----------|---|------------|
| 16.6 | Trigger Source | 95 |
| 16.7 | Holdoff | 96 |
| 16.8 | Trigger Coupling | 97 |
| 16.9 | Noise Reject | 98 |
| 16.10 | Zone Trigger | 99 |
| 17 | Serial Trigger and Decode | 103 |
| 17.1 | Overview | 103 |
| 17.2 | I2C Trigger and Serial Decode | 105 |
| 17.2.1 | I2C Signal Settings | 105 |
| 17.2.2 | I2C Trigger | 106 |
| 17.2.3 | I2C Serial Decode | 110 |
| 17.3 | SPI Trigger and Serial Decode | 112 |
| 17.3.1 | SPI Signal Settings | 112 |
| 17.3.2 | SPI Trigger | 115 |
| 17.3.3 | SPI Serial Decode | 115 |
| 17.4 | UART Trigger and Serial Decode | 116 |
| 17.4.1 | UART Signal Settings | 116 |
| 17.4.2 | UART Trigger | 117 |
| 17.4.3 | UART Serial Decode | 117 |
| 17.5 | CAN Trigger and Serial Decode | 119 |
| 17.5.1 | CAN Signal Settings | 119 |
| 17.5.2 | CAN Trigger | 119 |
| 17.5.3 | CAN Serial Decode | 120 |
| 17.6 | LIN Trigger and Serial Decode | 121 |
| 17.6.1 | LIN Signal Settings | 121 |
| 17.6.2 | LIN Trigger | 121 |
| 17.6.3 | LIN Serial Decode | 122 |
| 17.7 | FlexRay Trigger and Serial Decode | 123 |
| 17.7.1 | FlexRay Signal Settings | 123 |
| 17.7.2 | FlexRay Trigger | 123 |
| 17.7.3 | FlexRay Serial Decode | 124 |
| 17.8 | CAN FD Trigger and Serial Decode | 125 |
| 17.8.1 | CAN FD Signal Settings | 125 |
| 17.8.2 | CAN FD Trigger | 125 |
| 17.8.3 | CAN FD Serial Decode | 126 |
| 17.9 | I2S Trigger and Serial Decode | 127 |
| 17.9.1 | I2S Signal Settings | 127 |
| 17.9.2 | I2S Trigger | 128 |

| | | |
|-----------|---|------------|
| 17.9.3 | I2S Serial Decode | 129 |
| 17.10 | MIL-STD-1553B Trigger and Serial Decode | 130 |
| 17.10.1 | MIL-STD-1553B Signal Settings | 130 |
| 17.10.2 | MIL-STD-1553B Serial Trigger | 130 |
| 17.10.3 | MIL-STD-1553B Serial Decode | 132 |
| 17.11 | SENT Trigger and Serial Decode | 133 |
| 17.11.1 | SENT Signal Settings | 133 |
| 17.11.2 | SENT Trigger | 133 |
| 17.11.3 | SENT Serial Decode | 136 |
| 17.12 | Manchester Serial Decode | 139 |
| 17.12.1 | Manchester Signal Settings | 139 |
| 17.12.2 | Manchester Serial Decode | 140 |
| 17.13 | ARINC 429 Trigger and Serial Decode | 141 |
| 17.13.1 | ARINC 429 Signal Settings | 141 |
| 17.13.2 | ARINC 429 Trigger | 141 |
| 17.13.3 | ARINC 429 Serial Decode | 142 |
| 18 | Cursors | 144 |
| 18.1 | Overview | 144 |
| 18.2 | Select and Move Cursors | 150 |
| 19 | Measurement | 152 |
| 19.1 | Overview | 152 |
| 19.2 | Set Parameters | 154 |
| 19.3 | Type of Measurement | 157 |
| 19.3.1 | Vertical Measurement | 157 |
| 19.3.2 | Horizontal Measurement | 159 |
| 19.3.3 | Miscellaneous Measurements | 160 |
| 19.3.4 | Delay Measurement | 161 |
| 19.4 | Trend | 162 |
| 19.5 | Track | 163 |
| 19.6 | Display Mode | 163 |
| 19.7 | Measurement Statistics | 165 |
| 19.8 | Statistics Histogram | 166 |
| 19.9 | Simple Measurements | 167 |
| 19.10 | Gate | 167 |
| 19.11 | Amplitude Strategy | 167 |
| 19.12 | Threshold | 168 |
| 19.13 | Hardware Frequency Counter | 169 |

| | | |
|-----------|--|------------|
| 20 | Math | 170 |
| 20.1 | Overview..... | 170 |
| 20.2 | Arithmetic..... | 172 |
| 20.2.1 | Addition / Subtraction / Multiplication / Division | 172 |
| 20.2.2 | Identity / Negation | 172 |
| 20.2.3 | Average / ERES | 173 |
| 20.2.4 | Max-hold / Min-hold | 173 |
| 20.3 | Algebra | 174 |
| 20.3.1 | Differential | 174 |
| 20.3.2 | Integral | 174 |
| 20.3.3 | Square Root..... | 175 |
| 20.3.4 | Absolute | 176 |
| 20.3.5 | Sign | 176 |
| 20.3.6 | exp/exp10..... | 177 |
| 20.3.7 | ln/lg..... | 177 |
| 20.3.8 | Interpolate | 178 |
| 20.4 | Filter..... | 179 |
| 20.5 | Frequency Analysis | 181 |
| 20.6 | Formula Editor | 189 |
| 21 | Memory | 190 |
| 22 | Analysis Gate | 192 |
| 22.1 | Overview..... | 192 |
| 22.2 | Gate Setup | 194 |
| 23 | Search | 195 |
| 24 | Navigate | 198 |
| 25 | Mask Test | 203 |
| 25.1 | Overview..... | 203 |
| 25.2 | Mask Setup..... | 205 |
| 25.2.1 | Create Mask..... | 205 |
| 25.2.2 | Mask Editor | 206 |
| 25.3 | Pass/Fail Rule | 208 |
| 25.4 | Operation..... | 208 |
| 26 | DVM | 209 |
| 26.1 | Overview..... | 209 |
| 26.2 | Mode..... | 210 |
| 26.3 | Diagrams | 211 |
| 27 | Counter | 213 |

| | | |
|-----------|---|------------|
| 27.1 | Overview..... | 213 |
| 27.2 | Mode..... | 214 |
| 28 | Histogram | 216 |
| 28.1 | Overview..... | 216 |
| 28.2 | Region Setting..... | 218 |
| 29 | Power Analysis | 220 |
| 29.1 | Overview..... | 220 |
| 29.2 | Power Quality | 221 |
| 29.3 | Current Harmonics | 223 |
| 29.4 | Inrush Current..... | 225 |
| 29.5 | Switching Loss..... | 226 |
| 29.6 | Slew Rate | 229 |
| 29.7 | Modulation | 230 |
| 29.8 | Output Ripple..... | 230 |
| 29.9 | Turn On/Turn Off | 231 |
| 29.10 | Transient Response | 233 |
| 29.11 | PSRR..... | 234 |
| 29.12 | Power Efficiency | 235 |
| 29.13 | SOA | 235 |
| 30 | Bode Plot | 238 |
| 30.1 | Overview..... | 238 |
| 30.2 | Configuration | 240 |
| 30.2.1 | Connection | 240 |
| 30.2.2 | Sweep | 240 |
| 30.3 | Display..... | 243 |
| 30.4 | Data Analysis..... | 245 |
| 31 | Display | 248 |
| 32 | Arbitrary Waveform Generator | 256 |
| 32.1 | Overview..... | 256 |
| 32.2 | Output..... | 257 |
| 32.3 | Wave Type..... | 257 |
| 32.4 | Other Setting | 258 |
| 32.5 | System..... | 259 |
| 33 | Save/Recall..... | 261 |
| 33.1 | Save Type..... | 261 |
| 33.2 | File Manager..... | 263 |

| | | |
|-----------|----------------------------------|------------|
| 33.3 | Save and Recall Instances..... | 264 |
| 33.4 | Quick Save and Screenshot..... | 267 |
| 34 | Utility | 268 |
| 34.1 | System Information | 268 |
| 34.2 | System Setting | 269 |
| 34.2.1 | Language | 269 |
| 34.2.2 | Screen Saver | 269 |
| 34.2.3 | Beeper..... | 269 |
| 34.2.4 | Touch Screen | 269 |
| 34.2.5 | Auto Power-on | 269 |
| 34.2.6 | Date/Time..... | 269 |
| 34.2.7 | Reference Position Setting | 270 |
| 34.3 | I/O setting | 273 |
| 34.3.1 | LAN | 273 |
| 34.4 | Install Options..... | 273 |
| 34.5 | Maintenance | 275 |
| 34.5.1 | Upgrade | 275 |
| 34.5.2 | Self-Test | 276 |
| 34.5.3 | Self-Calibration..... | 279 |
| 34.5.4 | Developer Options | 279 |
| 34.6 | Service..... | 280 |
| 34.6.1 | LXI | 280 |
| 34.6.2 | SMB Files share..... | 280 |
| 34.6.3 | Web Server | 282 |
| 34.6.4 | Emulation | 282 |
| 34.7 | Save Button | 283 |
| 34.8 | Quick Action..... | 283 |
| 35 | Troubleshooting..... | 284 |

1 Introduction

A digital oscilloscope is a multi-functional instrument for displaying, analyzing, and storing electrical signals. It is an indispensable tool for designing, manufacturing, and maintaining electronic equipment. This user manual includes important safety and installation information related to the SDS3000X HD series of oscilloscopes and includes simple tutorials for the basic operation of the instrument.

The series includes the following models:

| Model | Analogy Bandwidth | Maximum Sampling Rate | Analog Channel |
|--------------|--------------------------|------------------------------|-----------------------|
| SDS3104X HD | 1 GHz | 4 GSa/s @ each channel | 4 |
| SDS3054X HD | 500 MHz | 4 GSa/s @ each channel | 4 |
| SDS3034X HD | 350 MHz | 4 GSa/s @ each channel | 4 |

2 Important Safety Information

This manual contains information and warnings that must be followed by the user for safe operation and to keep the product in a safe condition.

2.1 General Safety Summary

Carefully read the following safety precautions to avoid personal injury and prevent damage to the instrument and any products connected to it. To avoid potential hazards, please use the instrument as specified.

To Avoid Fire or Personal Injury.

Use Proper Power Line.

Only use a local/state-approved power cord for connecting the instrument to mains power sources.

Ground the Instrument.

The instrument grounds through the protective terra conductor of the power line. To avoid electric shock, the ground conductor must be connected to the earth. Make sure the instrument is grounded correctly before connecting its input or output terminals.

Connect the Signal Wire Correctly.

The potential of the signal wire is equal to the earth, so do not connect the signal wire to a high voltage. Do not touch the exposed contacts or components.

Look over All Terminals' Ratings.

To avoid fire or electric shock, please look over all ratings and signed instructions of the instrument. Before connecting the instrument, please read the manual carefully to gain more information about the ratings.

Equipment Maintenance and Service.

When the equipment fails, please do not dismantle the machine for maintenance. The equipment contains capacitors, power supply, transformers, and other energy storage devices, which may cause high voltage damage. The internal devices of the equipment are sensitive to static electricity, and direct contact can easily cause irreparable damage to the equipment. It is necessary to return to the factory or the company's designated maintenance organization for maintenance. Be sure to pull out the power supply when repairing the equipment. Live line operation is strictly prohibited. The equipment can only be powered on when the maintenance is completed and the maintenance is confirmed to be successful.

Identification of Normal State of Equipment.

After the equipment is started, there will be no alarm information and error information at the interface under normal conditions. The curve of the interface will scan from left to right freely; if there is a pop-up window or button during the scanning process or there is an alarm or error prompt, the device may be in an abnormal state. You need to view the specific prompt information. You can try to restart the instrument to see if it corrects the error condition. If the fault information is still in place, do not use the instrument for testing. Contact the manufacturer or the maintenance department designated by the manufacturer to carry out maintenance before reusing the product.

Not Operate with Suspected Failures.

If you suspect that there is damage to the instrument, please let qualified service personnel check it.

Avoid Circuit or Wire Exposed Components Exposed.

Do not touch exposed contacts or components when the power is on.

Do not operate in wet/damp conditions.**Do not operate in an explosive atmosphere.****Keep the surface of the instrument clean and dry.**

Only probe assemblies that meet the requirement of UL61010-031 and CAN/CSA-C22.2 No.61010-031 shall be used.

Only a lithium battery with the same specifications as the original battery should be used to replace the battery on board.







Do not use the equipment for measurements on mains circuits. Do not use the equipment for measurements on voltages exceeding the voltage ranges described in the manual. The maximum additional transient voltage cannot exceed 1300 V.

The responsible body or operator should refer to the instruction manual to preserve the protection afforded by the equipment. If the equipment is used in a manner not specified by the manufacturer, the protection provided by the equipment may be impaired.

Any parts of the device and its accessories are not allowed to be changed or replaced, other than authorized by the manufacturer or agent.

2.2 Safety Terms and Symbols

When the following symbols or terms appear on the front or rear panel of the instrument or in this manual, they indicate special care in terms of safety.

| | |
|---|--|
|  | This symbol is used where caution is required. Refer to the accompanying information or documents to protect against personal injury or damage to the instrument. |
|  | This symbol warns of a potential risk of shock hazard. |
|  | This symbol is used to denote the measurement ground connection. |
|  | This symbol is used to denote a safety ground connection. |
|  | This symbol shows that the switch is an On/Standby switch. When it is pressed, the scope's state switches between Operation and Standby. This switch does not disconnect the device's power supply. To completely power off the scope, the power cord must be unplugged from the AC socket after the oscilloscope is in the standby state. |
|  | This symbol is used to represent alternating current, or "AC". |
| CAUTION | The "CAUTION" symbol indicates a potential hazard. It calls attention to a procedure, practice, or condition which may be dangerous if not followed. Do not proceed until its conditions are fully understood and met. |
| WARNING | The "WARNING" symbol indicates a potential hazard. It calls attention to a procedure, practice, or condition that, if not followed, could cause bodily injury or death. If a WARNING is indicated, do not proceed until the safety conditions are fully understood and met. |

2.3 Working Environment

The design of the instrument has been verified to conform to EN 61010-1 safety standard per the following limits:

Environment

The instrument is used indoors and should be operated in a clean and dry environment with an ambient temperature range.

Note: Direct sunlight, electric heaters, and other heat sources should be considered when evaluating the ambient temperature.



Warning: Do not operate the instrument in explosive, dusty, or humid environments.

Ambient Temperature

Operating: 0 °C to +50 °C

Non-operation: -30 °C to +70 °C

Note: Direct sunlight, radiators, and other heat sources should be taken into account when assessing the ambient temperature.

Humidity

Operating: 5% ~ 90 %RH, 30 °C, derate to 50 %RH at 50 °C

Non-operating: 5% ~ 95% RH

Altitude

Operating: ≤3,000 m, 25 °C

Non-operating: ≤15,000m

Installation (overvoltage) Category

This product is powered by mains conforming to installation (overvoltage) Category II.

Note: Installation (overvoltage) category I refers to situations where equipment measurement terminals are connected to the source circuit. In these terminals, precautions are done to limit the transient voltage to a correspondingly low level.

Installation (overvoltage) category II refers to the local power distribution level which applies to equipment connected to the AC line (AC power).

Degree of Pollution

The oscilloscopes may be operated in environments of Pollution Degree II.

Note: Degree of Pollution II refers to a working environment that is dry and non-conductive pollution occurs. Occasional temporary conductivity caused by condensation is expected.

IP Rating

IP20 (as defined in IEC 60529).

2.4 Cooling Requirements

This instrument relies on forced air cooling with internal fans and ventilation openings. Care must be taken to avoid restricting the airflow around the apertures (fan holes) on each side of the scope. To ensure adequate ventilation it is required to leave a 15 cm (6 inch) minimum gap around the sides of the instrument.



CAUTION: Do not block the ventilation holes located on both sides of the scope.



CAUTION: Do not allow any foreign matter to enter the scope through the ventilation holes, etc.

2.5 Power and Grounding Requirements

The instrument operates with a single-phase, 100 to 240 Vrms (+/-10%) AC power at 50/60 Hz (+/-5%).

No manual voltage selection is required because the instrument automatically adapts to line voltage. Depending on the type and number of options and accessories (probes, PC port plug-in, etc.), the instrument can consume up to 120 W of power.

Note: The instrument automatically adapts to the AC line input within the following ranges:

| | |
|------------------|---------------|
| Voltage Range: | 90 - 264 Vrms |
| Frequency Range: | 47 - 63 Hz |

The instrument includes a grounded cord set containing a molded three-terminal polarized plug and a standard IEC320 (Type C13) connector for making line voltage and safety ground connections. The AC inlet ground terminal is connected directly to the frame of the instrument. For adequate protection against electrical shock hazards, the power cord plug must be inserted into a mating AC outlet containing a safety ground contact. Use only the power cord specified for this instrument and certified for the country of use.

| | |
|---|--|
|  | <p>Warning: Electrical Shock Hazard!</p> <p>Any interruption of the protective conductor inside or outside of the scope, or disconnection of the safety ground terminal creates a hazardous situation.</p> <p>Intentional interruption is prohibited.</p> |
|---|--|

The position of the oscilloscope should allow easy access to the socket. To make the oscilloscope completely power off, unplug the instrument power cord from the AC socket.

The power cord should be unplugged from the AC outlet if the scope is not to be used for an extended period.

| | |
|---|--|
|  | <p>CAUTION: The outer shells of the front panel terminals (C1, C2, C3, C4, EXT) are connected to the instrument's chassis and therefore to the safety ground.</p> |
|---|--|

2.6 Cleaning

Clean only the exterior of the instrument, using a damp, soft cloth. Do not use chemicals or abrasive elements. Under no circumstances allow moisture to penetrate the instrument. To avoid electrical shock, unplug the power cord from the AC outlet before cleaning.

| | |
|---|--|
|  | <p>Warning: Electrical Shock Hazard!</p> <p>No operator serviceable parts inside. Do not remove covers.</p> <p>Refer servicing to qualified personnel</p> |
|---|--|

2.7 Abnormal Conditions

Do not operate the scope if there is any visible sign of damage or has been subjected to severe transport stresses.

If you suspect the scope's protection has been impaired, disconnect the power cord and secure the instrument against any unintended operation.

Proper use of the instrument depends on the careful reading of all instructions and labels.

| | |
|---|--|
|  | Warning: Any use of the scope in a manner not specified by the manufacturer may impair the instrument's safety protection. This instrument should not be directly connected to human subjects or used for patient monitoring. |
|---|--|

2.8 Safety Compliance

This section lists the safety standards with which the product complies.

U.S. nationally recognized testing laboratory listing

- UL 61010-1:2012/R: 2018-11. Safety Requirements for Electrical Equipment for Measurement, Control, and Laboratory Use – Part 1: General Requirements.
- UL 61010-2-030:2018. Safety Requirements for Electrical Equipment for Measurement, Control, and Laboratory Use – Part2-030: Particular requirements for testing and measuring circuits.

Canadian certification

- CAN/CSA-C22.2 No. 61010-1:2012/A1:2018-11. Safety Requirements for Electrical Equipment for Measurement, Control, and Laboratory Use – Part 1: General Requirements.
- CAN/CSA-C22.2 No. 61010-2-030:2018. Safety Requirements for Electrical Equipment for Measurement, Control, and Laboratory Use – Part 2-030: Particular requirements for testing and measuring circuits.

Informations essentielles sur la sécurité

Ce manuel contient des informations et des avertissements que les utilisateurs doivent suivre pour assurer la sécurité des opérations et maintenir les produits en sécurité.

Exigence de Sécurité

Lisez attentivement les précautions de sécurité ci - après afin d'éviter les dommages corporels et de prévenir les dommages aux instruments et aux produits associés. Pour éviter les risques potentiels, utilisez les instruments prescrits.

Éviter l'incendie ou les lésions corporelles.

Utilisez un cordon d'alimentation approprié.

N'utilisez que des cordons d'alimentation spécifiques aux instruments approuvés par les autorités locales.

Mettez l'instrument au sol.

L'instrument est mis à la Terre par un conducteur de mise à la terre de protection du cordon d'alimentation. Pour éviter un choc électrique, le conducteur de mise à la terre doit être mis à la terre. Assurez - vous que l'instrument est correctement mis à la terre avant de connecter les bornes d'entrée ou de sortie de l'instrument.

Connectez correctement le fil de signalisation.

Le potentiel de la ligne de signal est égal au potentiel au sol, donc ne connectez pas la ligne de signal à haute tension. Ne touchez pas les contacts ou les composants exposés.

Voir les cotes de tous les terminaux.

Pour éviter un incendie ou un choc électrique, vérifiez toutes les cotes et signez les instructions de l'instrument. Avant de brancher l'instrument, lisez attentivement ce manuel pour obtenir de plus amples renseignements sur les cotes.

Entretien du matériel.

En cas de défaillance de l'équipement, ne pas démonter et entretenir l'équipement sans autorisation. L'équipement contient des condensateurs, de l'alimentation électrique, des transformateurs et d'autres dispositifs de stockage d'énergie, ce qui peut causer des blessures à haute tension. Les dispositifs internes de l'équipement sont sensibles à l'électricité statique. Le contact direct peut facilement causer des blessures irréversibles à l'équipement. L'équipement doit être retourné à l'usine ou à l'organisme de maintenance désigné par l'entreprise pour l'entretien. L'alimentation

électrique doit être retirée pendant l'entretien. La ligne ne doit pas être mise sous tension tant que l'entretien de l'équipement n'est pas terminé et que l'entretien n'est pas confirmé.

Identification de l'état normal de l'équipement.

Après le démarrage de l'équipement, dans des conditions normales, il n'y aura pas d'information d'alarme et d'erreur au bas de l'interface, et la courbe de l'interface sera balayée librement de gauche à droite; si un blocage se produit pendant le processus de numérisation, ou si l'information d'alarme ou d'erreur apparaît au bas de l'interface, l'équipement peut être dans un état anormal. Pour voir l'information d'alarme spécifique, vous pouvez d'abord essayer de redémarrer. Si l'information sur la défaillance est toujours présente, ne l'utilisez pas pour l'essai. Contactez le fabricant ou le Service de réparation désigné par le fabricant pour effectuer l'entretien afin d'éviter d'apporter des données d'essai erronées ou de mettre en danger la sécurité personnelle en raison de l'utilisation de la défaillance.

Ne pas fonctionner en cas de suspicion de défaillance.

Si vous soupçonnez des dommages à l'instrument, demandez à un technicien qualifié de vérifier.

L'exposition du circuit ou de l'élément d'exposition du fil est évitée.

Lorsque l'alimentation est connectée, aucun contact ou élément nu n'est mis en contact.

Ne pas fonctionner dans des conditions humides / humides.

Pas dans un environnement explosif.

Maintenez la surface de l'instrument propre et sec.

Le Circuit d'alimentation électrique ne peut pas être mesuré à l'aide du dispositif, ni la tension qui dépasse la plage de tension décrite dans le présent manuel.

Seuls les ensembles de sondes conformes aux spécifications du fabricant peuvent être utilisés.







L'organisme ou l'opérateur responsable doit se référer au cahier des charges pour protéger la protection offerte par le matériel. La protection offerte par le matériel peut être compromise si celui-ci est utilisé de manière non spécifiée par le fabricant.

Aucune pièce du matériel et de ses annexes ne peut être remplacée ou remplacée sans l'autorisation de son fabricant.

Remplacer la batterie dans l'appareil avec les mêmes spécifications de batterie au lithium.

Termes et symboles de sécurité

Lorsque les symboles ou termes suivants apparaissent sur le panneau avant ou arrière de l'instrument ou dans ce manuel, ils indiquent un soin particulier en termes de sécurité.

| | |
|---|--|
|  | Ce symbole est utilisé lorsque la prudence est requise. Reportez-vous aux informations ou documents joints afin de vous protéger contre les blessures ou les dommages à l'instrument. |
|  | Ce symbole avertit d'un risque potentiel de choc électrique. |
|  | Ce symbole est utilisé pour désigner la connexion de terre de mesure. |
|  | Ce symbole est utilisé pour indiquer une connexion à la terre de sécurité. |
|  | Ce symbole indique que l'interrupteur est un interrupteur marche / veille. Lorsqu'il est enfoncé, l'état de l'oscilloscope bascule entre Fonctionnement et Veille. Ce commutateur ne déconnecte pas l'alimentation de l'appareil. Pour éteindre complètement l'oscilloscope, le cordon d'alimentation doit être débranché de la prise secteur une fois l'oscilloscope en état de veille. |
|  | Ce symbole est utilisé pour représenter un courant alternatif, ou "AC". |
| CAUTION | Le symbole " CAUTION" indique un danger potentiel. Il attire l'attention sur une procédure, une pratique ou une condition qui peut être dangereuse si elle n'est pas suivie. Ne continuez pas tant que ses conditions n'ont pas été entièrement comprises et remplies. |
| WARNING | Le symbole " WARNING" indique un danger potentiel. Il attire l'attention sur une procédure, une pratique ou une condition qui, si elle n'est pas suivie, pourrait entraîner des blessures corporelles ou la mort. Si un AVERTISSEMENT est indiqué, ne continuez pas tant que les conditions de sécurité ne sont pas entièrement comprises et remplies. |

Environnement de travail

La conception de l'instrument a été certifiée conforme à la norme EN 61010-1, sur la base des valeurs limites suivantes:

Environnement

L'instrument doit être utilisé à l'intérieur dans un environnement propre et sec dans la plage de température ambiante.

Note: la lumière directe du soleil, les réchauffeurs électriques et d'autres sources de chaleur doivent être pris en considération lors de l'évaluation de la température ambiante.



Attention: ne pas utiliser l'instrument dans l'air explosif, poussiéreux ou humide.

Température ambiante

En fonctionnement: 0 °C à +50 °C

Hors fonctionnement: -30 °C à +70 °C

Note: pour évaluer la température de l'environnement, il convient de tenir compte des rayonnements solaires directs, des radiateurs thermiques et d'autres sources de chaleur.

Humidité

Fonctionnement: 5% ~ 90% HR, 30 °C, 40 °C réduit à 50% HR
Hors fonctionnement: 5% ~ 95%, 65 °C, 24 heures

Altitude

Fonctionnement: ≤ 3000 m

À l'arrêt: ≤ 15,000 m

Catégorie d'installation (surtension)

Ce produit est alimenté par une alimentation électrique conforme à l'installation (surtension) Catégorie II.

Installation (overvoltage) Category Definitions Définition de catégorie d'installation (surtension)

La catégorie II d'installation (surtension) est un niveau de signal applicable aux terminaux de mesure d'équipement reliés au circuit source. Dans ces bornes, des mesures préventives sont prises pour limiter la tension transitoire à un niveau inférieur correspondant.

La catégorie II d'installation (surtension) désigne le niveau local de distribution d'énergie d'un équipement conçu pour accéder à un circuit alternatif (alimentation alternative).

Degré de pollution

Un oscilloscope peut être utilisé dans un environnement Pollution Degree II.

Note: Pollution Degree II signifie que le milieu de travail est sec et qu'il y a une pollution non conductrice. Parfois, la condensation produit une conductivité temporaire.

IP Rating

IP20 (as defined in IEC 60529).

Exigences de refroidissement

Cet instrument repose sur un refroidissement à air forcé avec des ventilateurs internes et des ouvertures de ventilation. Des précautions doivent être prises pour éviter de restreindre le flux d'air autour des ouvertures (trous de ventilateur) de chaque côté de la lunette. Pour assurer une ventilation adéquate, il est nécessaire de laisser un espace minimum de 15 cm (6 pouces) sur les côtés de l'instrument.



ATTENTION: Ne bloquez pas les trous de ventilation situés des deux côtés de la lunette.



ATTENTION: Ne laissez aucun corps étranger pénétrer dans la lunette par les trous de ventilation, etc.

Connexions d'alimentation et de terre

L'instrument fonctionne avec une alimentation CA monophasée de 100 à 240 Vrms (+/- 10%) à 50/60 Hz (+/- 5%).

Aucune sélection manuelle de la tension n'est requise car l'instrument s'adapte automatiquement à la tension de ligne.

Selon le type et le nombre d'options et d'accessoires (sondes, plug-in de port PC, etc.), l'instrument peut consommer jusqu'à 120 W d'énergie.

Remarque: l'instrument s'adapte automatiquement à l'entrée de ligne CA dans les plages suivantes:

| | |
|----------------------|---------------|
| Plage de tension: | 90 - 264 Vrms |
| Gamme de fréquences: | 47 - 63 Hz |

L'instrument comprend un jeu de cordons mis à la terre contenant une fiche polarisée à trois bornes moulée et un connecteur standard IEC320 (Type C13) pour établir la tension de ligne et la connexion de mise à la terre de sécurité. La borne de mise à la terre de l'entrée CA est directement connectée au châssis de l'instrument. Pour une protection adéquate contre les risques d'électrocution, la fiche du cordon d'alimentation doit être insérée dans une prise secteur correspondante contenant un contact de sécurité avec la terre. Utilisez uniquement le cordon d'alimentation spécifié pour cet instrument et certifié pour le pays d'utilisation.



Avertissement: risque de choc électrique!

Toute interruption du conducteur de terre de protection à l'intérieur ou à l'extérieur de la portée ou la déconnexion de la borne de terre de sécurité crée une situation dangereuse.

L'interruption intentionnelle est interdite.

La position de l'oscilloscope doit permettre un accès facile à la prise. Pour éteindre complètement l'oscilloscope, débranchez le cordon d'alimentation de l'instrument de la prise secteur.

Le cordon d'alimentation doit être débranché de la prise secteur si la lunette ne doit pas être utilisée pendant une période prolongée.



ATTENTION: les enveloppes extérieures des bornes du panneau avant (C1, C2, C3, C4, EXT) sont connectées au châssis de l'instrument et donc à la terre de sécurité.

Nettoyage

Nettoyez uniquement l'extérieur de l'instrument à l'aide d'un chiffon doux et humide. N'utilisez pas de produits chimiques ou d'éléments abrasifs. Ne laissez en aucun cas l'humidité pénétrer dans l'instrument. Pour éviter les chocs électriques, débranchez le cordon d'alimentation de la prise secteur avant de le nettoyer.



Avertissement: risque de choc électrique!

Aucune pièce réparable par l'opérateur à l'intérieur. Ne retirez pas les capots.

Confiez l'entretien à un personnel qualifié

Conditions anormales

Utilisez l'instrument uniquement aux fins spécifiées par le fabricant.

N'utilisez pas la lunette s'il y a des signes visibles de dommages ou si elle a été soumise à de fortes contraintes de transport.

Si vous pensez que la protection de l'oscilloscope a été altérée, débranchez le cordon d'alimentation et sécurisez l'instrument contre toute opération involontaire.

Une bonne utilisation de l'instrument nécessite la lecture et la compréhension de toutes les instructions et étiquettes.

| | |
|---|--|
|  | <p>Avertissement: Toute utilisation de l'oscilloscope d'une manière non spécifiée par le fabricant peut compromettre la protection de sécurité de l'instrument. Cet instrument ne doit pas être directement connecté à des sujets humains ni utilisé pour la surveillance des patients.</p> |
|---|--|

Conformité en matière de sécurité

La présente section présente les normes de sécurité applicables aux produits.

U.S. nationally recognized testing laboratory listing

- UL 61010-1:2012/R:2018-11. Prescriptions en matière de sécurité pour les appareils électriques utilisés en laboratoire et de mesure - partie 1: prescriptions générales.
- UL 61010-2-030:2018. Prescriptions de sécurité pour les appareils électriques de mesure, de contrôle et de laboratoire - partie 2 - 030: prescriptions spéciales pour les circuits d'essai et de mesure.

Canadian certification

- CAN/CSA-C22.2 No. 61010-1:2012/A1:2018-11. Prescriptions en matière de sécurité pour les appareils électriques utilisés en laboratoire et de mesure - partie 1: prescriptions générales.
- CAN/CSA-C22.2 No. 61010-2-030:2018. Prescriptions de sécurité pour les appareils électriques de mesure, de contrôle et de laboratoire - partie 2 - 030: prescriptions spéciales pour les circuits d'essai et de mesure.

3 First Steps

3.1 Delivery Checklist

First, verify that all items listed on the packing list have been delivered. If you note any omissions or damage, please contact your nearest **SIGLENT** customer service center or distributor as soon as possible. If you fail to contact us immediately in case of omission or damage, we will not be responsible for replacement.

3.2 Quality Assurance

The oscilloscope has a 3-year warranty (1-year warranty for probes and accessories) from the date of shipment, during normal use and operation. **SIGLENT** can repair or replace any product that is returned to the authorized service center during the warranty period. We must first examine the product to make sure that the defect is caused by the process or material, not by abuse, negligence, accident, abnormal conditions, or operation.

SIGLENT shall not be responsible for any defect, damage, or failure caused by any of the following:

- a) Attempted repairs or installations by personnel other than **SIGLENT**.
- b) Connection to incompatible devices/incorrect connection.
- c) For any damage or malfunction caused by the use of non-**SIGLENT** supplies. Furthermore, **SIGLENT** shall not be obligated to service a product that has been modified. Spare, replacement parts, and repairs have a 90-day warranty.

The oscilloscope's firmware has been thoroughly tested and is presumed to be functional. Nevertheless, it is supplied without a warranty of any kind covering detailed performance. Products not made by **SIGLENT** are covered solely by the warranty of the original equipment manufacturer.

3.3 Maintenance Agreement

We provide various services based on maintenance agreements. We offer extended warranties as well as installation, training, enhancement and on-site maintenance, and other services through specialized supplementary support agreements. For details, please consult your local **SIGLENT** customer service center or distributor.

4 Document Conventions

For convenience, text surrounded by a box border is used to represent the button of the front panel. For example, `Default` represents the "Default" button on the front panel. Italicized text with shading is used to represent the touchable or clickable menu/button/region on the touch screen. For example, `Display` represents the "Display" menu on the screen:

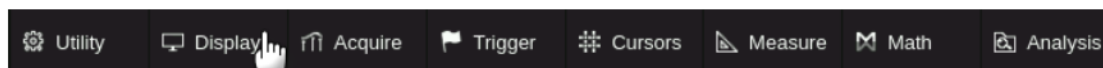

For the operations that contain multiple steps, the description is in the form of "Step 1 > Step 2 >...". As an example, follow each step in the sequence to enter the upgrade interface:

`Utility` > `Menu` > `Maintenance` > `Upgrade`

Click the `Utility` > `Menu` in the menu bar as step 1, click the `Maintenance` option on the screen as step 2, and click the `Update` option on the screen as step 3 to enter the upgrade interface.

5 Getting Started

5.1 Mechanical Dimensions

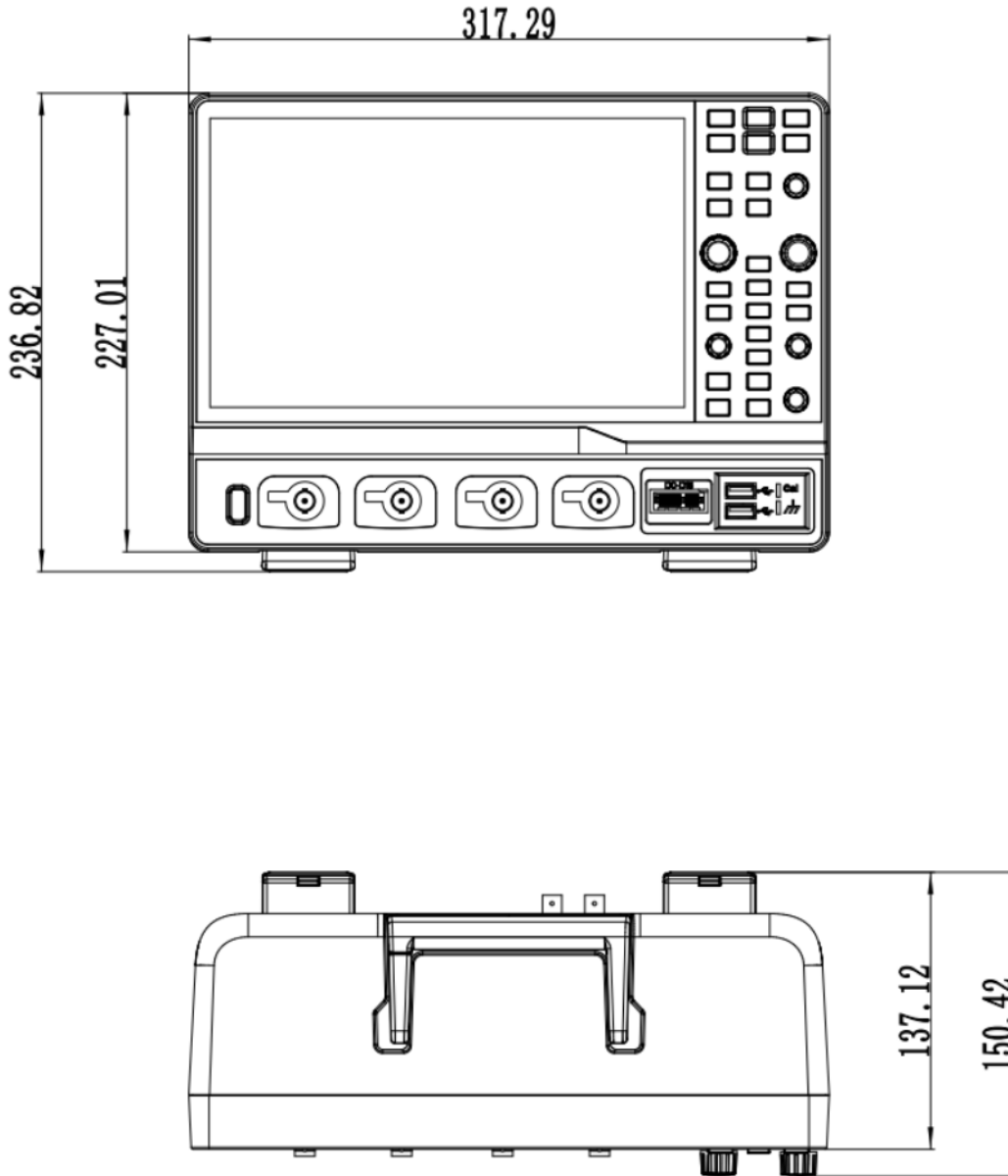

5.2 Adjust the Supporting Legs

Adjust the supporting legs properly to use them as stands to tilt the oscilloscope upwards for stable placement as well as easier operation and observation of the instrument.

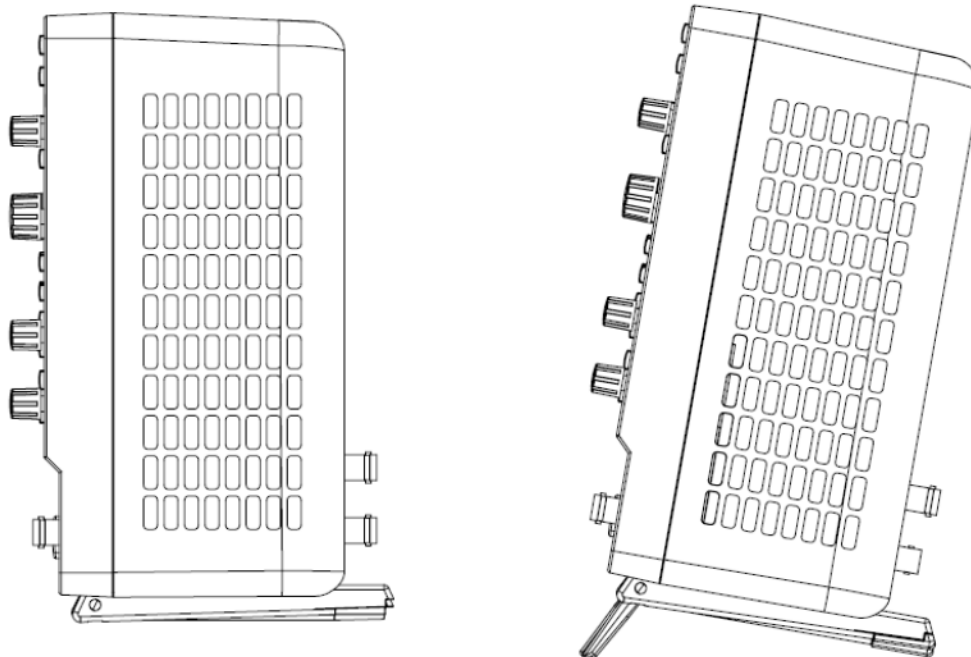

5.3 Power on

SDS3000X HD provides two ways for power on, which are:

Auto Power-on

When the "Auto Power-on" option is enabled, once the oscilloscope is connected to the AC power supply through the power cord, the oscilloscope boots automatically. This is useful in automated or remote applications where physical access to the instrument is difficult or impossible.

Steps for enabling the "Auto Power-on" function:

Utility > **Menu** > **System Setting** > **Auto Power On**

Power on by Manual

When the "Auto Power-on" option is disabled, the power button on the front panel is the only control for the power state of the oscilloscope.

5.4 Shut down

Press the power button to turn off the oscilloscope. Or follow the steps below:

Utility > *Shutdown*

Note: The Power button does not disconnect the oscilloscope from the AC power supply. The only way to fully power down the instrument is to unplug the AC power cord from the outlet. The power cord should be unplugged from the AC outlet if the scope is not to be used for an extended period.

5.5 System Information

Follow the steps below to examine the software and hardware versions of the oscilloscope.

Utility > *Menu* > *System Info*

See the section "System Information" for details.

5.6 Install Options

A license is necessary to unlock a software option. See the section "Install Option" for details.

6 Quick Start

6.1 Front Panel Overview



- A. **Touch Screen Display:** The display and major functions area. See the "Touch Screen Display" chapter for more details
- B. **Front Panel:** Includes knobs and buttons. See the "Front Panel" chapter for more details
- C. **Probe Compensation/ Ground Terminal:** Supplies a 0-3 V, 1 kHz square wave for compensating the probes
- D. **USB 3.0 Host Ports:** Connect the USB host ports to USB storage devices for data transfer or a USB mouse/keyboard for control
- E. **Digital Input Connector:** Receives digital signals from the SPL2016 digital probe
- F. **Analog Input Connectors**
- G. **Power Switch**
- H. **Supporting Legs:** Adjust the supporting legs properly to use them as stands to tilt the oscilloscope for stable positioning of the oscilloscope

6.2 Rear Panel Overview



- A. **Ext Trigger Input**
- B. **Auxiliary Out:** Outputs the trigger indicator. When Mask Test is enabled, outputs the pass / fail signal
- C. **1000M LAN Port:** Connect the port to the network for remote control
- D. **USB 3.0 Device Port:** Connect with a PC for remote control
- E. **USB 2.0 Host Port:** connect with a USB storage device or USB mouse/keyboard
- F. **AC Power Input**
- G. **Lockhole**
- H. **Handle**

6.3 Connecting to External Devices/Systems

6.3.1 Power Supply

The standard power supply for the instrument is 100~240 V, 50/60 Hz. Please use the power cord provided with the instrument to connect it to AC power.

6.3.2 LAN

Connect the LAN port to the network with a network cable with an RJ45 connector for remote control. See chapter "Remote Control" for detailed information on controlling the instrument with a computer.

Follow the steps below to set LAN connection:

`Utility` > `Menu` > `I/O` > `LAN Config`

See section "LAN" for details of the configuration.

6.3.3 USB Peripherals

Connect a USB storage device (FAT32 format recommended) to one of the USB host ports for data transfer, or connect a USB mouse/keyboard to one of the USB host ports for controlling the instrument.

See chapter "Save/Recall" for details of data transfer.

6.3.4 Auxiliary Output

When Mast Test is enabled, the port outputs the pass/fail signal, otherwise, it outputs the trigger indicator. The trigger indicator can be used to measure the waveform capture rate.

See the chapter "Mask Test" for more details on the pass/fail output.

6.3.5 Waveform Generator

The SDS3000X HD supports an external function/arbitrary waveform generator module.

You can purchase an external SAG1021I function/arbitrary waveform generator module with isolated output to use as a waveform generator. Connect the SAG1021I to any USB host port of the oscilloscope through a USB cable. To use the SAG1021I, you also need to purchase the "SDS3000HD-FG" software activation option.

Press the **WaveGen** button on the front panel or touch the screen **Utility** > **Wave Gen** to set the waveform. See chapters "Arbitrary Waveform Generator" and "Bode Plot" for more relative information.

6.3.6 Probes

The SDS3000X HD series oscilloscope supports active probes and passive probes. The specifications and probe documents can be obtained at int.siglent.com, www.siglentna.com, or www.siglenteu.com.

Probe Compensation

When a passive probe is used for the first time, you should compensate it to match the input channel of the oscilloscope. Non-compensated or poorly compensated probes may increase measurement inaccuracy or error. The probe compensation procedures are as follows:

1. Connect the coaxial cable interface (BNC connector) of the passive probe to any channel of the oscilloscope.
2. Connect the probe to the "Compensation Signal Output Terminal" (Cal) on the front of the oscilloscope. Connect the ground alligator clip of the probe to the "Ground Terminal" under the compensation signal output terminal.



3. Press the **Auto Setup** button.
4. Check the waveform displayed and compare it with the following.

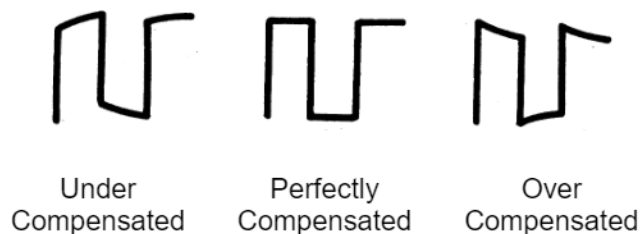

5. Use a non-metallic driver to adjust the low-frequency compensation adjustment hole on the probe until the waveform displayed is as the "Perfectly compensated" in the figure above.

It's not necessary to compensate active probes like the SIGLENT SAP series.

6.3.7 Logic Probe



To connect the logic probe: Insert the probe, with the correct side facing up, until you hear a “click”.

To remove the logic probe: Depress the buttons on each side of the probe, then pull out it.

See chapter “Digital Channels” for more information.

7 Remote Control

The SDS3000X HD provides a LAN port and a USB Device port which can be used for remote control in multiple ways.

7.1 Web Browser

A built-in web server provides an approach to interact with the oscilloscope by a web browser. It doesn't require any additional software to be installed on the computer. Set the LAN port correctly (see section "LAN" for details), input the IP address of the oscilloscope in the browser address bar, and then the user can browse and control the oscilloscope on the web.

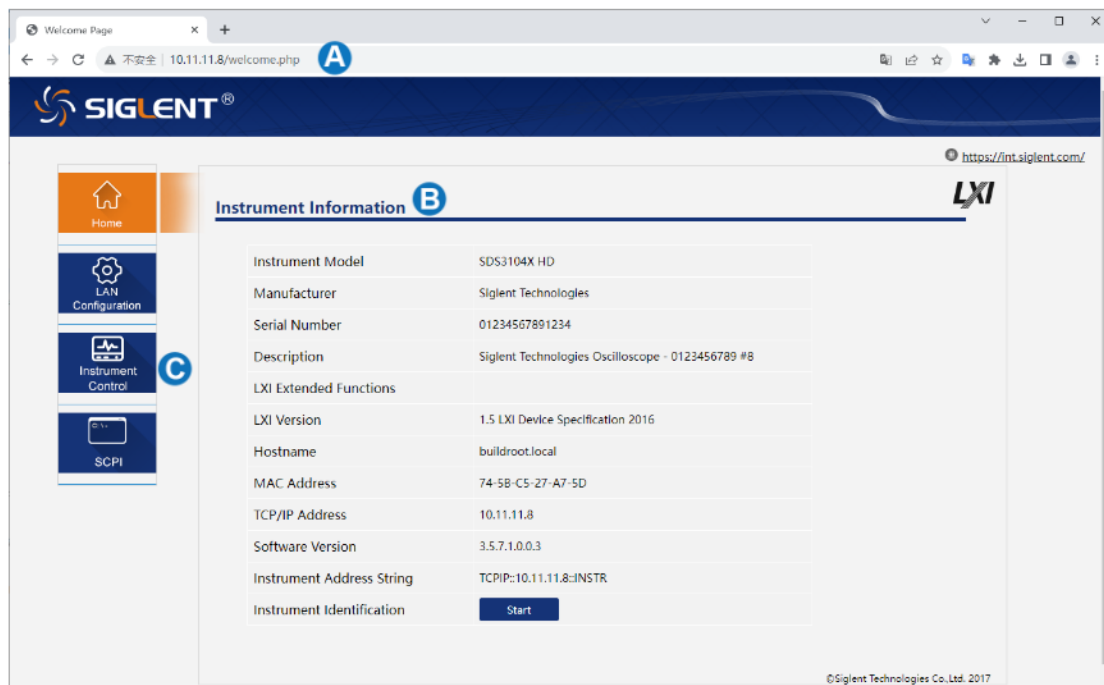

- A. Input the IP address of the instrument
- B. Instrument information
- C. Click here to recall the instrument control interface

Below is the instrument control interface:



- A. Display and control area of the instrument. The display in this area is a copy of the instrument display. Using the mouse to operate in the area is equivalent to directly operating the touch screen display of the instrument.
- B. Click here to perform a screenshot
- C. Click here to save the waveform data as a bin file and download it to the local computer
- D. Click here to save the waveform data as a CSV file and download it to the local computer
- E. Click here to download the mini-tool for converting binary files to CSV
- F. Click here to perform a firmware upgrade

7.2 Other Connectivity

The SDS3000X HD also supports remote control of the instrument by sending SCPI commands via NI-VISA, Telnet, or Socket. For more information, refer to the programming guide for this product.

8 Touch Screen Display

8.1 Overview

The entire SDS3000X HD display is a capacitive touch screen. Use your fingers to touch, drag, pinch, spread, or draw a selection box. Many controls that display information also work as “buttons” to access other functions. If you are using a mouse, you can click anywhere that you can touch to activate a control. You can alternate between clicking and touching the control, whichever is most convenient.

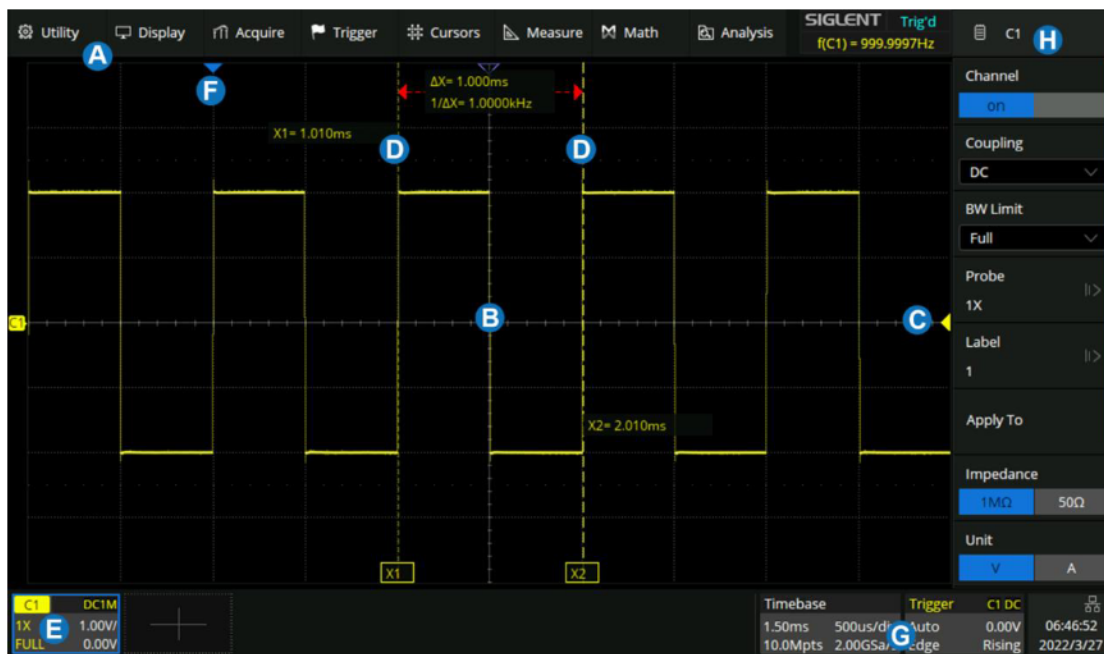

- A. Menu Bar
- B. Grid Area
- C. Trigger Level Indicator
- D. Cursors
- E. Channel Descriptor Boxes
- F. Trigger Delay Indicator
- G. Timebase and Trigger Descriptor Boxes
- H. Dialog Box

Trigger Level Line (Vertical) and **Trigger Delay Indicator** (Horizontal) show the trigger position of the waveform.

Cursors show where measurement points have been set. Move the cursors to quickly reposition the measurement point.

Channel Descriptor boxes include analog channels (Cx), digital channels (D), math (Fx), and memory (Mx). They are located under the grid area, showing the parameters of the corresponding traces. Touching the boxes creates a dialog box.

Timebase and Trigger Descriptor boxes show the parameters of the timebase and trigger respectively. Touching the boxes creates a dialog box for the selected item.

The backlight of the display is adjustable. Follow the steps below to adjust the backlight:

Display > *Menu* > *LCD Brightness*

8.2 Menu Bar

Menu bar with drop-down menus lets you access set-up dialogs and other functions. All functionality can be accessed through the menu bar. It is not necessary for common operations. You can enter most menus by using the front panel or parameter description labels instead of the menu bar. However, the following operations can only be accessed through the menu bar:

Utility > *Help*

Utility > *Save/Recall*

Utility > *Reboot*

Display

Acquire

Analysis

8.3 Grid Area

The grid area displays the waveform traces. Traces can be moved by dragging and re-scaled by pinch and spread. The area is divided into 8 (vertical) * 10 (horizontal) grids. The best display effect can be obtained by adjusting the waveform intensity and graticule. Follow the steps below to set these parameters:

Display > *Menu* > *Intensity* ,

Display > *Menu* > *Graticule*

There are multiple indicators on the grid:

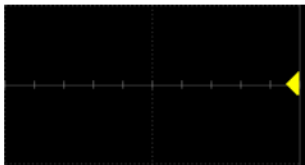

Trigger Level Indicator shows the level where the waveform triggers on the vertical axis.

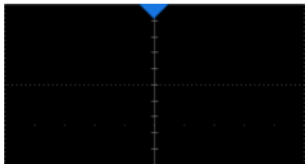

Trigger Delay Indicator locates where the waveform triggers on the horizontal axis... When the trigger position is outside the screen, the direction of the triangle points outside the screen as well.



Channel Offset Indicator with a channel number shows the offset position of the corresponding channel.

The user can choose to show the axis labels or not by:

Display > *Menu* > *Axis label Setting*



Axis label = on



Axis label = off

8.4 Channel Descriptor Box

Channel Descriptor boxes include analog channels (Cx), digital channels (D), math (Fx), and memory (Mx). They are located under the grid area, showing the parameters of the corresponding traces. Touching the boxes creates a dialog box. See chapter “Vertical Setup” for more details. Below is an example for analog channel 1:

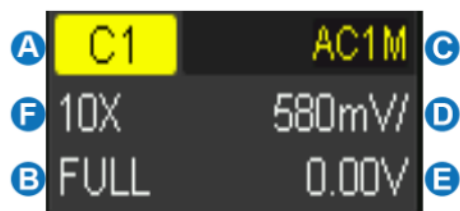

- A. Channel Index
- B. Bandwidth Information
- C. Coupling and Input Impedance
- D. Vertical Scale
- E. Vertical Offset
- F. Probe Attenuation Factor

Bandwidth Information:

The bandwidth information is indicated by the following icons:

20M : 20 MHz bandwidth limit

200M : 200 MHz bandwidth limit

750M : On the 1 GHz model, anti-aliasing filter is automatically turned on when the channel is in non-interleaving mode (i.e. sample rate ≤ 2 GSa/s). The bandwidth of the anti-aliasing filter is around 750 MHz bandwidth

FULL : Full bandwidth

Invert Indicator: shows that the current channel is inverted:

I : Invert has been turned on

None: Invert has been turned off

Coupling and Input Impedance:

DC1M : DC coupling, 1 M Ω impedance

DC50 : DC coupling, 50 Ω impedance

AC1M : AC coupling, 1 M Ω impedance

AC50 : AC coupling, 50 Ω impedance

GND : Ground

Vertical Scale: The scale of each grid in the vertical direction. For example, when the vertical scale is 1.00 V/div, the full scale of the oscilloscope is 1.00 V/div * 8 div=8 V.

Vertical Offset: The offset of the channel in the vertical direction. When the vertical offset is 0, the channel offset indicator is located in the middle of the vertical axis.

Probe Attenuation Factor: Set the probe attenuation factor to match the actual attenuation of the probe. The oscilloscope automatically calculates the vertical scale according to the probe attenuation factor. For example, the vertical scale of the oscilloscope is 100mV/div with 1X attenuation, and 1V/div if the attenuation factor is changed to 10X. When inserting a standard 10X passive probe with a probe sense terminal, the oscilloscope will automatically set the factor to 10X.

 : 1:1 attenuation, suitable for direct coaxial cable connection or passive probes with 1X attenuation.

 : 10:1 attenuation, suitable for general passive probes or active probes with 10X attenuation.

 : 100:1 attenuation, suitable for some high-voltage probes

 : Custom attenuation factor

8.5 Timebase and Trigger Descriptor Boxes

The Timebase Descriptor box shows the parameters of the timebase. See chapter “Horizontal and Acquisition Setup” for more information.

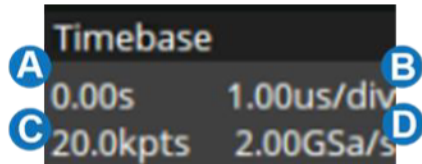

- A. Trigger delay
- B. Horizontal scale (timebase)
- C. # Samples
- D. Sample Rate

Trigger delay: The time offset of trigger position. When trigger delay is 0, the trigger delay indicator is in the center of the horizontal axis of the grid area.

Horizontal scale: Timebase, the time of each grid in the horizontal direction. For example, if the scale is 500us/div, the time of each grid is 500 us, and the full-screen time range of the oscilloscope is 500 us/div * 10 div = 5 ms.

Samples: The number of sample points on the current screen.

Sample Rate: The current sample rate.

The Trigger Descriptor box shows the parameters of the trigger setting. See chapter “Trigger” for detailed information.

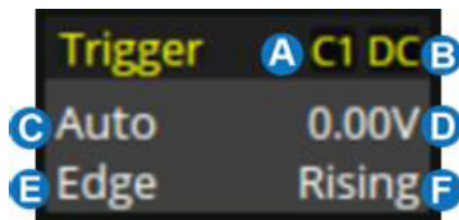

- A. Trigger source
- B. Trigger coupling
- C. Trigger mode
- D. Trigger level
- E. Trigger type
- F. Trigger slope

Trigger source

- C1~C4: Analog channels
- EXT: External trigger channel
- EXT/5: 5x attenuation of external trigger channel
- AC Line: AC mains supply
- D0~D15: Digital channels

Trigger coupling: Coupling mode of the current trigger source. It is only valid when the trigger source is C1~C4, EXT, or EXT/5.

- DC: All the signal's frequency components are coupled to the trigger circuit for high-frequency bursts or where the use of AC coupling would shift the effective trigger level.
- AC: The signal is capacitively coupled. DC levels are rejected. See the datasheet for details of the cut-off frequency.
- HFR: Signals are DC coupled to the trigger circuit, and a low-pass filter network attenuates high frequencies (used for triggering on low frequencies). See the datasheet for details of the cut-off frequency.
- LFR: The signal is coupled through a capacitive high-pass filter network, DC is rejected and low frequencies are attenuated. For stable triggering on medium to high-frequency signals. See the datasheet for details of the cut-off frequency.

Trigger mode

- Auto: The oscilloscope will sweep without a set trigger. An internal timer triggers the sweep after a preset timeout period so that the display refreshes continuously. This is helpful when first analyzing unknown signals. Otherwise, Auto functions the same as Normal when a trigger condition is found.
- Normal: Sweeps only if the input signal meets the trigger condition. Otherwise, it continues to display the last acquired waveform.
- Single: Stops the acquisition and displays the last acquired waveform.

Trigger level: The source voltage level or levels that mark the threshold for the trigger to fire. Trigger levels specified in Volts normally remain unchanged when the vertical gain or offset is modified.

Trigger type: See the chapter "Trigger" for details.

8.6 Dialog Box

The dialog box on the right side of the screen is the main area for setting the parameters of the selected function.

- A. Title bar. Touching the bar can hide the dialog box, and touching again can open the dialog box.
- B. Parameter setting area.
- C. Scroll bar. When parameters are more than the displayed range, the blue scrollbar will be displayed. By sliding the dialog area up and down, or rolling the mouse wheel, it can scroll to the area not displayed.

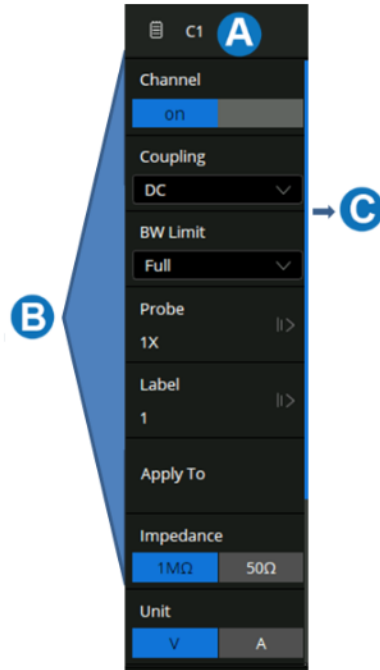

To Set Parameters

The SDS3000X HD provides a couple of different ways to input/select parameters:

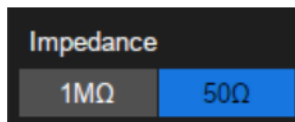

Switch: Sets parameters with two states, such as to enable or disable a function. Touch the switch region to change from one state to the other.

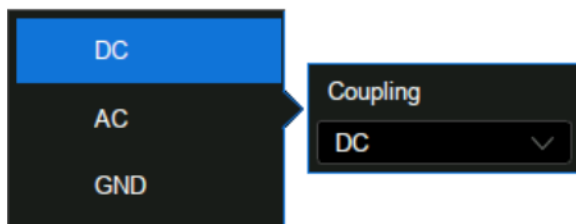

List: Sets parameters with more than two options, such as coupling mode of channels. Touch the parameter region, and then select the expected option from the pop-up list.



Virtual Keypad: Sets parameters with a numerical value. Touch the parameter region, and the parameter can be adjusted by the universal knob on the front panel or by the mouse wheel; touch the region again, then the virtual keypad appears:

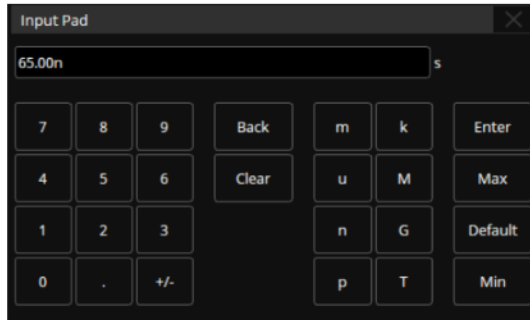

Let's use the operation of setting the "deskew" of a channel as an example: If the expected value is 65 ns, input "65" on the virtual keypad, and then choose the units **n** to complete the operation. On the virtual keypad, touching the button **Max**, **Min**, and **Default** quickly sets the parameter to the maximum, minimum, and default values.

Hide the Dialog Box

When the menu style is set to Embedded, the grid area will be compressed horizontally to display the complete waveform when the dialog box is displayed. After setting the parameters, to achieve the best waveform display effect, touch the title bar in the upper right corner to hide the dialog box. Touch it again to recall the dialog box.

When the menu style is set to Floating, it will directly cover part of the grid area when displayed. If you want to observe the covered area, touch the title bar in the upper right corner to hide the dialog box. Touch it again to recall the dialog box.

The dialog box can be set to be hidden automatically. When the instrument is not operated beyond the set time, the dialog box will be automatically hidden. Follow the steps below:

Display > **Menu** > **Hide Menu**



Menu style = Floating,
and Dialog box is displayed



Dialog box is hidden

8.7 Touch Gestures



Waveforms, cursors, and trigger levels can be adjusted and a rectangular zone can be drawn by touch gestures in the grid area.

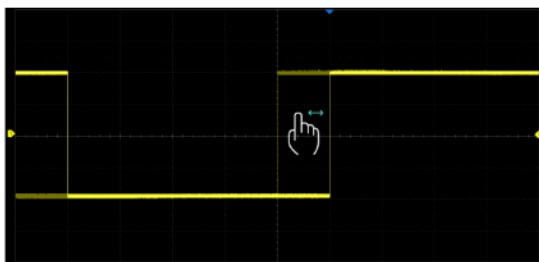

Drag the waveform left and right to move it on the horizontal axis

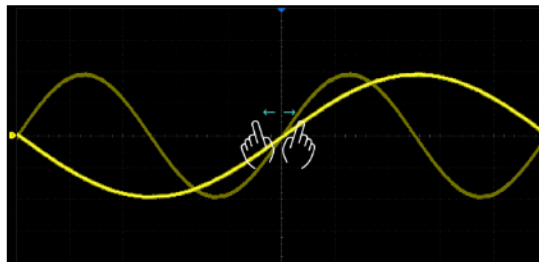

Pinch and spread the waveform horizontally to re-scale the timebase

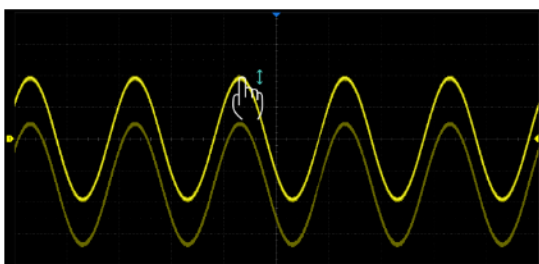

Drag the waveform up and down to move it on the vertical axis

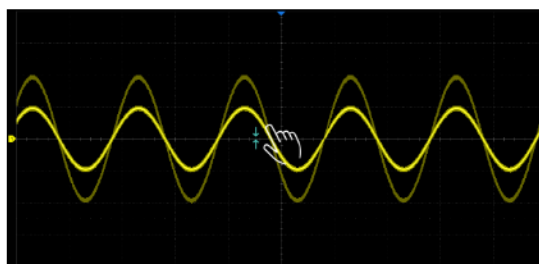

Pinch and spread the waveform vertically to re-scale the vertical gain

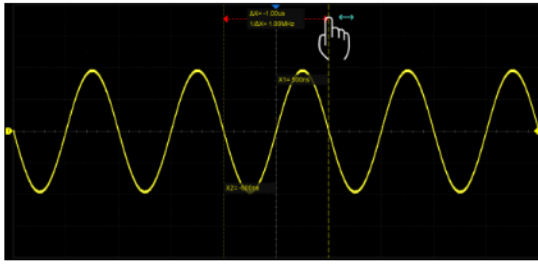

Touch and drag the cursor to move it

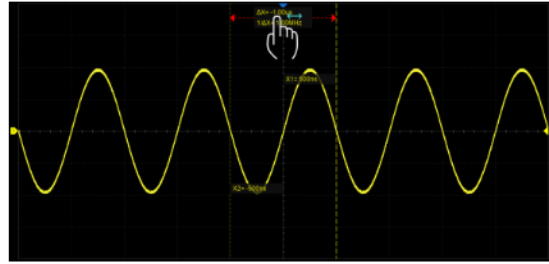

Touch and drag the cursor information region to move the pair of cursors simultaneously

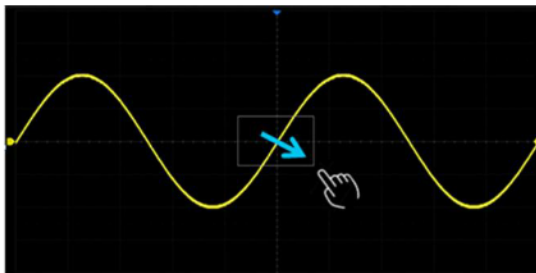

Draw a rectangular box to create a zone or a histogram region. At the beginning of the gesture keep the angle close to 45° so it can be recognized as the drawing box gesture

8.8 Mouse and Keyboard Operation

The SDS3000X HD's user interface features mouse control as well as a touch screen. If the oscilloscope is connected to a USB mouse, you can click on the object with the mouse instead of touching the object. Similarly, if a USB keyboard is connected, you can use the keyboard to input characters instead of using the virtual keyboard.

8.9 Choosing the Language

Follow **Utility** > **Menu** > **System Setting** > **Language** to choose the language. See the section "Language" for details.

9 Front Panel

9.1 Overview



The front panel is designed to operate the basic functions without having to open the software menu. Most of the front panel controls duplicate functionality available through the touch screen display but the operation is more quickly achieved.

All the knobs on the front panel are multi-function. They can be pushed as well as rotated. Pushing a knob quickly recalls a specific function, which is indicated by the silkscreen near the knob.

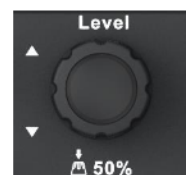

9.2 Vertical Control

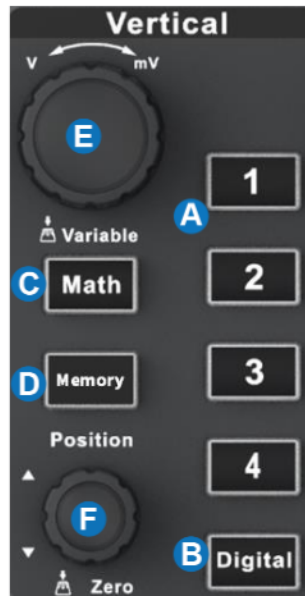

- A. When a channel is disabled, push its channel button to turn it on. When a channel is turned on but not activated, push the button to activate it. When the channel is turned on and activated, push the button to disable it
- B. Press the button to turn on the digital channel and open the **DIGITAL** dialog box. Press again to turn off the digital channels
- C. Press the button to turn on the math function and open the **MATH** dialog box. Press again to turn off the math function
- D. Press the button to turn on the memory waveform function and open the **MEMORY** dialog box. Press again to turn off the memory waveform function
- E. Analog channels (C1-C4), digital channels (D), math (F1-F4), and memory (M1-M4) share the same vertical knob. Rotate the knob to adjust the vertical scale (volts/div) of the activated trace. Push to alternate between coarse and fine adjustments. When the digital channel is active, rotate the knob to change the selected digital channel
- F. Analog channels (C1-C4), digital channels (D), math (F1-F4), and memory (M1-M4) share the same offset knob. Rotate the knob to adjust the DC offset or vertical position of the activated trace. Push to set the offset to zero. When the digital channel is active, rotate the knob to change the position of the selected digital channel

9.3 Horizontal Control

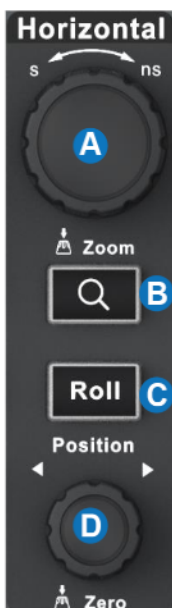

- A. Rotate to adjust the horizontal scale (time/div); push to enable Zoom; push again to switch between the main window and zoom window.
- B. Push to enable Zoom. Push again to exit Zoom mode.
- C. Push to enable horizontal Roll; push again to exit Roll mode. At time-base settings larger than 50 ms/div, it is recommended to set the oscilloscope to Roll mode so that the waveform is displayed in real-time
- D. Rotate to adjust trigger delay; push to set trigger delay to zero

9.4 Trigger Control

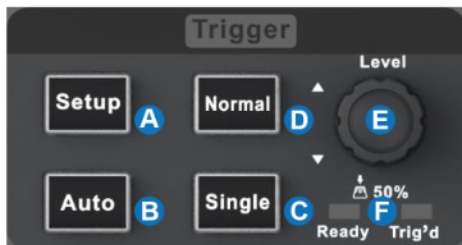

- A. Opens the trigger setup dialog box
- B. Auto mode: Triggers after a preset period if no valid trigger occurs
- C. Single mode: Triggers once when all conditions are met
- D. Normal mode: Triggers repeatedly when all conditions are met
- E. Trigger level adjustment: Push to set the level to 50% of the waveform
- F. Trigger status LED, Ready and Trig'd

9.5 Run/Stop Button



Press the button to switch the acquisition state between Run and Stop. When the state is Run, the button is illuminated in green. When the state is Stop, the button is illuminated in red.

9.6 Auto Setup Button



Auto Setup forces the oscilloscope to automatically set the vertical scale, horizontal scale, and trigger level according to the input signal to get optimum waveform display. An Auto Setup operation can also be performed by following the steps **Acquire** > **Auto Setup**.

9.7 Cursors Control

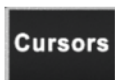



- A. Push the button to open the cursors setup dialog box
- B. Rotate the knob to move the selected cursor; push to select a different cursor

9.8 Universal Knob



When the parameter setting area is highlighted, the Universal Knob can be used to adjust the parameter. Press the knob to select an option from the list. The default function of the Universal Knob is to adjust the intensity of the waveform traces.

9.9 Other Buttons

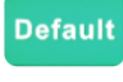
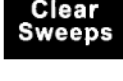
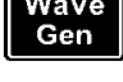
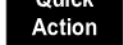
| | |
|---|--|
|  | Enables/Disables measurements and recalls the MEASURE dialog box. |
|  | Performs a quick screenshot save or saves the currently save type file to the storage path. See the section "Save Button" for details. |
|  | Enables/Disables the touch screen. The LED on the button lights to indicate that the touch screen is working. |
|  | Resets the oscilloscope to the default configuration. |
|  | Clears the data or displays in multiple sweeps, including display persistence, measurement statistics, average sweeps, and Pass/Fail statistics. |
|  | Recalls the Wave Gen dialog box. The LED on the button lights to indicate the output of the AWG is enabled. |
|  | The preset functions can be called quickly through this button. See the section "Quick Action" for details |

10 Multiple Approaches to Recall Functions

The oscilloscope can recall functions through different approaches.

10.1 Menu Bar

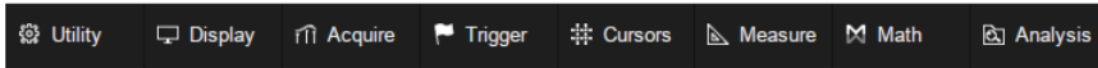

If you are familiar with common computer programs, you may first choose to access a function by the drop-down menu from the menu bar at the top of the display.

For example, to open the trigger setup dialog box, you can follow the steps below:

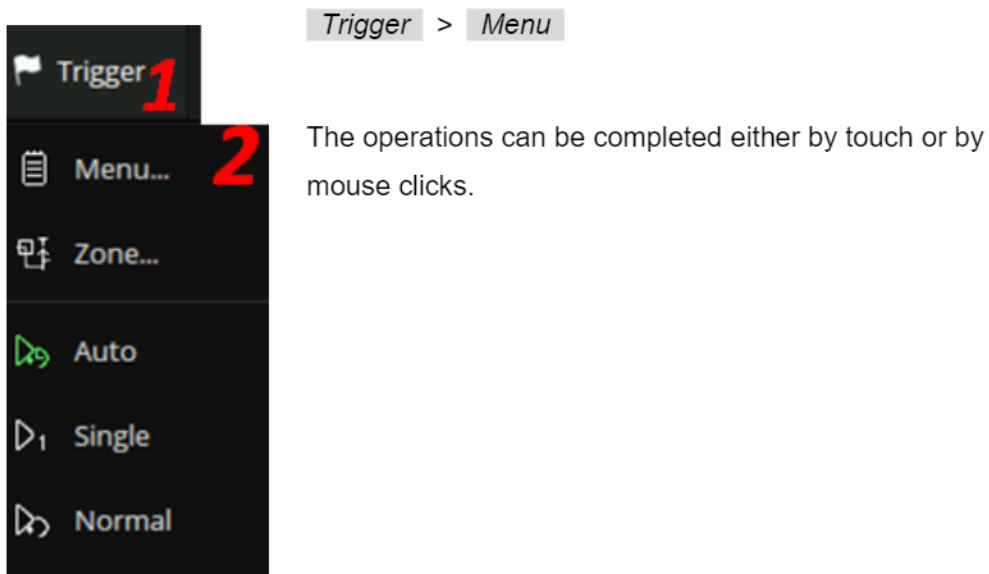

10.2 Descriptor Box

For the setup of channels, math, ref, timebase, and trigger, there are dialog boxes at the bottom of the display. For the introduction of the descriptor box, see sections "Channel Descriptor Box" and "Timebase and Trigger Descriptor Box".

For the example above, touch the trigger descriptor box and the trigger setup dialog box will be activated.

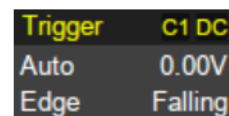

10.3 Shortcut Button on the Front panel

Most of the functions of the oscilloscope can be recalled directly by the shortcut buttons on the front panel. See the chapter "Front Panel" for details.

To open the trigger setup dialog box, press the Setup button in the trigger control area on the front panel.



11 Quickly Capture the Signal

This is an example of how to acquire a signal quickly. In this example, we assume the signal is connected to channel 1 and channel 1 is turned off.

First, press the channel 1 button to turn on channel 1. The LED on the button lights and the descriptor box of channel 1 is displayed at the bottom of the screen.



Second, press the **Auto Setup** button. The oscilloscope will automatically adjust the vertical scale, horizontal scale, and trigger level according to the input signal to get an optimum waveform display.



Auto Setup will not work on all signal types, especially time-varying bursts or slow signals (< 100 Hz). If Auto Setup cannot achieve desired settings, manual adjustment of the vertical, horizontal, and trigger systems is preferred. See the chapters "Vertical Setup", "Horizontal and Acquisition Setup" and "Trigger" for details.

12 Vertical Setup

12.1 Turn on/off a Channel

From the Front Panel

When a channel is disabled, push its channel button to turn it on. When a channel is turned on but not activated, push the button to activate it. When the channel is turned on and activated, push the button to disable it

From the Touch Screen

Touch the **+** button and then select the expected channel to turn it on, and its channel descriptor box and a dialog box will appear on the display. Touch the channel descriptor box and then touch the **Off** button to disable it.

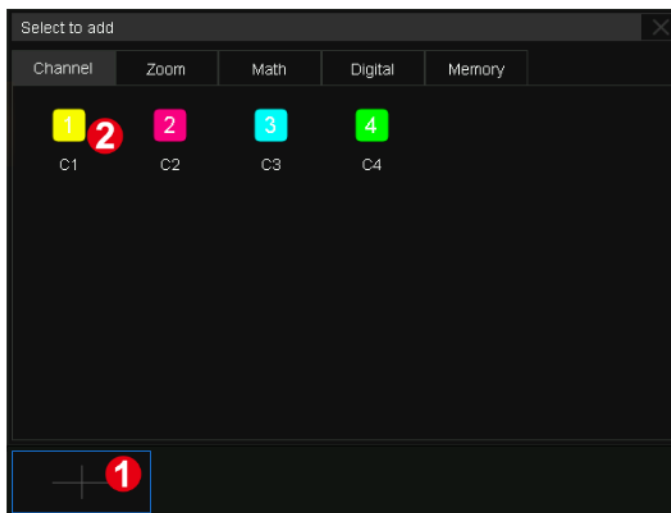

Turn on C1

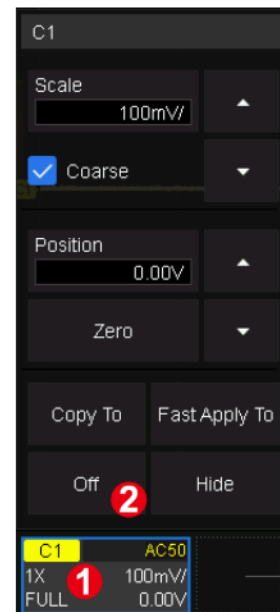

Turn off C1

12.2 Channel Setup

Touch the channel descriptor box, a quick dialog will pop up. Vertical scale and offset can also be set from this dialog box.

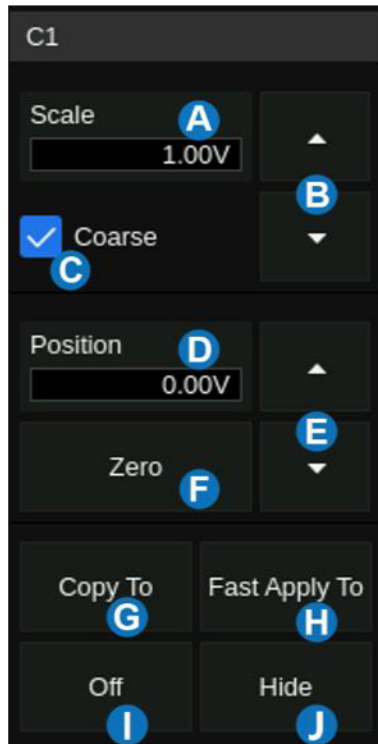

- A. Touch the region to set the vertical scale with the universal knob or virtual keypad
- B. ▲ to increase the vertical scale and ▼ to decrease
- C. Check to coarsely adjust the vertical scale and uncheck to enable fine adjustment
- D. Touch the region to set the offset with the universal knob or virtual keypad
- E. ▲ to increase the offset and ▼ to decrease
- F. Set the offset to zero
- G. Copy the setting of the current channel to another channel
- H. Quickly apply the current channel as the source of a specified operation (Trigger, FFT, Simple Measure, Cursor, Search, DVM, and Counter)
- I. Disable the channel
- J. Hide the trace

The vertical scale can be adjusted in coarse or fine mode. Fine mode can reach the full-scale display as close as possible, which gets the best measurement accuracy in the vertical direction. The oscilloscope automatically switches to fine mode when the vertical scale is controlled by touch gestures.

Activating a channel recalls the channel dialog box, displaying more parameters:

- A. Turn channel on/off
- B. Coupling (DC, AC, or GND)
- C. Bandwidth limit (Full, 200 MHz, or 20 MHz)
- D. Probe settings including attenuation (1X, 10X, 100X, or custom) and probe check.
- E. Set the label text. Click to recall the label setting. Users can customize the text and display of the label
- F. Quickly apply a specified operation (Trigger, FFT, Simple Measure, Cursor, Search, DVM, Histogram, Mask Test, Counter, and AWG) to the current channel
- G. Impedance
- H. Units for the channel
- I. Deskew
- J. Enable/disable invert
- K. Trace visible/hidden

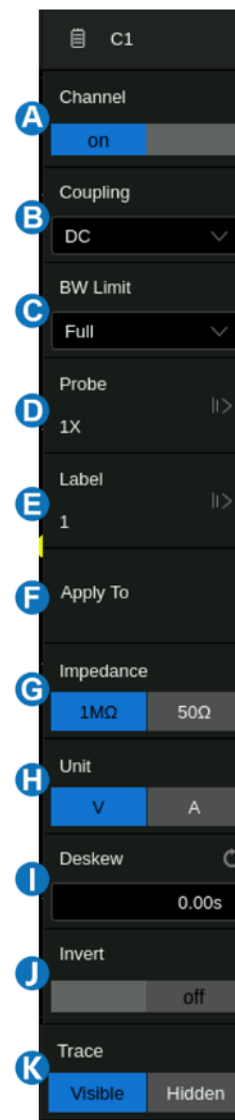

Coupling

- DC: All of the input signal frequency components are passed to the display.
- AC: The signal is capacitively coupled. DC signal components are rejected. See the datasheet for details of the cut-off frequency. AC coupling is suitable for observing AC signals with DC offset, such as power ripple.
- GND: The channel is grounded by an internal switch. GND coupling is used to observe the zero offset error of the analog channels or determine the source of noise in the waveform (from signal or from oscilloscope itself)

Bandwidth Limit

Full bandwidth passes through signals with high-frequency components, but it also means that noise with high-frequency components can pass through. When the frequency component of the signal is very low, better signal-to-noise ratios (SNR) can be obtained by turning on a bandwidth limit. The SDS3000X HD provides two hardware bandwidth limit options: 20 MHz and 200 MHz.

Probe Settings

The SDS3000X HD provides 1X, 10X, 100X, and custom probe attenuation factor options. The custom values can be between 10^{-6} ~ 10^6 . The oscilloscope will automatically convert the vertical scale according to the current probe attenuation factor. For example, the vertical scale of the oscilloscope under 1X attenuation is 100 mV/div, and the vertical scale will be automatically set to 1 V/div if the probe attenuation is changed to 10X. If a standard probe with a readout terminal is connected, the oscilloscope will automatically set the probe attenuation to match the probe.

The Probe Check option is provided to quickly check if the probe is correctly compensated. Connect the probe as in section “Probes” and touch **Probe** > **Probe Check**, then operate according to the prompt.

Label

Users can set the label text for channels. Open the label setting dialog box to select the source, customize the label text, and set the display. The source can be C1~C4, F1~F4, and M1~M4. The length of the label is limited to 20 characters. The characters beyond this length will not be displayed. When the “Display” option is set to “on”, the label will be displayed on the right side of the channel offset indicator.

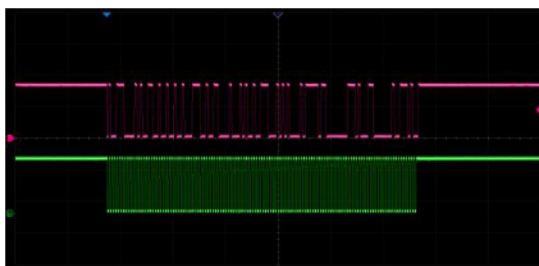

The labels are hidden

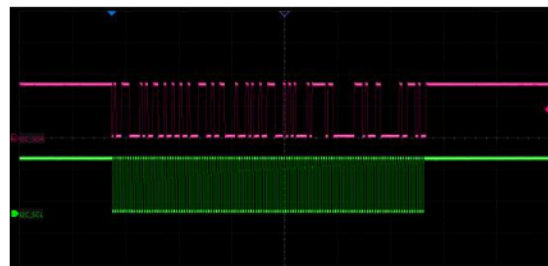

The labels are displayed

Apply to

With this setting, some common functions such as Trigger, FFT, Simple Measure, Cursor, Search, DVM, Histogram, Mask Test, Counter, and AWG can be quickly applied to the selected channel. Once a function is specified, it will switch directly to the function menu and automatically set that channel as the source.

Impedance

- 1 M Ω : When a passive probe with high impedance is connected, the impedance must be set to 1 M Ω , otherwise the signal will not be detected.
- 50 Ω : Suitable for high-frequency signals transmitted through 50 Ω coaxial cables or active probes. This can minimize the amplitude distortion caused by impedance mismatching.

| | |
|---|--|
|  | <p>Warning: The 50 Ω input setting is not a high-power input. Damage can occur if the input exceeds the published specifications. See the datasheet for more details.</p> |
|---|--|

Unit

Voltage unit "V" or current unit "A". When using the current probe, the unit should be set to "A".

Deskew

Due to the skew between channels, cables, or probes, the delay of signals passing through different measurement paths may be inconsistent. For example, two coaxial cables with a 1-inch difference in length could introduce a skew of more than 100 ps. In some scenarios (e.g. measuring the setup/hold time between clock and data), it may be necessary to compensate for the skew between channels.

The method of compensation: Probe the same signal simultaneously using two channels (including the cables or probes that you intend to use for measurements) and adjust the deskew parameter of one channel until the waveforms of the two channels observed on the screen coincide horizontally.



Before deskew



After deskew

Note: When the channel with deskew compensation is the trigger source, the trigger delay indicator does not change as the deskew value changes.

Invert

When invert is enabled, the waveform is rotated 180 degrees around earth potential (0 Volts).

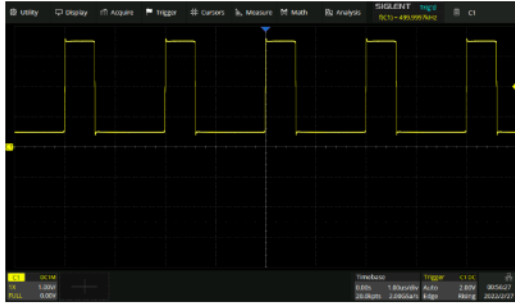

Before invert

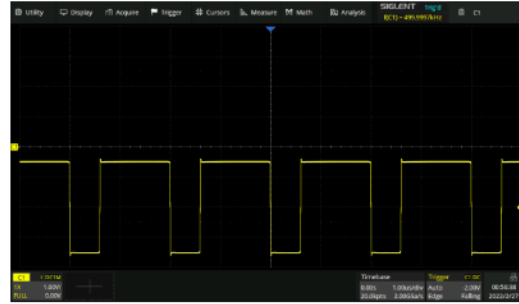

After invert

Trace

When the trace is hidden, the channel waveform is no longer displayed on the screen, while the acquisition is still running in the background.

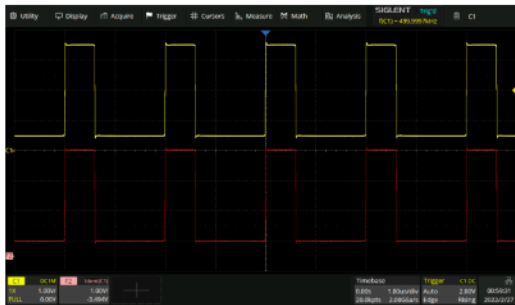

Trace visible

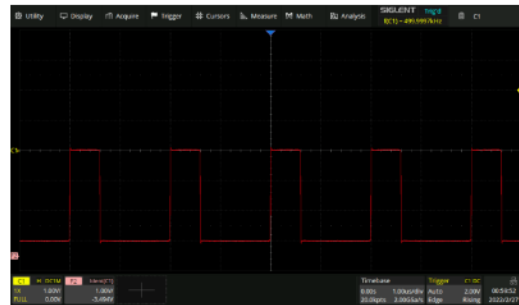

Trace hidden

13 Digital Channels

13.1 Overview

SPL2016 Probe

The SPL2016 is a logic probe designed to monitor up to 16 digital signals at once. The 16 digital channels are separated into two groups and each group has its threshold, making it possible to simultaneously view data from different logic families.



Note: To avoid personal injury or damage to the logic probe and any associated equipment, the following safety precautions should be noted.

The equipment shall be used only for the purposes specified by the manufacturer. The SPL2016 probe is used only for SIGLENT's special series of oscilloscopes. Protection mechanisms can be compromised if the way the devices connected by the SPL2016 are not used for their intended purpose.

Connect and disconnect correctly. Excessive bending can damage the cable.

Do not use equipment in humid or explosive environments.

Only used indoors. The SPL2016 is designed to be used indoors and should only be operated in a clean, dry environment.

Do not use the equipment when you suspect a problem. Do not use the SPL2016 if any parts are damaged. Maintenance work shall be performed by maintenance personnel with appropriate qualifications.

Keep product surface clean and dry.

SDS3000HD-16LA Option

The software option adds the following functions to the oscilloscope:

- **Digital channel acquisition and analysis** -- Acquire and analyze the signals connected to the digital logic probe, including waveform display, save, parameter measurement, etc.
- **Trigger on a digital channel** -- Trigger with the digital channel as the trigger source, isolating events of interest.
- **Decode on a digital channel** -- Serial protocol decoding of a digital channel requires the installation of the serial decode option.

13.2 Enable/Disable the Digital Channels

Turning on or off the digital channels is similar to analog channels. Digital data can be stored as waveform files. Horizontal cursors and most horizontal measurements also apply to digital waveforms.

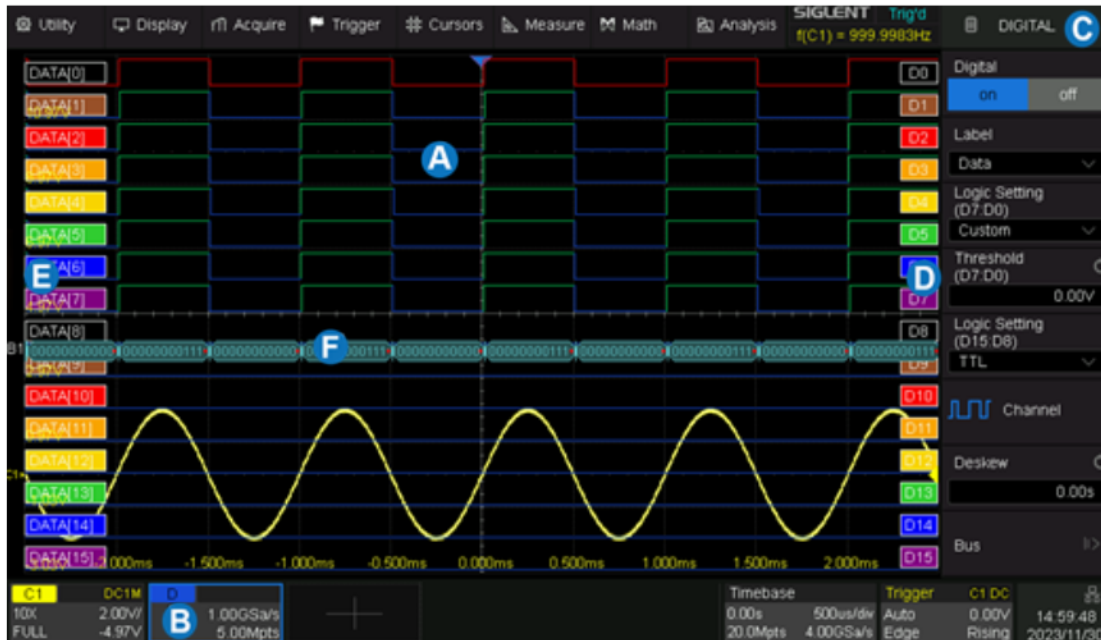

- A. Digital channel waveform display, which shares the same grid area with the analog channels.
- B. Digital channel descriptor box
- C. Dialog box
- D. Digital channel indicators. Up to 16 digital channels are organized in two groups with different thresholds: D15~D8 and D7~D0. Every channel can be turned on or off individually.
- E. Labels can be set to data, address, or custom characters.
- F. Digital bus

From the Front Panel

Press the **Digital** button on the front panel to turn on digital channels and display the waveforms. Press again to turn it off.

From the Touch Screen

Click **+** at the bottom of the display and select the "Digital" to turn it on. Click the digital channel descriptor box, and select **Off** on the pop-up menu to turn it off. Refer to the operation in the chapter "Vertical Setup" for details.

13.3 Digital Channel Setup

Touch the digital descriptor box, then the quick menu of digital channel settings pops up above the descriptor box. In the menu height and position of digital channels can be set:

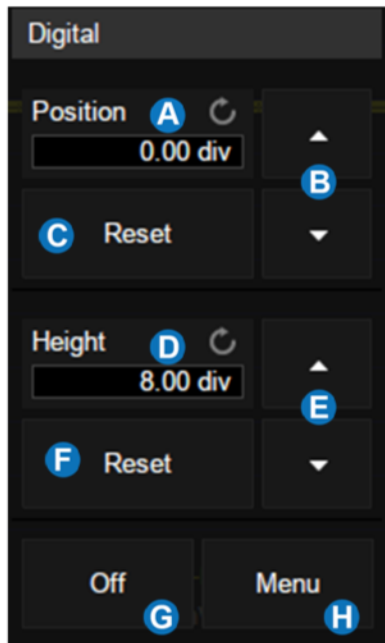

- A. Upper position limit of the digital channel display area. Use the universal knob or virtual keypad to set it. Decrease the height to provide more adjustment area.
- B. ▲ to increase position and ▼ to decrease the channel location.
- C. Reset the position to the default value
- D. The range in height of the digital channels display area. Use the universal knob or virtual keypad to set it. If the display height covers all of the available divisions, there will not be room to adjust the position.
- E. ▲ to increase and ▼ to decrease the number of divisions occupied by the digital channels
- F. Reset the height to the default value
- G. Turn off the digital channels
- H. Open the digital dialog box on the right side

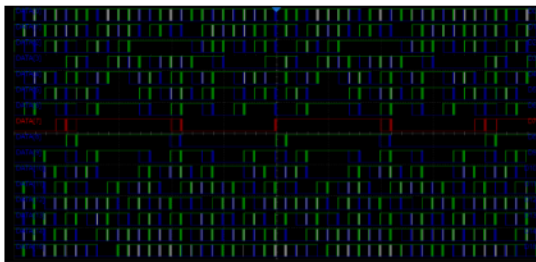

Height=8div, Position=0div

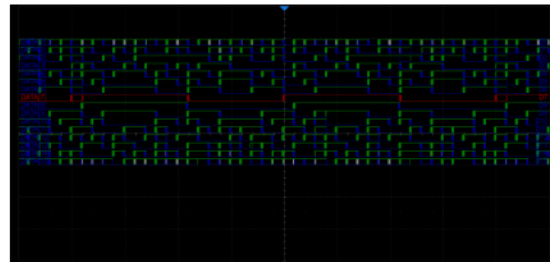

Height=4div, Position=1div

The quick menu only covers the height range and position of the digital channels display area. More settings can be found in the dialog box.

- A. Turn on/off the digital channels
- B. Labels can be set to data, address, or custom characters.
- C. Logic threshold of D7~D0. The oscilloscope will automatically set the threshold according to the specified logic family, or the user can set the threshold manually using the Custom option.
- D. Logic threshold of D15~D8
- E. Set the channels to be displayed
- F. Deskew setting, the same as setting analog channels
- G. Bus setting

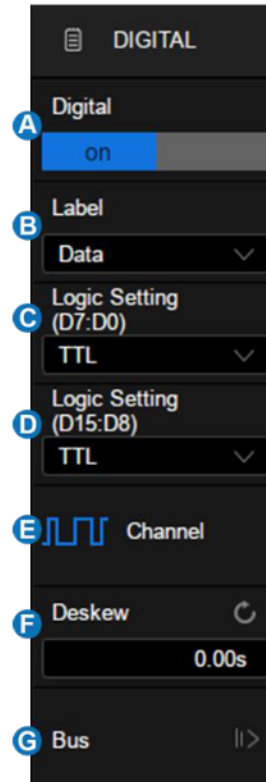

Logic Threshold Setting

The threshold level determines how the input signal is evaluated. The threshold level can be set in the **Logic Setting**. The input voltage less than the threshold is recognized as a '0', and the input voltage greater than the threshold is recognized as a '1'.

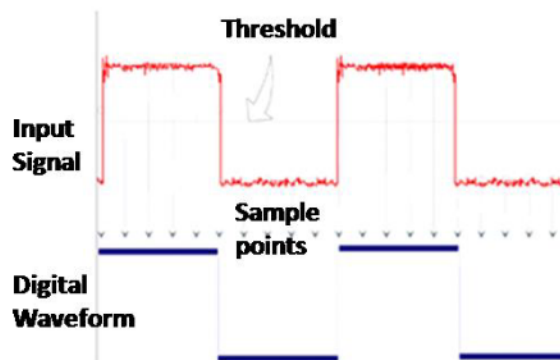

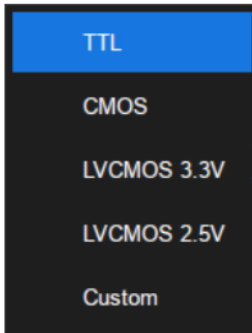

The configurable logical level includes TTL, CMOS, LVCMOS 3.3 V, LVCMOS 2.5 V, and Custom.

The setting range of the custom threshold is -10.0 V to + 10.0 V.

Bus Setting

Press the **Digital** button on the front panel or touch the Digital descriptor box on the bottom to open the Digital dialog box, touch **Bus** to open the Digital Bus dialog box.

- A. Select Bus1 or Bus2
- B. Set the data format of the digital bus (binary, decimal, unsigned decimal, and hexadecimal)
- C. Set the bit width of the digital bus
- D. Set the digital bus data
- E. Reset the digital bus data to the default state
- F. Enable/disable the display of the digital bus
- G. Set the vertical position of the bus
- H. Return to the previous menu



Bus Data Setting

The bus data setting supports setting the digital channel data by bit. Touch **Data** to open the bus data setting dialog.

In this dialog, the mapping relationship between the bus bits and the digital channels is shown as Bit.x[Dy]. For example, Bit.0[D15] means that bit 0 of the bus is D15. Touch **Bit.x[Dy]** to assign the digital channel D0-D15 to the specified bit x.

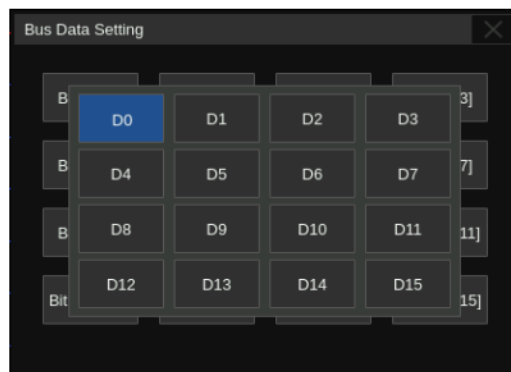
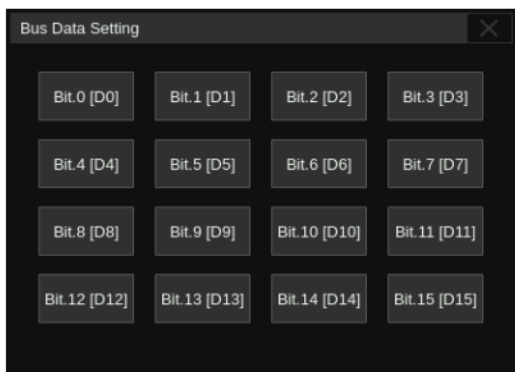

14 Horizontal and Acquisition Setup

14.1 Timebase Setup

The timebase setup is used to adjust the scale and offset of the X (horizontal) axis. This setting applies to all analog, digital channels, and all math traces except FFT.

Touch the timebase descriptor box and the quick menu of the timebase settings will pop up. In the menu timebase (horizontal scale), delay and other parameters can be set.

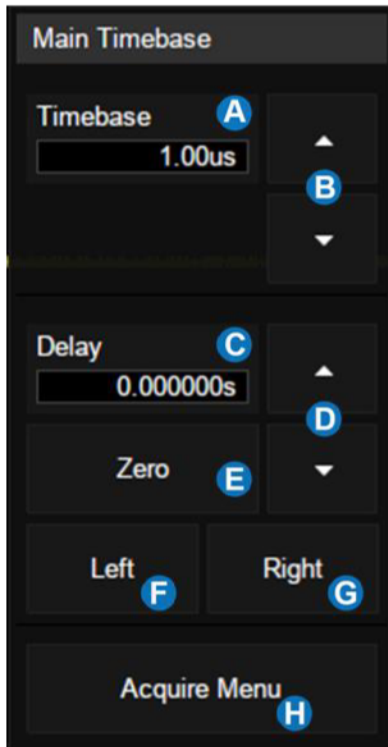

- A. Set the horizontal scale (timebase) by the virtual keypad
- B. ▲ to increase and ▼ to decrease the horizontal scale
- C. Set the trigger delay by the virtual keypad
- D. ▲ to increase and ▼ to decrease the trigger delay
- E. Set the trigger delay to zero
- F. Set the trigger delay to the left part of the screen
- G. Set the trigger delay to the right part of the screen
- H. Open the Acquire dialog box

14.2 Acquisition Setup

14.2.1 Overview

Touch **Acquire Menu** on the quick menu of the timebase settings, or touch the menu bar **Acquire** > **Menu** to recall the Acquire dialog box on the right side.

- A. Select the interpolation mode
- B. Select the Acq mode
- C. Select the acquisition mode (Normal/Peak/Average/ERES). See the section "Acquisition" for details.
- D. Select the Memory Management mode (Auto, Fixed Sample Rate, and Fixed Memory). See the section "Memory Management" for details.
- E. Select the maximum memory depth
- F. Enter the sequence menu. See the section "Sequence" for details
- G. XY mode on/off

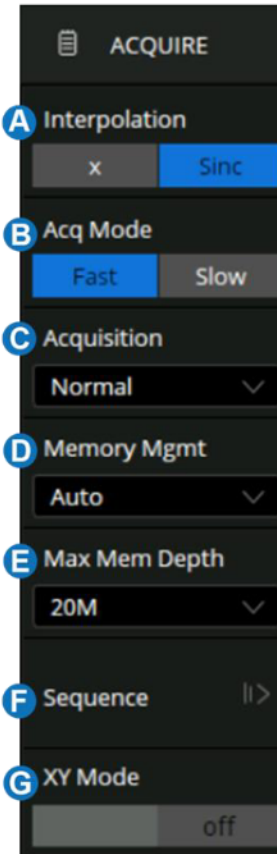

Interpolation -- At small timebase settings, the number of original points on the screen may be less than the number of display pixels in the grid area, so interpolation is necessary to display a continuous waveform. For example, at 1 ns/div timebase and 4 GSa/s sample rate, the number of original points is 40, but the grid area includes 1000 horizontal pixels. In this case, the oscilloscope needs to interpolate the original points by 25.

- **X**: Linear interpolation, the simplest way of interpolation, connects two original points with a straight line.
- **Sinc**: $\text{Sin}(x)/x$ interpolation, the original point is interpolated according to the Nyquist reconstruction formula, which has a good time-domain recovery effect for a sine wave. But for step signals/fast rise times, it will introduce false overshoot due to the Gibbs phenomenon.

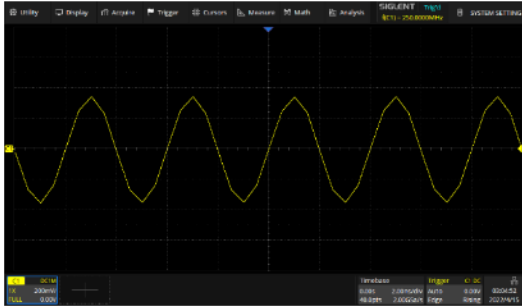

X Interpolation



Sinc Interpolation

Acq Mode: "Fast" is the default setting. The SDS3000X HD provides a very high waveform update rate in fast mode. "Slow" mode will slow down the waveform update on purpose.

Memory Depth: The memory depth that can be supported. According to the formula "acquisition time = sample points x sample interval", setting a larger memory depth can achieve a higher sample rate for a given time base, but more samples require more processing time, degrading the waveform update rate. SDS3000X HD can obtain the best waveform refresh rate with the Memory Depth of 1 kpts. Under the full Memory Depth, SDS3000X HD can still operate at full speed sampling at timebases ≤ 10 ms/div which provides high resolution captures for long time duration events.

The memory depth supported by the SDS3000X HD is listed in the following table:

| Single Channel Mode | Dual-Channel Mode | Quad-Channel Mode |
|---------------------|-------------------|-------------------|
| 2 k | 2 k | 1 k |
| 10 k | 10 k | 5 k |
| 20 k | 20 k | 10 k |
| 100 k | 100 k | 50 k |
| 200 k | 200 k | 100 k |
| 1 M | 1 M | 500 k |
| 2 M | 2 M | 1 M |
| 10 M | 10 M | 5 M |
| 20 M | 20 M | 10 M |
| 100 M | 100 M | 50 M |
| 200 M | 200 M | 100 M |
| 400 M | | |

Single-channel mode: Only one of C1/C2/C3/C4 is turned on.

Dual-channel mode: One of C1&C3 or C2&C4 are turned on.

Quad-channel mode: Three or four of C1/C2/C3/C4 are turned on.

XY Mode: A frame of data input by C1 is used as the x-axis, and a frame of data input by C2 is used as the y-axis to display the relationship between the two signals. XY mode is usually used to draw a Lissajous diagram or volt-ampere diagram of components.

14.2.2 Acquisition

The acquisition mode is used to determine how to acquire and process the signal.

Normal: The oscilloscope samples the signal with equal time intervals. For most waveforms, the best display effect can be obtained using this mode.

Peak: Peak detect mode. The oscilloscope acquires the maximum and minimum values of the signal within the sample interval so the peak (maximum-minimum) in the interval is obtained. This mode is effective to observe occasional narrow pulses or spurs with a low sample rate, but the noise displayed is larger. In peak mode, the oscilloscope will display all pulses with a pulse width longer than 0.5 ns.

In the following example, a narrow pulse sequence with a pulse width of 3.4 ns and a period of 200 Hz is sampled at a 4 MSa/s sample rate in normal mode and peak mode. As we can see, because the sample interval (250 ns) is much larger than the pulse width (3.4 ns), it is difficult to capture the narrow pulses in normal mode, but peak mode can ensure that each pulse is captured.



Normal mode



Peak mode

Average: The oscilloscope accumulates multiple waveform frames and calculates the average as the result. If a stable trigger is available, the resulting average has a random noise component lower than that of a single-shot record. The more frames that are accumulated, the lower the noise is. For the SDS3000X HD, average processing is implemented by the hardware engine, so it can still maintain

a high waveform update rate when the acquisition mode is set to average.

You can reset the accumulated average by pushing the Clear Sweeps button on the front panel.

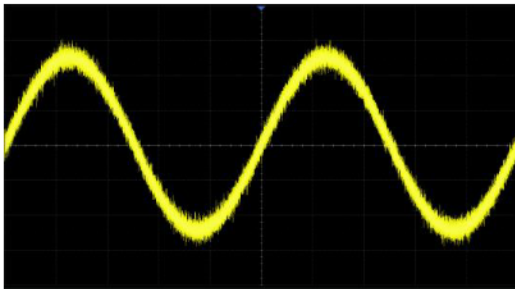

Normal mode

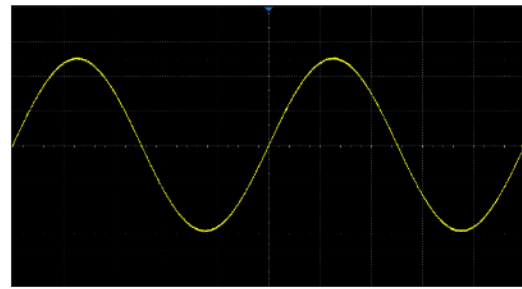

Average mode (128)

Note: Average acquisition is only valid for periodic signals, and it is important to ensure that the waveform is triggering stably when using average mode.

ERES: In this mode, the oscilloscope digitally filters the sampling points, which can reduce the broadband random noise on the input signal and improve the signal-to-noise ratio, to improve the effective resolution (ENOB) of the oscilloscope. The ERES processing of SDS3000X HD is realized by the hardware engine, so it can still maintain a high waveform refresh rate when eres is turned on.

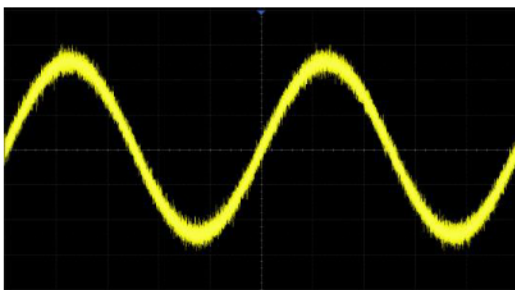

Normal mode

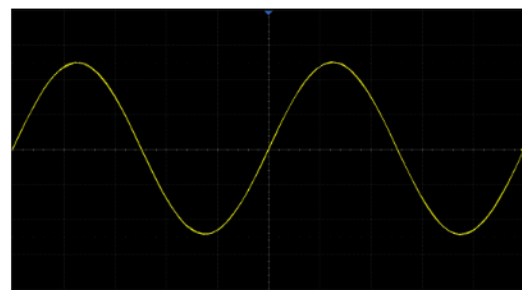

ERES (3-bit)

ERES acquisition does not require the signal to be periodic, nor does it require stable triggering, but due to the digital filtering, the system bandwidth of the oscilloscope will degrade in ERES mode. The higher the enhanced bits, the lower the bandwidth. The following table shows the relationship between ERES bits and bandwidth:

| Enhanced Bits | -3dB bandwidth |
|---------------|-------------------|
| 0.5 | 0.25*Sample rate |
| 1 | 0.115*Sample rate |

| | |
|-----|--------------------|
| 1.5 | 0.055*Sample rate |
| 2 | 0.028*Sample rate |
| 2.5 | 0.014*Sample rate |
| 3 | 0.007*Sample rate |
| 3.5 | 0.0035*Sample rate |
| 4.0 | 0.0017*Sample rate |

14.2.3 Memory Management

Memory Management controls how the instrument stores the acquired samples.

Auto: The default acquisition setting. After setting the maximum memory in the Auto mode, the oscilloscope automatically adjusts the sample rate and memory depth according to the time base. The adjustment principle is to follow the formula:

$$\text{Sample rate} = \text{number of samples} / \text{time of acquisition}$$

Where the time of acquisition is the time corresponding to the full display (i.e. 10 horizontal divisions).

Note: The maximum memory here is the upper limit of the memory space allocated by the oscilloscope. The actual sample points are related to the current time base and may be less than memory depth. The actual sample points information can be obtained in the timebase descriptor box (see the section "Timebase and Trigger" for details).

Fixed Sample Rate: The sample rate is fixed as set, and the oscilloscope automatically adjusts memory depth according to the time base. The time of acquisition is the time corresponding to the full display (i.e. 10 horizontal divisions).

Fixed Memory: The memory depth is fixed as set, and the oscilloscope automatically adjusts the sample rate according to the time base. With a small time scale (such as 1 ns/div) the memory depth is beyond the time of the full display, so it needs to zoom out the acquired frame for viewing the complete frame in Stop mode.

Note: In Run status, the scope only processes the data on the display, which means measure, math, decode, search, etc. analyze only the data on the display. This is identical to the "Auto" memory management mode.

14.2.4 Roll Mode

Press the **Roll** button on the front panel to enter roll mode. In this mode, the waveform moves across the screen from right to left, similar to a strip chart recorder. The horizontal delay control of the waveform will be disabled when roll mode is active. It only operates at timebase values of 50 ms/div and above.

If you would like to stop the display in Roll mode, press the **Run/Stop** button. To clear the display and restart an acquisition in Roll mode, press the **Run/Stop** button again.

14.2.5 Sequence

Touch **Acquire** > **Sequence** to recall sequence dialog box.

- A. Turn on or off sequence
- B. Set the segment

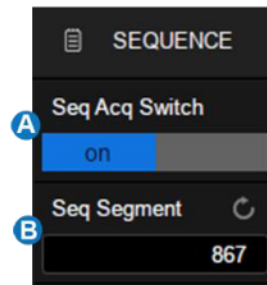

Sequence mode is a fast acquisition mode, which divides the memory depth into multiple segments (up to 80,000), each of which stores a single shot. In sequence mode, the oscilloscope only acquires and stores data without processing and displaying, until the specified segments are acquired. As a result, the dead time between trigger events is minimized, thus greatly improving the waveform update rate. If sequence mode is enabled, the display will not update until all of the sequences have been acquired. The SDS3000X HD can achieve a minimum 1.12 us trigger interval in Sequence mode, corresponding to a waveform update rate of 890,000 wfm/s.

After the acquisition is finished, the oscilloscope will map all the segments together to the screen. If you need to view and analyze each frame separately, history mode will help (see the section "History" for details). History mode provides timestamp labels for each segment.

In addition to minimizing the dead time, another advantage of Sequence mode is that it can capture and record rare events over long periods. The oscilloscope can capture multiple events that satisfy the trigger conditions, ignoring the periods of no interest between adjacent events, thus maximizing the use of waveform memory. You can use the full accuracy of the acquisition timebase to measure selected segments.

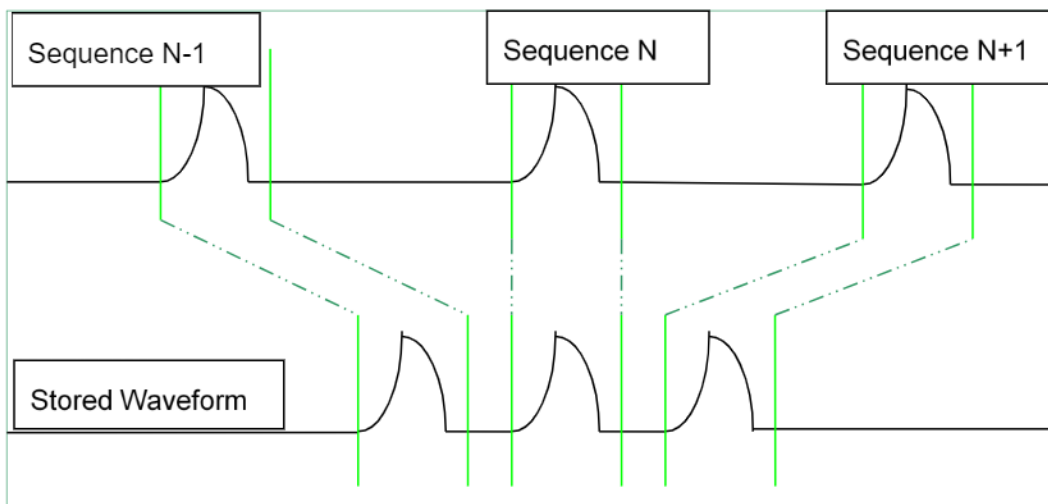

Example:

Input a pulse sequence with a period of 50 ms to C1. The rise time of the pulse is 2 ns, while fall time is 100 ns; pulse width is 108 ns, and amplitude is 1.6 Vpp. Press the **AutoSetup** button on the front panel.

Set the coupling mode of C1 to DC50Ω, and vertical scale to 500 mV/div, vertical offset to 0. Set the trigger level to 0.



In normal mode, 5 pulses can be obtained on the screen with the sample rate of 1GSa/s at the maximum memory depth.

Set the trigger mode to "Single", the timebase to 100 ns/div. Turn on the Sequence mode, and set the segments to maximum (74403 in this example, up to 80,000 depending on the number of samples at

the current time base). Wait patiently until the acquisition completes, then all the waveforms satisfying the trigger conditions are displayed on the screen.



In Sequence mode, there is no waveform displayed on the screen until the acquisition is completed. During acquisition, there is a counter on the screen indicating the number of segments that have been acquired.

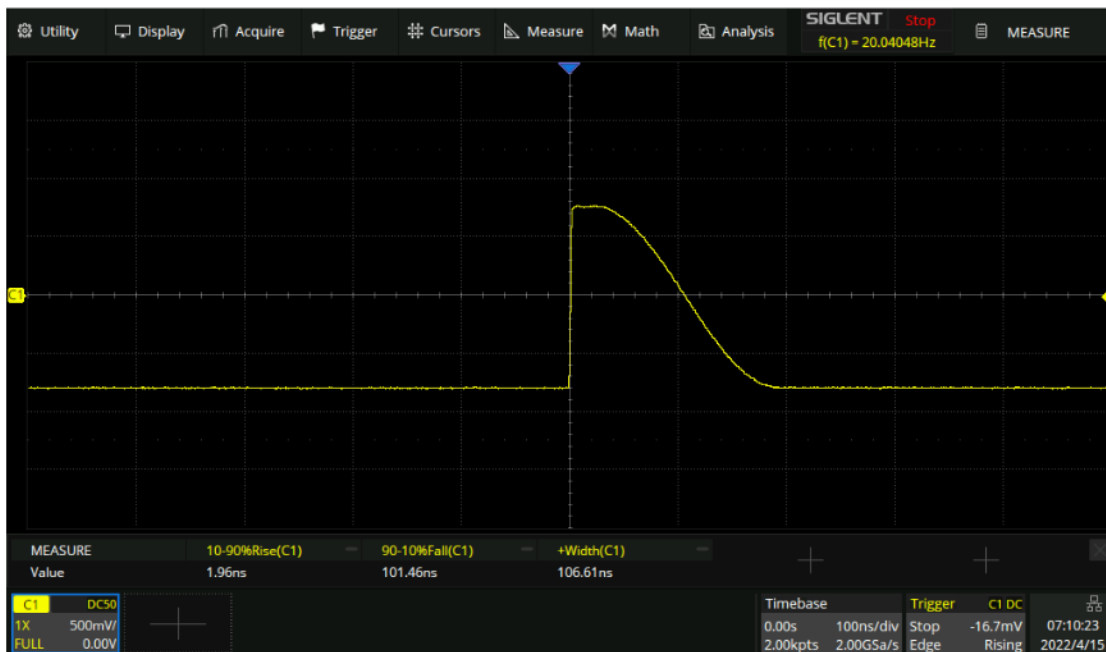

In the example, 74403 pulses can be obtained with the sample rate of 2 GSA/s at the maximum memory depth.

14.3 History

Touch **Analysis** > **History** to recall the history dialog box.

- A. Turn on or off history mode
- B. Specify the frame index
- C. Set the playing mode
- D. Play backward, pause, and play forward
- E. Turn on or off the list
- F. List time type
- G. Set the time interval between two frames when playing automatically
- H. Enable the "Stop on Search Event" function, which allows navigating search events across history frames.
- I. List displays the frame index and time label for each frame.

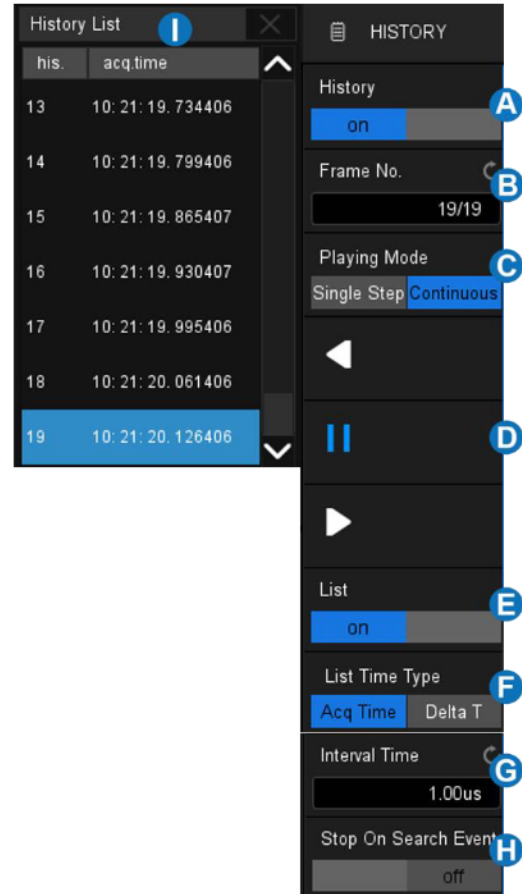

The oscilloscope automatically stores acquired frames. It can store up to 80,000 frames but the number may vary due to the memory depth and timebase settings. Turn on history mode, then the stored frames can be recalled and measured.

Continue with the example in the section above. In Sequence mode, all waveforms that satisfy the trigger conditions are mapped to the display. If you need to observe a single frame, you can use history mode.

To enable history mode, touch the **Frame No.** area twice, then the virtual numeric keypad pops up. Input the number "5412" to specify the 5412th segment (frame).

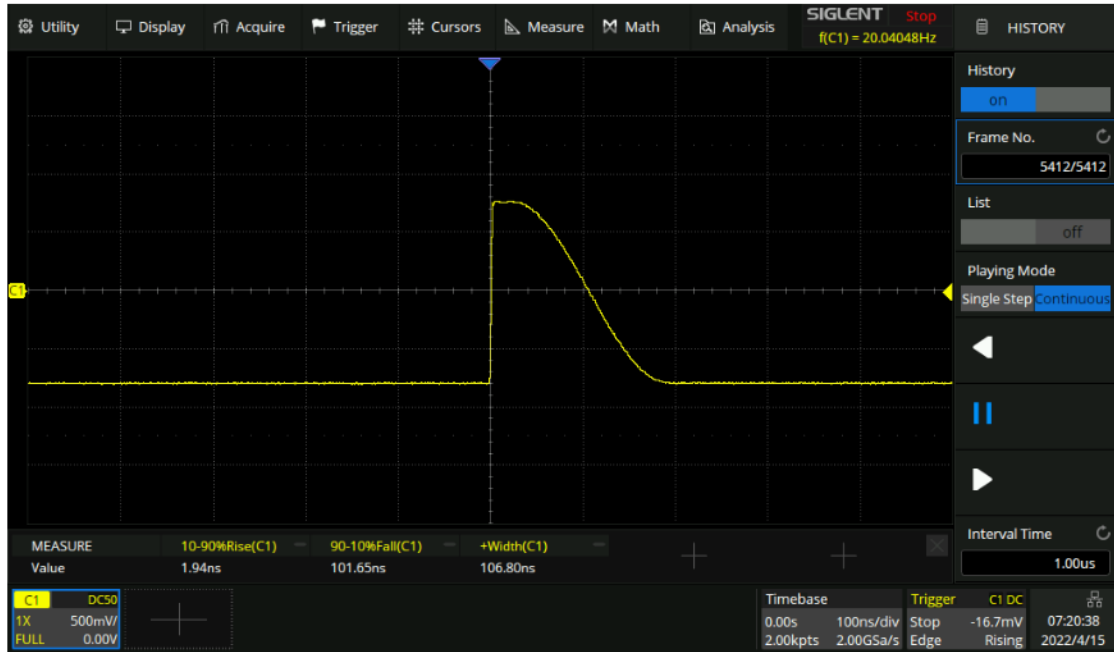

Observing the 5412th frame captured by Sequence in history mode

Touch the **List** area, turn on the list, in which the time label corresponding to the 5412th waveform is displayed. The time resolution is microseconds. Time label types include **AcqTime** or **Delta T**, AcqTime corresponds to the absolute time of the frame, synchronized with the real-time clock of the oscilloscope; Delta T is the acquisition time interval between adjacent two frames, it is shown as 50ms in the following diagram, which is consistent with the period of the actual waveform.

| History List | |
|--------------|--------------------|
| his. | acq.time |
| 5418 | 17: 46: 40. 739616 |
| 5417 | 17: 46: 40. 689616 |
| 5416 | 17: 46: 40. 639616 |
| 5415 | 17: 46: 40. 589616 |
| 5414 | 17: 46: 40. 539616 |
| 5413 | 17: 46: 40. 489616 |
| 5412 | 17: 46: 40. 439616 |

Acq Time label

| History List | |
|--------------|--------------------|
| his. | delta t |
| 5418 | 00: 00: 00. 050000 |
| 5417 | 00: 00: 00. 050000 |
| 5416 | 00: 00: 00. 050000 |
| 5415 | 00: 00: 00. 050000 |
| 5414 | 00: 00: 00. 050000 |
| 5413 | 00: 00: 00. 050000 |
| 5412 | 00: 00: 00. 050000 |

Delta T label

In addition to manually specifying a frame, history mode supports autoplay:

Press the  softkey to replay the waveform from the current frame to the first.

Press the  softkey to stop replay.

Press the  softkey to replay the waveform from the current frame to the last.

Touch the *Interval Time* area to control the speed of automatic play. In the process of automatic play, the list will automatically scroll to the current frame.

Note: When a measurement is enabled in history mode, if the Interval Time is set to small (e.g. in us) the speed of automatic play may not meet the setting, because measurements may take a longer time for each frame.

15 Zoom

The SDS3000X HD supports waveform zoom in the horizontal and vertical directions. Press down the horizontal knob or the  button on the front panel to turn on the zoom function.



When the Zoom function is on, the waveform area is divided into upper and lower parts. The area of about 1/3 height above is the main window, and the area of about 2/3 height below is the zoom window. Touch a window to activate it. The currently activated window is highlighted by the dashed line.

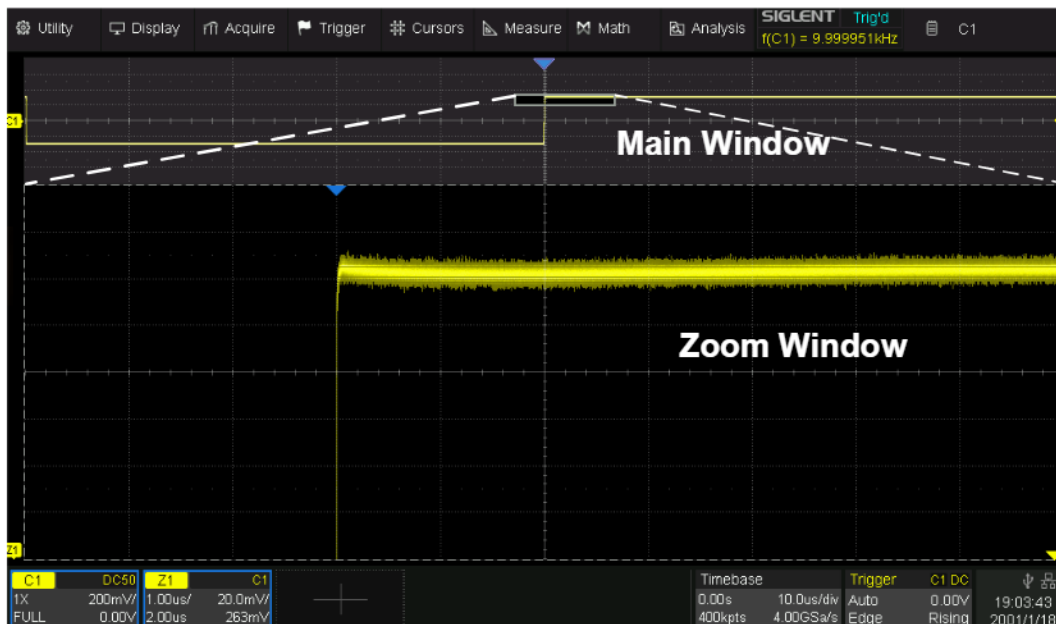

The area not covered by the gray background in the main waveform area is the range to be zoomed in (zoom area). Click the descriptor box of the zoom trace to recall the quick dialogs for setting the vertical and horizontal parameters of the zoom window.

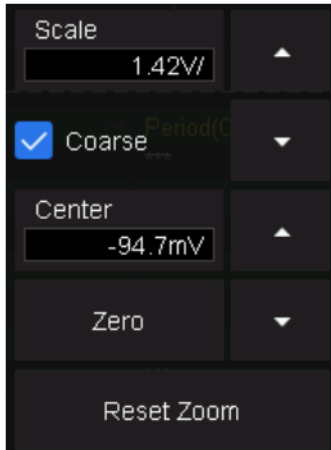

Vertical setting

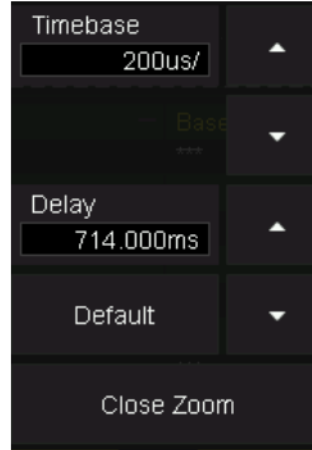

Horizontal setting

When the zoom window is activated, the zoom area can be expanded or compressed by rotating the horizontal and vertical scale knob. Rotating the horizontal and vertical position knob to move the position of the region. When the main window is activated, the scale knobs and position knobs are used to change the scale and delay/offset of the main window. The operations above can also be performed by different gestures. Below is the example of changing the setting in the horizontal direction by gestures. The gestures for changing the setting in the vertical direction are similar.



Adjust the horizontal position of the zoom area by dragging left and right in the zoom area of the main window or waveform in the Zoom window

Adjust the vertical position of the zoom area by dragging up and down in the zoom area of the main window or waveform in the Zoom window.

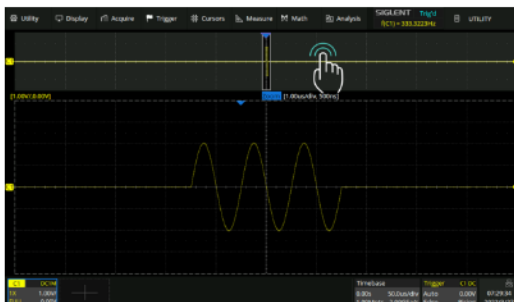

Double click a location in the main window to quickly set the center of the zoom area.



Adjust the horizontal position of the waveform by dragging left and right in the gray area of the main window

Adjust the vertical position of the waveform by dragging up and down in the gray area of the main window.



Adjust the horizontal scale of the Zoom window by horizontal pinch and spread in the zoom area of the main window or the Zoom window

Adjust the vertical scale of the Zoom window by vertical pinch and spread in the zoom area of the main window or the Zoom window.



Adjust the horizontal/ vertical scale of the main window by using a pinching or spreading gesture in the gray area of the main window

Note: Zoom traces (Z1~Z4) can be used as the source of Measurement, Math, Mask test, and Histogram.

16 Trigger

16.1 Overview

The oscilloscope only acquires waveforms of interest (i.e. the ones that satisfy the trigger condition) and aligns all trigger events at the trigger position to form a stable waveform display. The trigger is one of the most important features of an oscilloscope since we can only analyze a signal that we can trigger reliably and stably.

The trigger position is movable on the display. The following diagram shows the structure of the acquisition memory. The acquisition memory is divided into pre-trigger and post-trigger buffers and the boundary between them is the trigger position. Before the trigger event arrives, the oscilloscope fills the pre-trigger buffer first, and then continuously updates it in FIFO mode until the trigger event arrives. After the trigger event, the data fills the post-trigger buffer. When the post-trigger buffer is full, an acquisition is completed.

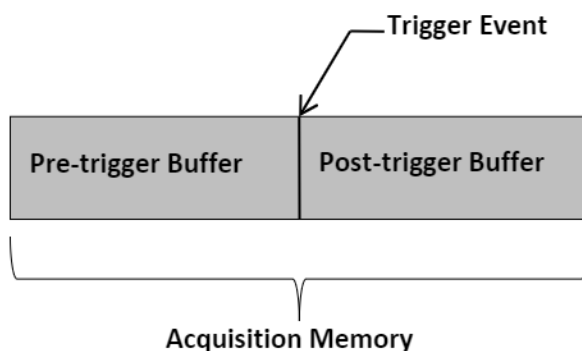

Below is the definition of the states in the process of filling the acquisition memory:

Arm: The pre-trigger buffer is not full, and the oscilloscope does not respond to any trigger events.

Ready: The pre-trigger buffer is full, and the oscilloscope is waiting for the trigger event.

Trig'd: A trigger event is detected and the oscilloscope starts to fill the post-trigger buffer.

Trigger settings should be based on the features of the input signal. For example, a sine wave with a repeatable period can be triggered on the rising edge; for capturing hazards in a combinational logic circuit, the pulse trigger can be set. You need to have some knowledge of the signal-under-test to quickly capture the desired waveform.

16.2 Trigger Setup

Touch the trigger descriptor box to display the quick menu of trigger settings. The trigger setup dialog box is displayed on the right side of the screen.

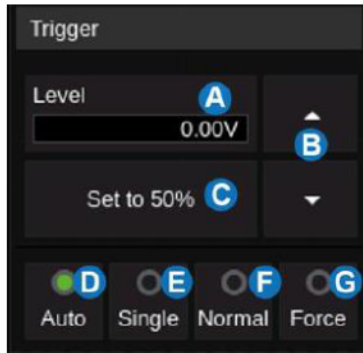

Quick menu

- A. Touch the level region and rotate the **Level** knob on the front panel to adjust the trigger level; touch the region again and the virtual keypad will be available
- B. ▲ to increase and ▼ to decrease the trigger level
- C. Set trigger level to the vertical center of the waveform automatically
- D. Set the trigger mode to "Auto", which is equivalent to pressing the `Auto` button on the front panel
- E. Set the trigger mode to "Single", which is equivalent to pressing the `Single` button on the front panel
- F. Set the trigger mode to "Normal", which is equivalent to pressing the `Normal` button on the front panel
- G. Perform a force trigger

Trigger setup dialog box:

- A. Select trigger type
- B. Select the trigger source
- C. Select the trigger slope (When the trigger type is "Edge", "Slope" and other specific types)
- D. Set holdoff (None/Time/Events)
- E. Set trigger coupling mode (DC/AC/LF Reject/HF Reject)
- F. Enable/disable Noise Rejection. When Noise Reject is on, the trigger hysteresis is increased, so the noise immunity of the trigger circuit is better. As a compromise, the trigger sensitivity degrades
- G. Set the Zone trigger

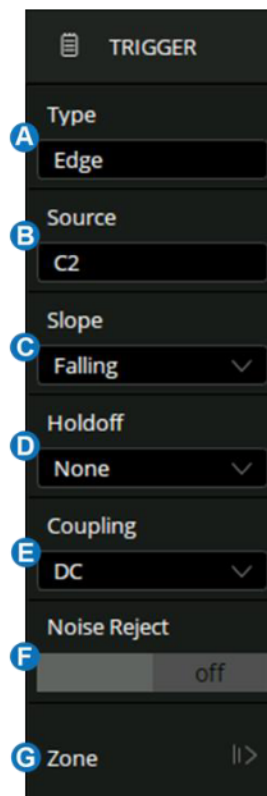

Trigger Related Label

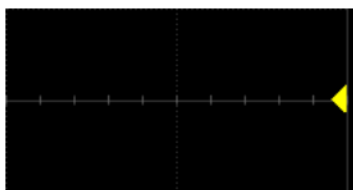

Trigger level Indicator

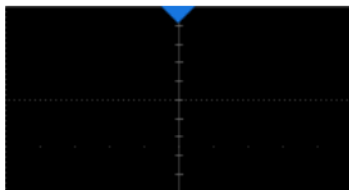

Horizontal 0 position Indicator



Horizontal 0 position (out of screen) Indicator

16.3 Trigger Level

Both analog and digital triggers must have a correct trigger level value. The oscilloscope judges whether a waveform satisfies the trigger condition when it crosses the trigger level. If it does, the crossing time is the trigger position. In the following figure, the trigger condition is set as a rising edge. When the signal with a positive slope crosses the trigger level, the trigger condition is satisfied and the time point the signal crosses the level is the trigger position.

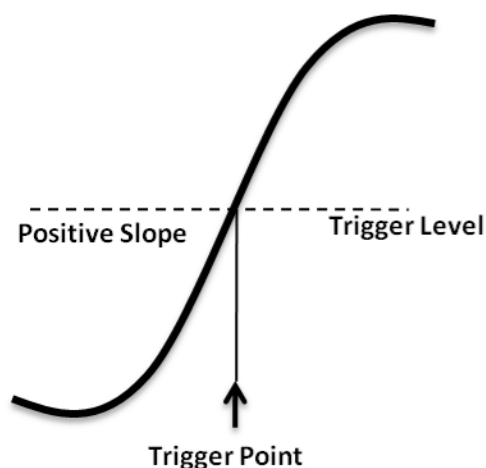

In some special triggers, the system will automatically set the trigger level, such as using AC Line as the trigger source.

16.4 Trigger Mode

The trigger mode determines how the oscilloscope acquires waveforms.

Auto: An internal timer triggers the sweep after a preset timeout period if no trigger has been found so that the oscilloscope continuously updates the display whether a trigger happens or not. Auto mode is suitable for unknown signals or DC signals.

Note: In Auto mode, if the signal satisfies the trigger conditions but cannot trigger the oscilloscope stably, it may be that interval between two trigger events exceeds the timeout period. Try Normal mode in this case.

Normal: Triggers and acquisitions only occur when the trigger conditions are met. Otherwise, the oscilloscope holds the last waveform on the display and waits for the next trigger. Normal mode is suitable for acquiring:

- Only events specified by the trigger settings
- Rare events

Single: Captures and displays a single frame that satisfies the trigger conditions, and then stops. The following trigger events are ignored until the Single acquisition is restarted. Single-mode is suitable for:

- One-shot events or periodic signals, such as power-on/off waveforms on a power rail
- Rare events

Force: The oscilloscope performs an acquisition regardless of whether the input signal meets the trigger conditions or not. Press twice to perform a force trigger.

16.5 Trigger Type

16.5.1 Overview

The trigger modes of the SDS3000X HD are digital designs. Compared with analog trigger circuits, digital triggers can not only greatly optimize trigger precision and trigger jitter, but also support multiple trigger types and complex trigger conditions.

| | |
|---|---|
|  | Edge -- Trigger on a rising edge, falling edge or both |
|  | Slope -- Trigger when an edge crosses two thresholds that lie inside or outside a selected time range |
|  | Pulse -- Trigger at the end of a pulse when the pulse width lies inside or outside a selected time range |
|  | Video -- TV trigger on falling edge |
|  | Window -- Trigger when the signal leaves the window region. |
|  | Interval -- Trigger on the second edge when the time between the edges is inside or outside a selected time range |
|  | Dropout --Trigger when the signal disappears for longer than the Dropout value. |
|  | Runt --Trigger when a pulse crosses the 1st threshold but not the 2nd before re-crossing the 1st threshold again |
|  | Pattern -- Trigger when pattern condition transitions from false to true. All inputs set to DC coupling |
|  | Serial --Trigger on specified condition in a serial bus. See the chapter "Serial Trigger and Decode" for details. |
|  | Qualified -- Trigger with edge trigger setting only after the qualifying condition is satisfied |
|  | Nth Edge --Trigger on the Nth edge of a burst that occurs after a specified idle time |
|  | Delay --Trigger when the delay time between source A and source B meets the limit condition |
|  | Setup/Hold --Trigger when the setup time or hold time meets the limit condition |

16.5.2 Edge Trigger

Edge trigger distinguishes the trigger points by seeking the specified edge (rising, falling, alternating) and trigger level. The trigger source and slope can be set in the trigger dialog box.

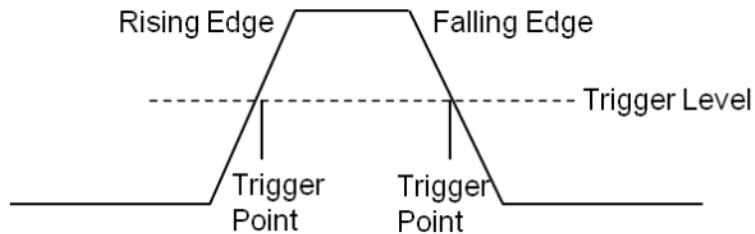

Touch the **Source** area to select trigger source, and touch the **Slope** area to select rising, falling, or alternating.

Rising -- Only trigger on the rising edge

Falling -- Only trigger on the falling edge

Alternating -- Trigger on both rising edge and falling edge

Holdoff, coupling, and noise reject can be set in edge trigger, see the sections "Holdoff", "Trigger Coupling" and "Noise Reject" for details.

Note: Press the **Auto Setup** button, and the oscilloscope will set the trigger type to Edge.

16.5.3 Slope Trigger

The slope trigger looks for a rising or falling transition from one level to another level in the specified time range. For example, positive slope time is defined as the time difference between the two crossing points of trigger level lines A and B with the positive edge as shown in the figure below.

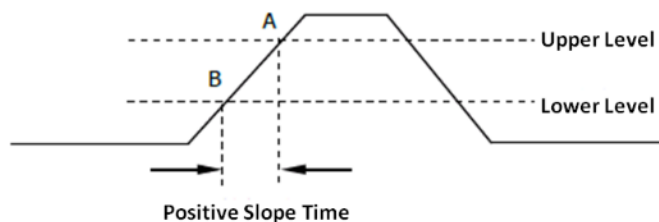

Touch the **Source** area to select trigger source, and touch the **Slope** area to select rising or falling.

Rising -- Only trigger on the positive slope

Falling -- Only trigger on the negative slope

Adjust Upper/Lower Level

The slope trigger requires upper and lower trigger levels. When the trigger type is slope trigger, touch the trigger descriptor box, and the pop-up quick menu will show two levels.



The upper/lower level can be set in the following two ways:

1. Touch the **Level Upper** area in the quick menu to select the upper level, and then set the level value by the virtual keypad or the **Level** knob on the front panel. To set the lower level is similar.
2. Use the **Level** knob on the front panel directly to set the level value. Press the knob to switch between upper and lower levels, and rotate it to set the value.

The lower level should always be less than or equal to the upper level. In the trigger descriptor box, the lower level is displayed.

Set Limit Range

Touch the **Limit Range** area in the trigger dialog box to select the time condition and set the corresponding time in the **Upper Value** / **Lower Value** area.

Less than a time value (\leq) -- Trigger when the positive or negative slope time of the input signal is lower than the specified time value.

Great than a time value (\geq) -- Trigger when the positive or negative slope time of the input signal is greater than the specified time value.

Within a range of time values ([--,--]) -- Trigger when the positive or negative slope time of the input signal is greater than the specified lower limit of time and lower than the specified upper limit of time value.

Outside a range of time value (--][--) -- Trigger when the positive or negative slope time of the input signal is greater than the specified upper limit of time and lower than the specified lower limit of time value.

Holdoff, coupling, and noise reject can be set in slope trigger, see the sections "Holdoff", "Trigger Coupling" and "Noise Reject" for details.

16.5.4 Pulse Trigger

Trigger on a positive or negative pulse with a specified width. Trigger source, polarity (positive, negative), limit range, and time value can be set in the trigger dialog box.

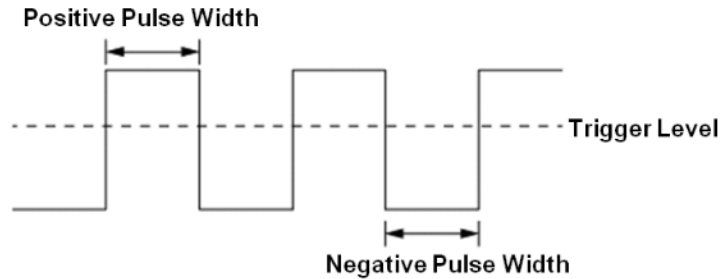

Less than a time value (\leq) -- Trigger when the positive or negative pulse time of the input signal is lower than the specified time value. Below is an example of a trigger condition set to a positive pulse width $< 100\text{ns}$.



Great than a time value (\geq) -- Trigger when the positive or negative pulse time of the input signal is greater than the specified time value. Below is an example of a trigger condition set to a positive pulse width $> 100\text{ns}$.



Within a range of time values ($[-, -]$) -- Trigger when the positive or negative pulse time of the input signal is greater than the specified lower limit of time and lower than the specified upper limit of the time value. Below is an example of a trigger condition set to $100\text{ ns} < \text{positive pulse width} < 300\text{ ns}$.

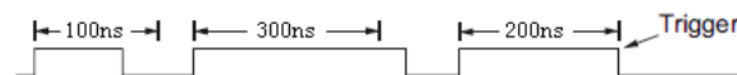

Outside a range of time value ($--][--]$) -- trigger when the positive or negative pulse time of the input signal is greater than the specified upper limit of time and lower than the specified lower limit of the time value.

Holdoff, coupling, and noise reject can be set in pulse trigger, see the sections "Holdoff", "Trigger Coupling" and "Noise Reject" for details.

16.5.5 Video Trigger

Video trigger can be used to capture the complicated waveforms of most standard analog video signals. The trigger circuitry detects the vertical and horizontal interval of the waveform and produces a trigger based on the video trigger settings you have selected. The SDS3000X HD supports standard video signals for NTSC (National Television Standards Committee), PAL (Phase Alternating Line), HDTV (High Definition Television), and a custom video signal trigger.

Source, standard, and synchronization mode can be set in the video trigger dialog box. When the synchronization mode is "Select", line and field can be specified.

Touch the **Standard** and select the video standard. The SDS3000X HD supports the following video standards:

| TV Standard | Scan Type | Sync Pulse |
|---------------|-------------|------------|
| NTSC | Interlaced | Bi-level |
| PAL | Interlaced | Bi-level |
| HDTV 720P/50 | Progressive | Tri-level |
| HDTV 720P/60 | Progressive | Tri-level |
| HDTV 1080P/50 | Progressive | Tri-level |
| HDTV 1080P/60 | Progressive | Tri-level |
| HDTV 1080i/50 | Interlaced | Tri-level |
| HDTV 1080i/60 | Interlaced | Tri-level |
| Custom | | |

The table below shows the parameters of the custom video trigger:

| | | |
|------------------|--------------------------|-------|
| Frame Rate | 25Hz, 30 Hz, 50 Hz,60 Hz | |
| Of Lines | 300 ~ 2000 | |
| Of Fields | 1,2,4,8 | |
| Interlace | 1:1, 2:1,4:1,8:1 | |
| Trigger Position | Line | Field |

| | | |
|--|----------------------|-------------------|
| | (line value)/1(1:1) | 1 |
| | (line value)/2 (2:1) | 1,2, 3, 4,5,6,7,8 |
| | (line value)/4(4:1) | 1,2, 3, 4,5,6,7,8 |
| | (line value)/8(8:1) | 1,2, 3, 4,5,6,7,8 |

Line value: The number of lines set in the **Of Lines** (300 ~ 2000).

In the custom video trigger type, the corresponding "Of Fields" varies with the selection of the "Interlace" ratio. Therefore, the number of fields selected and the number of lines corresponding to each field can also be varied. If the "Of Lines" is set to 800, the correct relationship between them is as follows:

| Of Lines | Interlace | Of Fields | Trigger Line | Trigger Field |
|----------|-----------|-----------|--------------|---------------|
| 800 | 1:1 | 1 | 800 | 1 |
| 800 | 2:1 | 1/2/4/8 | 400 | 1/1~2/1~4/1~8 |
| 800 | 4:1 | 1/2/4/8 | 200 | 1/1~2/1~4/1~8 |
| 800 | 8:1 | 1/2/4/8 | 100 | 1/1~2/1~4/1~8 |

Set the video trigger for a video signal

Touch **Sync** for trigger mode selection, video trigger mode has "Any" and "Select" options. In "Any" mode, the video signal can be triggered on any line that meets the conditions. In the "Select" mode, the signal can be triggered by a specified field and a specified line.

For progressive scanning signals (e.g. 720p/50, 720p/60, 1080p/50, 1080p/60), only the specified line can be selected to trigger when the synchronization mode is "Select".

For interlaced scanning signals (such as NTSC, PAL, 1080i/50, 1080i/60, Custom), when the synchronization mode is "Select", the specified line and the specified field can be selected to trigger.

The following table shows the corresponding relations between line and field for all video standards (except for Custom)

| Standard | Field 1 | Field 2 |
|----------|----------|----------|
| NTSC | 1 to 263 | 1 to 262 |

| | | |
|--------------------------|-----------|----------|
| PAL | 1 to 313 | 1 to 312 |
| HDTV 720P/50 , 720P/60 | 1 to 750 | |
| HDTV 1080P/50 , 1080P/60 | 1 to 1125 | |
| HDTV 1080i/50 , 1080i/60 | 1 to 563 | 1 to 562 |

To gain familiarization with the video trigger, try these two examples:

- Trigger on a specific line of video (NTSC standard)
- Use "Custom" to trigger video signals

Trigger on a Specific Line of Video

Video trigger requires that any analog channel can be used as the trigger source with a synchronization amplitude greater than 1/2 grid. The example below sets to trigger on Field 1, Line 22 using the NTSC video standard.

1. Press the **Setup** button on the front panel to open the trigger menu.
2. In the trigger menu, touch **Type** , and select "Video".
3. Touch the **Source** and select C1 as the trigger source.
4. Touch the **Standard** and select the "NTSC".
5. Touch the **Sync** and select the "Select" to make the Field and Line optional, then select "1" in the "Field", and set the "Line" to "22" by using the universal knob or the virtual keypad.

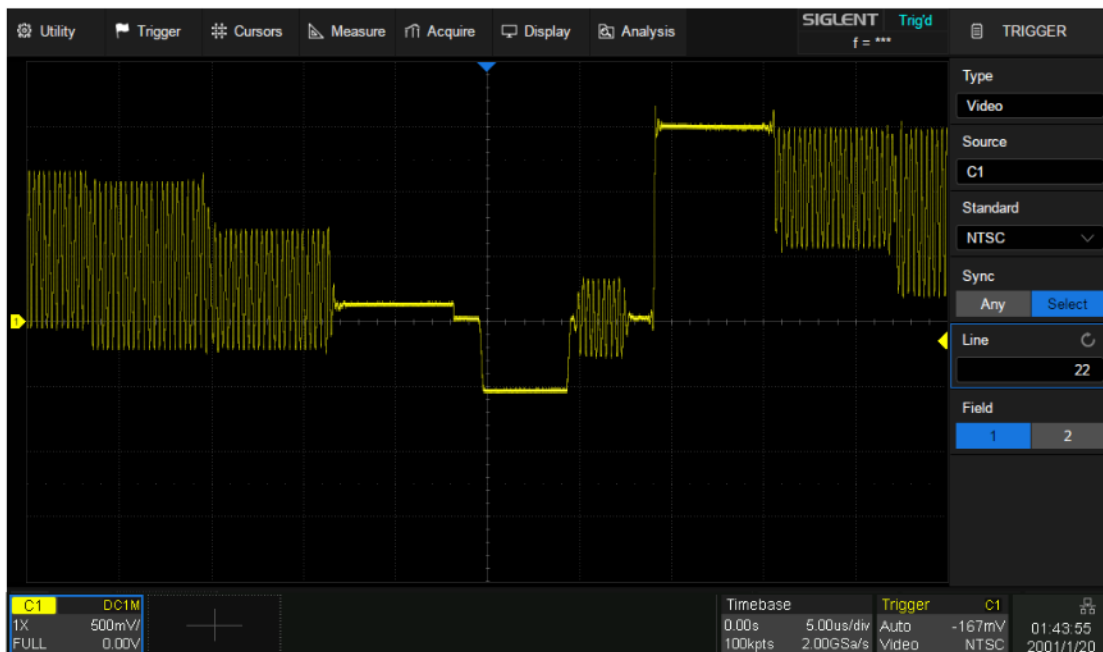

Trigger on a Specific Line of Video (NTSC)

Use "Custom" to Trigger Video Signals

Custom video trigger supports video signals with frame rates of 25, 30, 50, and 60 Hz respectively, and the specified row is within the range of 300 to 2000. The following describes how to trigger a "Custom" video signal.

1. Press the **Setup** button on the front panel to open the trigger menu.
2. In the trigger menu, touch the **Type** , and select the "Video".
3. Touch the **Source** and select C1 as the trigger source.
4. Touch the **Standard** and select the "Custom".
5. Touch the **Custom Setting** to open the custom setting menu, and touch the **Interlace** to select the required interlace ratio (assuming that the interlace ratio is 8:1). Then set the frame rate, select the number of lines and the number of fields.
6. Touch the **Sync** to select the synchronization mode for the input signal:
 - a) Select the "Any" mode, and the signal can be triggered on any line that meets the trigger condition.
 - b) Select the "Select" mode, then set the specified line and the specified field to trigger the signal. Assuming that the "Field" is set to 8, you can select any field from 1 to 8, and each field can choose any line from 1 to 100.

16.5.6 Window Trigger

The window trigger is similar to the edge trigger, except that it provides an upper and a lower trigger level. The instrument triggers when the input signal passes through the upper level or the lower level.

There are two kinds of window types: Absolute and Relative. They have different trigger level adjustment methods. Under the Absolute window type, the lower and the upper trigger levels can be adjusted separately. The relative window provides adjustment for the Center value to set the window center and the Delta value to set the window range. In this mode, the lower and the upper trigger levels always move together.

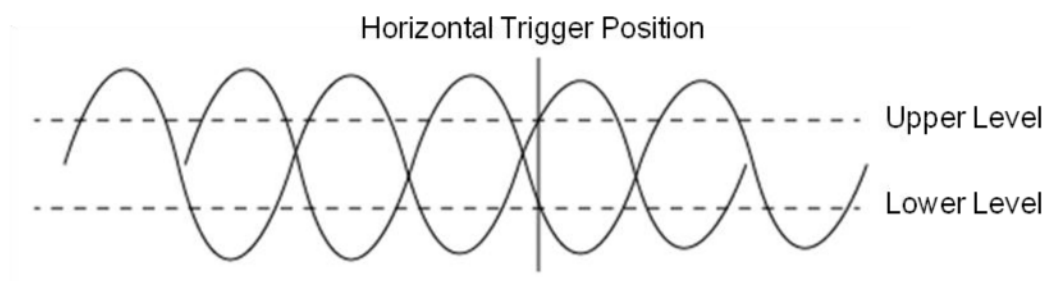

- If the lower and the upper trigger levels are both within the waveform amplitude range, the oscilloscope will trigger on both rising and falling edges.
- If the upper trigger level is within the waveform amplitude range while the lower trigger level is

out of the waveform amplitude range, the oscilloscope will trigger on the rising edge only.

- If the lower trigger level is within the waveform amplitude range while the upper trigger level is out of the waveform amplitude range, the oscilloscope will trigger on the falling edge only.

To set window trigger via the Absolute window type

Refer to "Adjust Upper/Lower Level" in the section "Slope Trigger".

To set window trigger via the Relative window type

When the window trigger type is set to "Relative", touch the trigger descriptor box. The pop-up menu will show two user-defined parameters: "Level +/-Delta" and "Level Center".

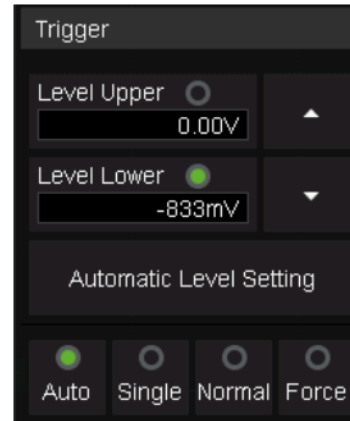

The above two parameters can be set in the following two ways:

1. Select the parameter in the **Level +/-Delta** area of the quick menu, then set the parameter value by the virtual keypad or the Level knob on the front panel. To set the center level is similar.
2. Directly use the **Level** knob on the front panel. Press the knob to switch between "Level +/-Delta" and "Level Center", and rotate it to set values.

Note: "Level +/-Delta" represents half of the actual window area. For example, when the value is 200mV, it represents a range of ± 200 mV, which is a 400mV window.

Holdoff, coupling, and noise reject can be set in window trigger, see the sections "Holdoff", "Trigger Coupling" and "Noise Reject" for details.

16.5.7 Interval Trigger

Trigger when the time difference between the neighboring rising or falling edges meets the time limit condition.

When the trigger condition is set as an interval between two neighboring rising edges and it is less than the set time value, the trigger diagram is as follows:

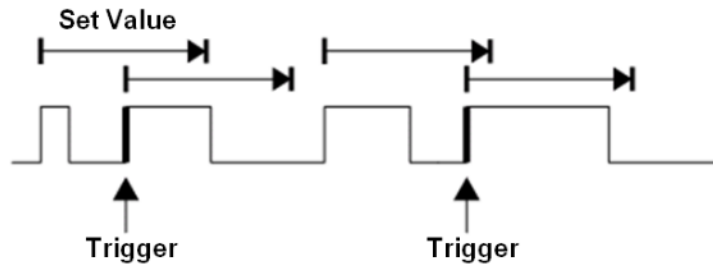

Trigger source, slope (rising, falling), limit range, and time value can be set in the trigger dialog box. Holdoff, coupling, and noise reject can be set in interval trigger, see the sections "Holdoff", "Trigger Coupling" and "Noise Reject" for details.

16.5.8 Dropout Trigger

Dropout trigger includes two types: Edge and State.

Edge

Trigger when the time interval (ΔT) from when the rising edge (or falling edge) of the input signal passes through the trigger level to when the neighboring rising edge (or falling edge) passes through the trigger level is greater than the set time, as shown in the figure below:

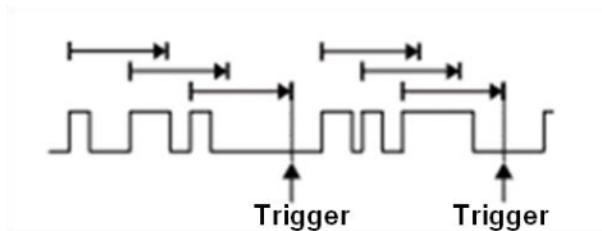

State

Trigger when the time interval (ΔT) from when the rising edge (or falling edge) of the input signal passes through the trigger level to when the neighboring falling edge (or rising edge) passes through the trigger level is greater than the set time, as shown in the figure below:

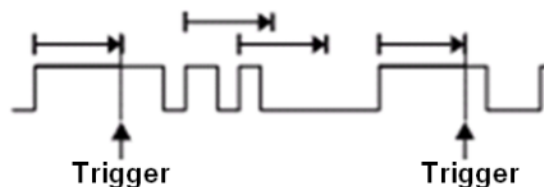

Trigger source, slope (rising, falling), dropout type, and time value can be set in the trigger dialog box. Holdoff, coupling, and noise reject can be set in the dropout trigger, see the sections "Holdoff", "Trigger Coupling" and "Noise Reject" for details.

16.5.9 Runt Trigger

Runt trigger looks for pulses that cross one threshold but not another as shown in the figure below:

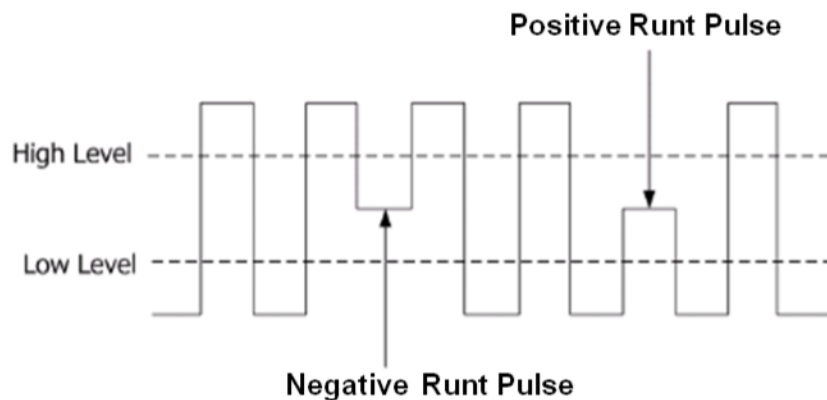

- A positive runt pulse across through the low level but not the high level.
- A negative runt pulse across through the high level but not the low level.

Holdoff, coupling, and noise reject can be set in the runt trigger, see the sections "Holdoff", "Trigger Coupling" and "Noise Reject" for details.

16.5.10 Pattern Trigger

The Pattern trigger identifies a trigger condition by looking for a specified pattern. The SDS3000X HD provides 4 patterns: logical AND, OR, NAND and NOR combination of the channels. Each channel can be set to "Low", "High" or "Don't Care". If all channels are set to "Don't Care", the oscilloscope will not trigger. The result after the logical operation is triggered from true to false, that is, triggers on the falling edge of the combined waveform.

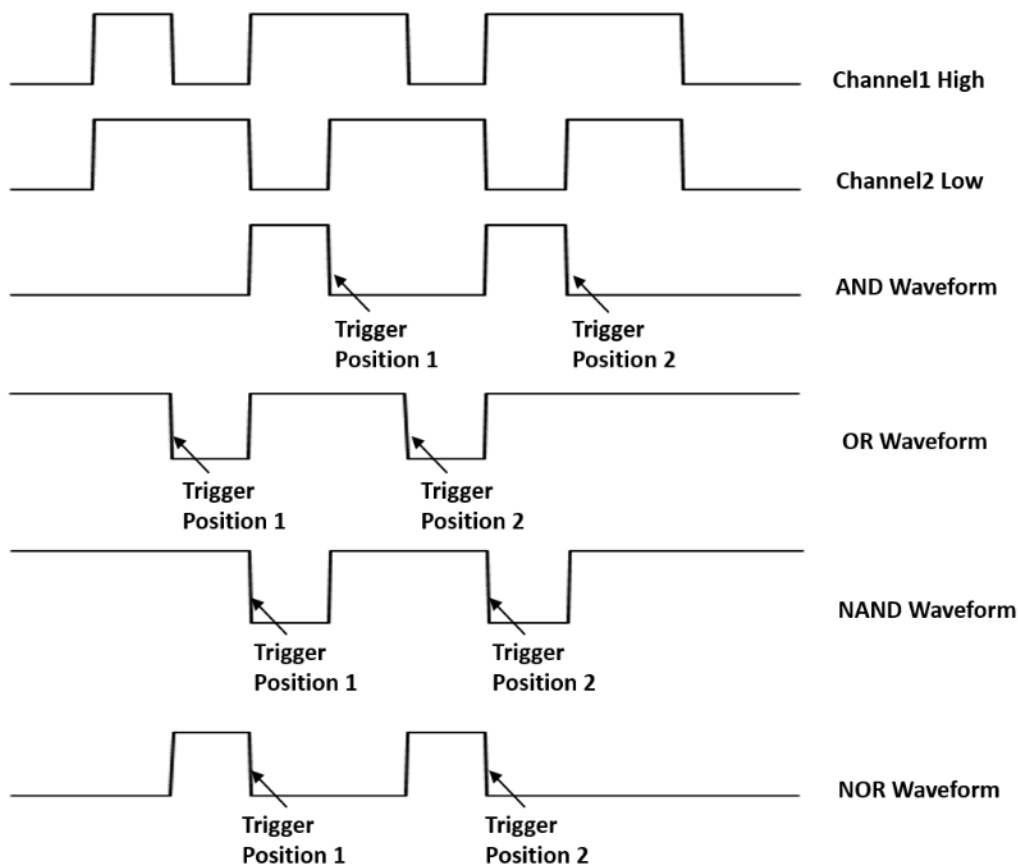

Logic (AND, OR, NAND, NOR), source, limit range, and time value can be set in the trigger dialog box.

Source Setting

Touch the **Source Setting** area to recall the following dialog box and set up for each channel separately. Each channel can be set to "Low", "High" or "Don't Care". The threshold can be determined by setting the **Level Value**.

When digital channels are turned on, the logic state of the digital channel can also be set in the source setting dialog box.

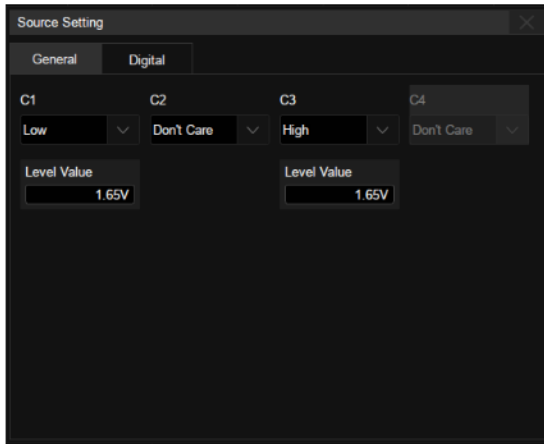

The logical setting of analog channels

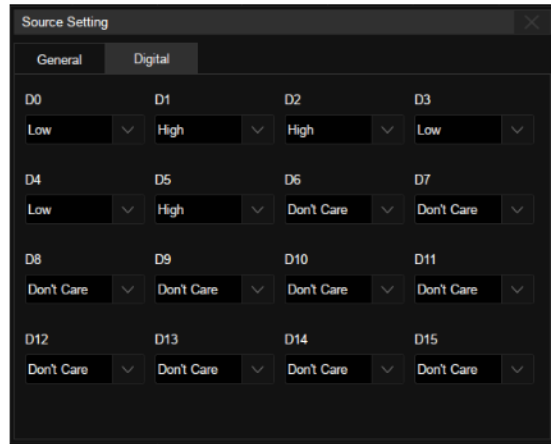

The logical setting of digital channels

Limit Range

This setting is particularly useful to filter the hazard signals of combinational logic.

Holdoff can be set in pattern trigger, see the section "Holdoff" for details.

16.5.11 Qualified Trigger

The qualified trigger is an edge trigger after a user-defined qualified condition is satisfied. So a qualified trigger has two sources; one is the source of the edge trigger, and the other is the qualified source.

The qualified types include "State", "State with Delay", "Edge", and "Edge with Delay". When the type is "State", the oscilloscope triggers on the first edge when the qualified source is in the specified state (High or Low). When the type is "State with Delay", a time limit condition is also available.

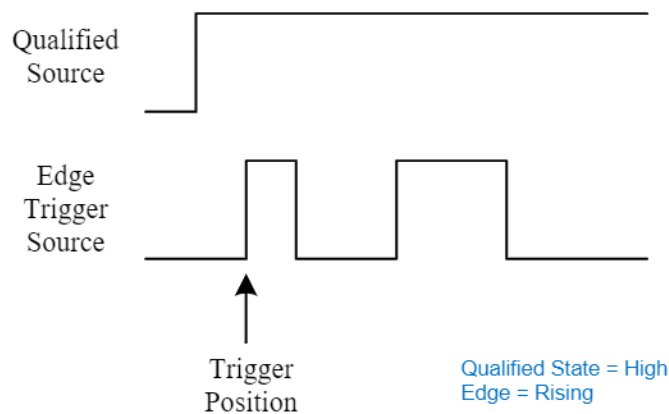

When the type is "Edge", the oscilloscope triggers at the first edge after the specified edge (Rising or

Falling) of the qualified source; when the type is “Edge with Delay”, a time limit condition is available.

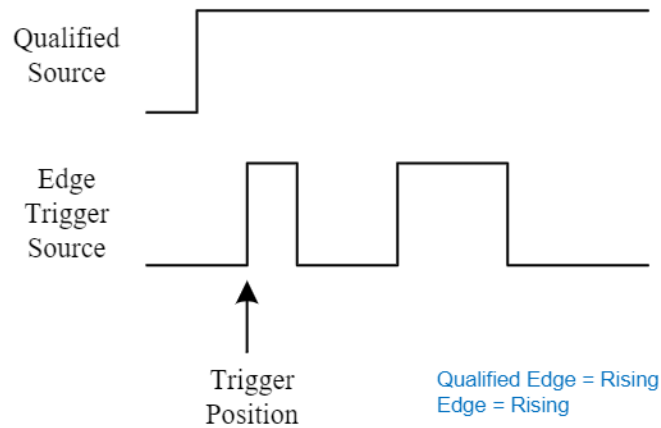

Touch the **Qualified Setting** region to set the qualified source and threshold;

Touch the **Edge Setting** region to set the edge trigger source, threshold, and slope.

16.5.12 Nth Edge Trigger

Nth edge trigger is similar to an edge trigger with conditions. The trigger is satisfied after meeting the user-defined idle time and edge number conditions. As shown in the figure below, when the idle time between the pulse trains is greater than the specified idle time, it is triggered on the third falling edge of the pulse train.



Trigger source, slope (rising, falling), idle time, and edge number can be set in the trigger dialog box.

Holdoff, coupling, and noise reject can be set in the Nth edge trigger, see the sections "Holdoff", "Trigger Coupling" and "Noise Reject" for details.

16.5.13 Delay Trigger

A delay trigger is true when the edge of source B occurs after meeting the set conditions of source A and a user-defined delay time. The setting of source A is similar to that of the pattern trigger and can be used for logical "and" combination of multiple channels.

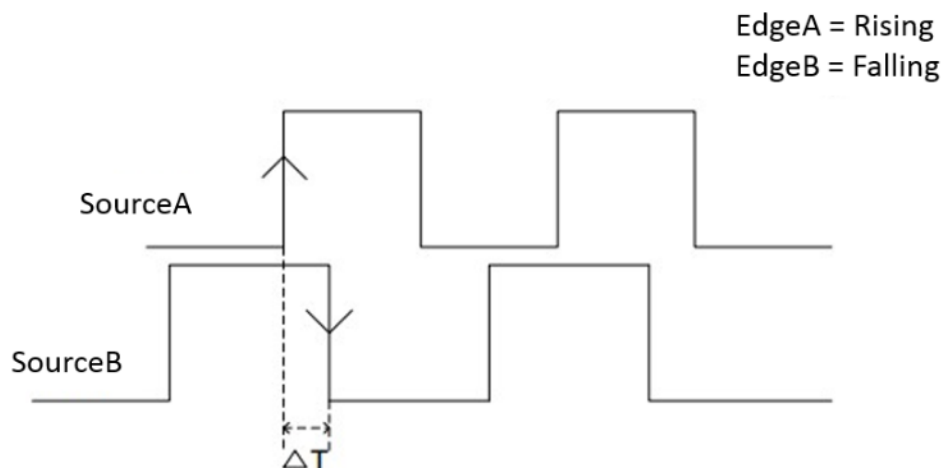

Touch the **SourceB Setting** region to set the edge trigger source, threshold, and slope.
 Touch the **Limit Range** and **Upper/Lower Value** region to set the delay time condition.

16.5.14 Setup/Hold Trigger

Clock source and data source need to be set in the setup/hold trigger setting. The set-up time starts when the data signal crosses the trigger level and ends when the specified clock edge arrives. The holding time starts when the specified clock edge arrives and ends when the data signal crosses the trigger level again (as shown in the figure below). When the set-up time or hold time meets the preset time limit conditions, the oscilloscope will trigger.

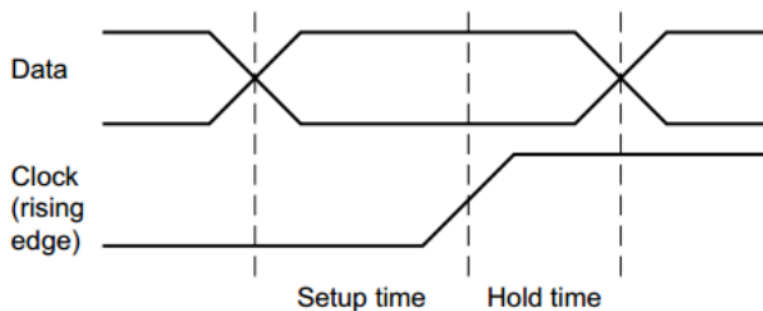

Touch the **CLK Setting** region to set the clock source, threshold, and slope;
 Touch the **Data Setting** region to set the data source, threshold, and state.

16.5.15 Serial Trigger

Refer to chapter "Serial Trigger and Decode" for detailed information.

16.6 Trigger Source

The trigger sources supported by each trigger type are different. See the table below for details:

| Trigger Type | C1~C4 | EXT, EXT/5 | AC Line | D0~D15 |
|--------------|-------|------------|---------|--------|
| Edge | √ | √ | √ | √ |
| Slope | √ | × | × | × |
| Pulse | √ | × | × | √ |
| Video | √ | × | × | × |
| Window | √ | × | × | × |
| Interval | √ | × | × | √ |
| Dropout | √ | × | × | √ |
| Runt | √ | × | × | × |
| Pattern | √ | × | × | √ |
| Serial | √ | × | × | √ |
| Qualified | √ | × | × | √ |
| Nth Edge | √ | × | × | √ |
| Delay | √ | × | × | √ |
| Setup/Hold | √ | × | × | √ |

16.7 Holdoff

Holdoff is an additional condition for triggers and can be used to stabilize the triggering of complex waveforms (such as a pulse series). It can be set to a time or number of events.

Holdoff by Time

Holdoff time is the amount of time that the oscilloscope waits before re-arming the trigger circuitry. The oscilloscope will not trigger until the holdoff time expires.

Use the holdoff to trigger on repetitive waveforms that have multiple edges (or other events) between waveform repetitions. You can also use holdoff to trigger on the first edge of a burst when you know the minimum time between bursts.

For example, to achieve a stable trigger on the repetitive pulses shown in the figure below set the holdoff time (t) to $200\text{ns} < t < 600\text{ns}$.

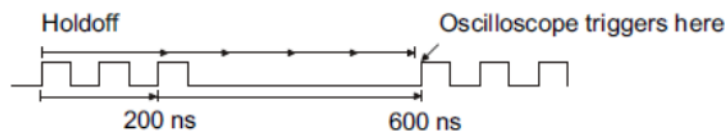

Holdoff by Event

The Holdoff event sets the number of events that the oscilloscope counts before re-arming the trigger circuitry. The oscilloscope will not trigger until the counter that tracks holdoff events reaches the set value. In the following figure, the holdoff event is set to 3, and the signal is triggered on the fourth edge.



Parameter **Start Holdoff On** defines the initial position of holdoff.

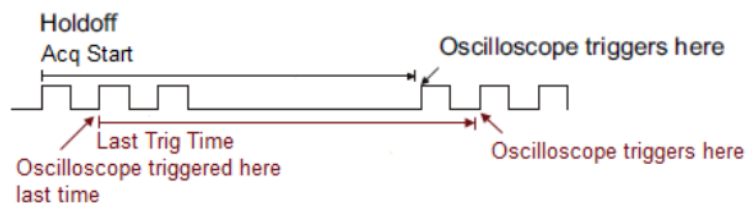

Acq Start -- The initial position of holdoff is the first time point satisfying the trigger condition. In the example above, each holdoff starts from the first rising edge of the pulse sequence.

Last Trig Time --The initial position of holdoff is the time of the last trigger. In the example above, the last trigger position is at the second rising edge of the pulse sequence and the second holdoff starts from that point.

16.8 Trigger Coupling

The coupling setting of a trigger is only valid when the trigger source is C1~C4, EXT, or EXT/5.

- DC: All of the signal's frequency components are coupled to the trigger circuit for high-frequency bursts or where the use of AC coupling would shift the effective trigger level.
- AC: The signal is capacitively coupled. DC levels are rejected. See the datasheet for details of the cut-off frequency.
- HFR: Signals are DC coupled to the trigger circuit and a low-pass filter network attenuates high frequencies (used for triggering on low frequencies). See the datasheet for details of the cut-off frequency.
- LFR: The signal is coupled through a capacitive high-pass filter network, DC is rejected and low frequencies are attenuated. For stable triggering on medium to high-frequency signals. See the datasheet for details of the cut-off frequency.

16.9 Noise Reject

Noise Reject adds additional hysteresis to the trigger circuitry. By increasing the trigger hysteresis, the noise immunity becomes better but the trigger sensitivity degrades.

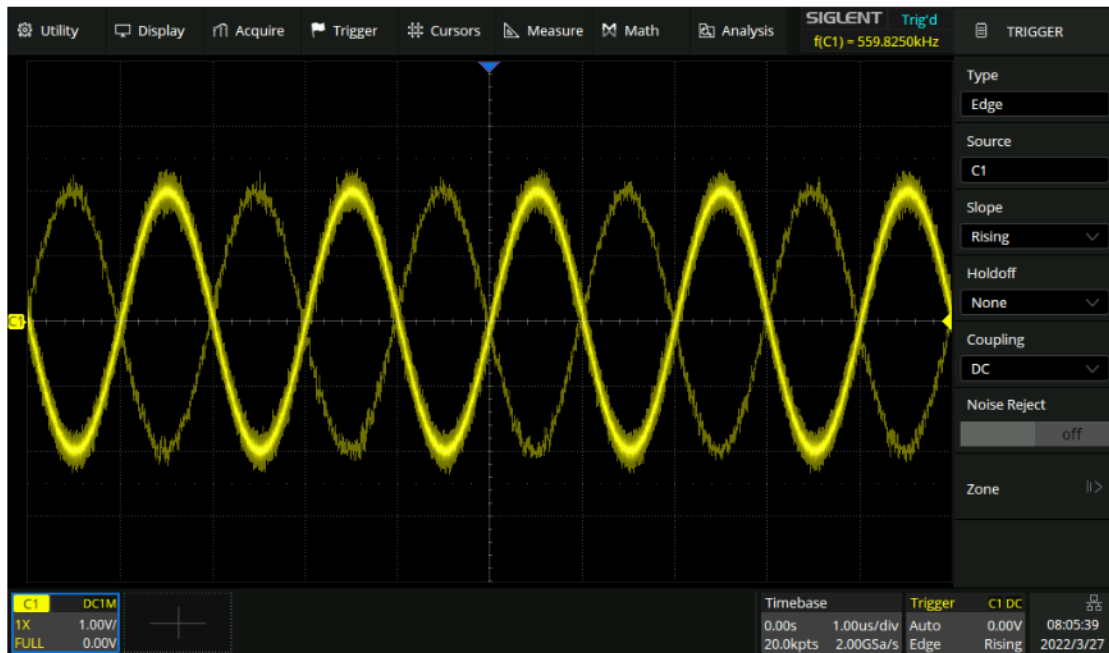

Noise Reject = Off

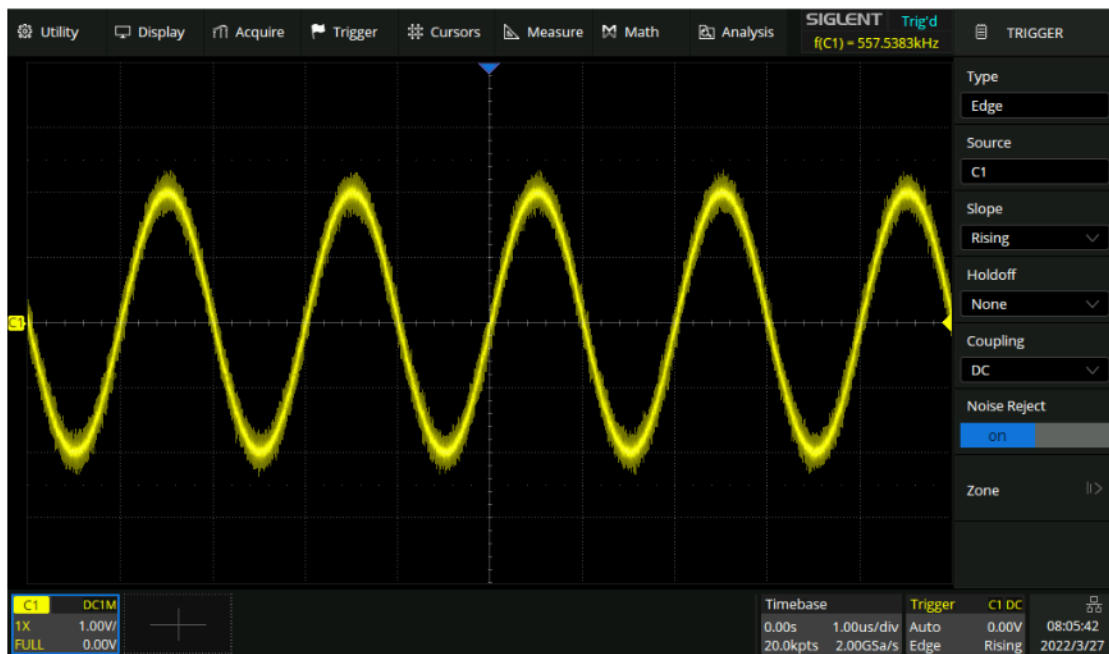

Noise Reject = On

16.10 Zone Trigger

The SDS3000X HD includes a zone trigger to help isolate elusive glitches. There are two user-defined areas: Zone1 and Zone2. Users can set the property of each zone as “intersect” or “not intersect” as an additional condition to further isolate the interesting event quickly. “Intersect” only includes events that occur within the zone. “Not-intersect” events include all events that occur outside of the zone.

Touch **Trigger** > **Zone** to recall zone dialog box:

- A. Turn on or off zone trigger
- B. Select the source: C1~C4
- C. Turn on or off zone1
- D. Set the property of zone1: Intersect or Not intersect
- E. Set the coordinate of zone1. The range is within the waveform area
- F. Turn on or off zone2
- G. Set the property of zone2: Intersect or Not intersect
- H. Set the coordinate of zone2. The range is within the waveform area

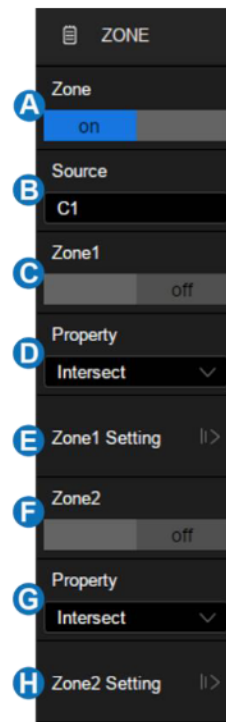

The zones can be created and moved by gestures or by setting **Zone** > **Zone Setting** in the dialog box. The color of the zone’s outline is consistent with the color of the specified source (Channel 1 = Yellow, etc...).

Gesture

When the zone trigger is turned on, touch-and-hold on any position within the waveform area and draw a rectangular box, as shown in the following figure:



When the finger moves out of the screen, a menu pops up for selecting the zone and setting the zone properties:



Once a zone is created, it can be moved by dragging. Just touch and hold the zone box and use a dragging gesture.

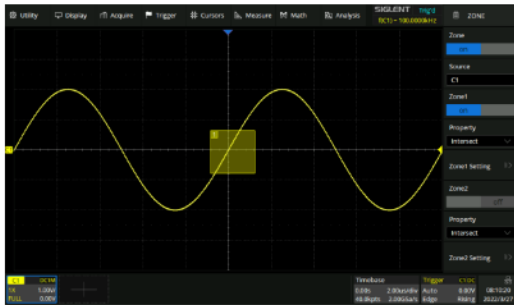

Select C1 as the source, turn on zone1, and set the property as "Intersect"

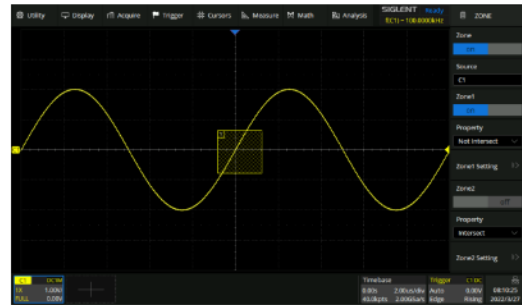

Select C1 as the source, turn on zone1, and set the property as "Not Intersect"

Dialog Box

Touch **Zone** > **Zone Setting** to recall the dialog box.

- A. Set the left border of the zone
- B. Set the right border of the zone
- C. Set the top border of the zone
- D. Set the bottom border of the zone
- E. Return to the previous menu

Touch the regions above to set the value by the universal knob or the virtual keypad.

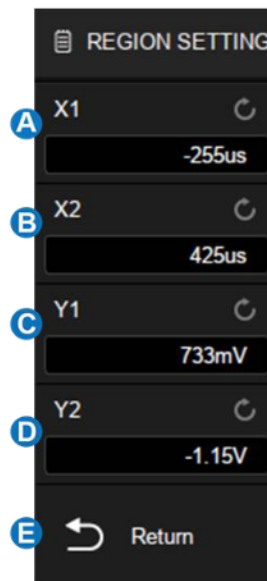

Note: If zone1 and zone2 are both turned on, the result of the "AND" operation in two zones becomes the qualified condition of triggering.

Below is an example in which we want to capture a waveform of bus contention using the SDS3000X HD:

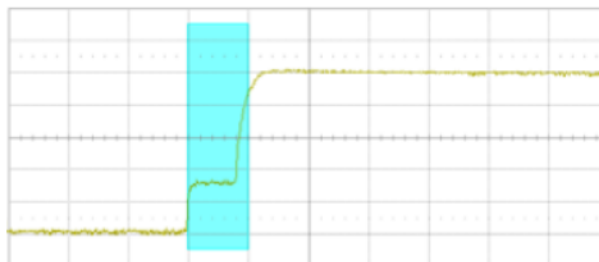

With a simple edge trigger, it is unlikely to trigger consistently on this anomaly. Thanks to the high waveform update rate of the SDS3000X HD, we can confirm there is bus contention happening by

enabling the persistence display, as shown in the figure below:

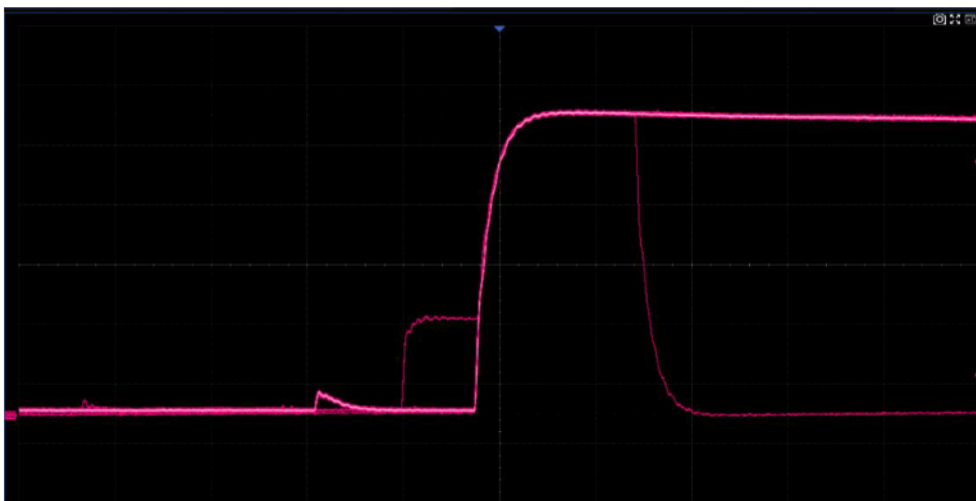

In this case zone trigger is a quick and simple way to capture the waveform. Enable the zone trigger, and draw a box to intersect with the bus contention part, as shown in the figure below:

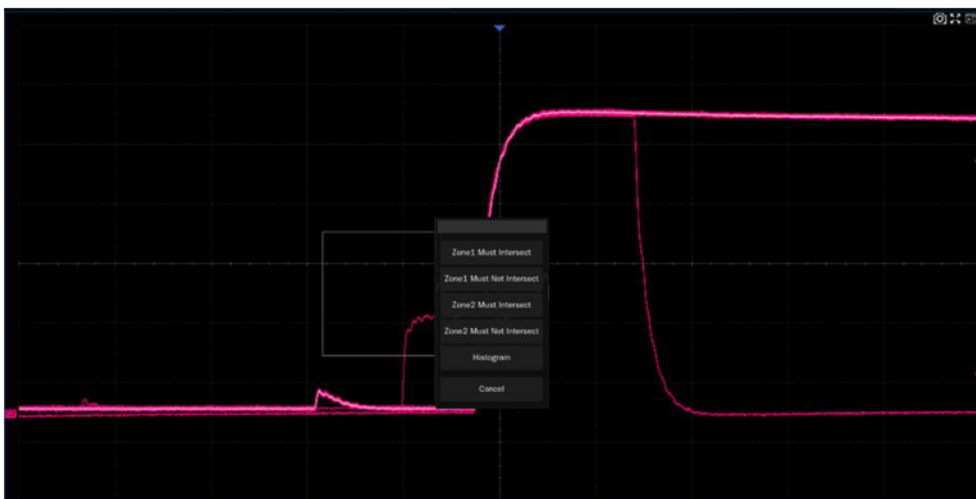

Now, we can accurately capture the exact bus contention waveform:

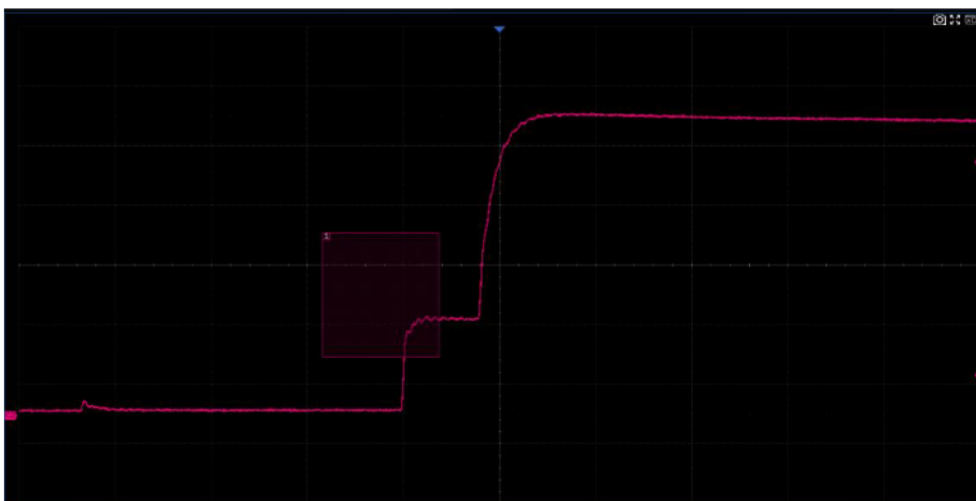

17 Serial Trigger and Decode

17.1 Overview

The SDS3000X HD supports serial bus trigger and decoding on the following serial bus protocols: I2C, SPI, UART, CAN, LIN, FlexRay, CAN FD, I2S, MIL-STD-1553B, SENT, Manchester and ARINC429.

Press the **Setup** button on the front panel or touch the trigger descriptor box, and then select the **Type** as **Serial** in the trigger dialog box to set the serial trigger:

- A. Select the type as **Serial**
- B. Select the serial bus protocol
- C. Set the signal, including the mapping relation between channels and bus signals, and the thresholds
- D. Trigger setting

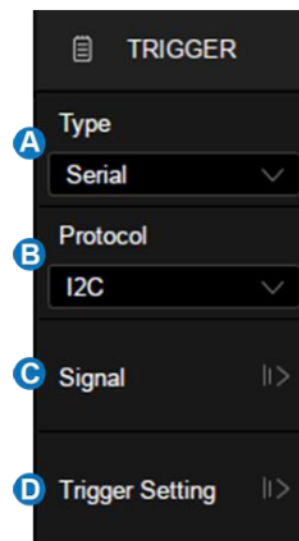

Touch the **Analysis** > **Decode** to turn on the serial decode dialog box:

- A. Set the list of decode result
- B. Select the bus to set, Bus1 and Bus2
- C. Turn on/off the bus
- D. Set the bus display format (Binary, Decimal, Hex, and ASCII)
- E. Select the serial bus protocol
- F. Touch to set the signal, including the mapping relation between channels and bus signals, and the thresholds. This is similar to the signal setting of a serial trigger.
- G. Configure the bus protocol
- H. Synchronize the settings between a serial trigger and decode

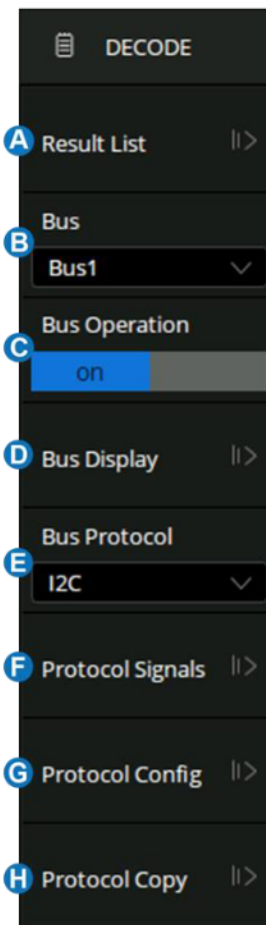

Below are detailed descriptions of the trigger and decode steps for each protocol.

- I2C Trigger and Serial Decode
- SPI Trigger and Serial Decode
- UART Trigger and Serial Decode
- CAN Trigger and Serial Decode
- LIN Trigger and Serial Decode
- FlexRay Trigger and Serial Decode
- CAN FD Trigger and Serial Decode
- I2S Trigger and Serial Decode
- MIL-STD-1553B Trigger and Serial Decode
- SENT Trigger and Serial Decode
- Manchester Serial Decode
- ARINC 429 Trigger and Serial Decode

17.2 I2C Trigger and Serial Decode

This section covers triggering and decoding I2C signals. Please read the following for more details: "I2C Signal Settings", "I2C Trigger" and "I2C Serial Decode".

17.2.1 I2C Signal Settings

Connect the serial data signal (SDA) and the serial clock signal (SCL) to the oscilloscope, set the mapping relation between channels and signals, and then set the threshold level of each signal. The signal settings of decode and trigger are independent. If you want to synchronize the settings between decode and trigger, please perform *Protocol Copy* in the decode dialog box.

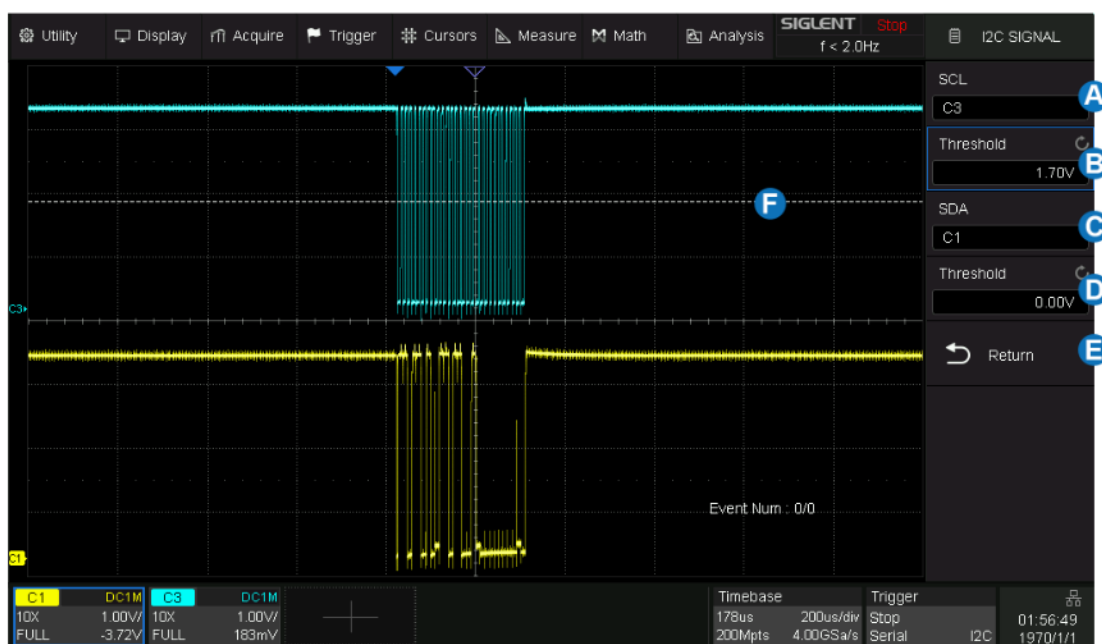

- A. Set the source of SCL. In the example above, SCL is connected to C4.
- B. Set the threshold level of SCL. It is 1.7V for the LVTTTL signal in this example.
- C. Set the source of SDA. In the example above, SDA is connected to C1.
- D. Set the threshold level of the SDA channel.
- E. Return to the previous menu.
- F. Threshold level line. It only appears when adjusting the threshold level.

Copy Setting

Touch the **Protocol Copy** in the decode dialog box to synchronize the settings between the trigger and decode.

- Copy the decode settings to trigger
- Copy the trigger settings to decode
- Return to the previous menu.

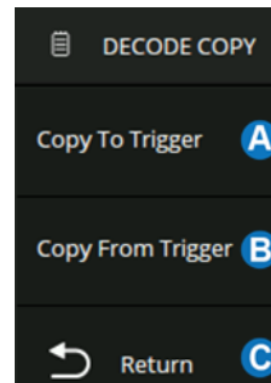

Note: The synchronization is not automatic. If the settings at one place change, a copy operation is necessary to re-synchronize.

17.2.2 I2C Trigger

When the protocol is set to I2C, the following trigger conditions can be set: Start, Stop, Restart, No Ack, EEPROM, or an R/W frame with a specific device address and data value.

Touch **Trigger Setting** in the I2C trigger dialog box to select the trigger condition:

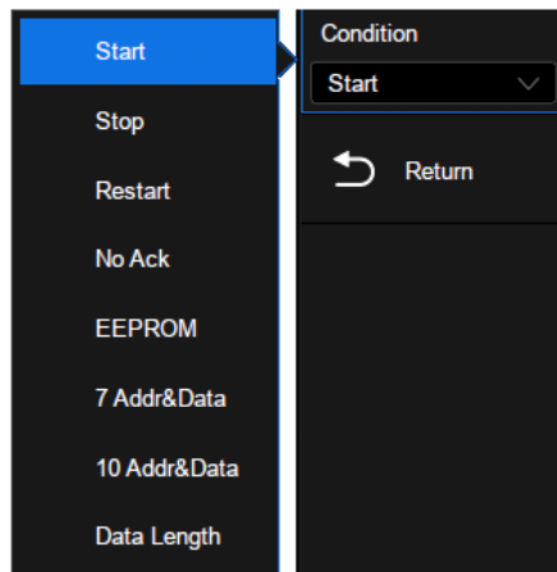

Start -- The oscilloscope will be triggered when the SDA line transitions from high to low while the SCL is high.

Stop -- The oscilloscope will be triggered when the SDA line transitions from low to high while the SCL is high.

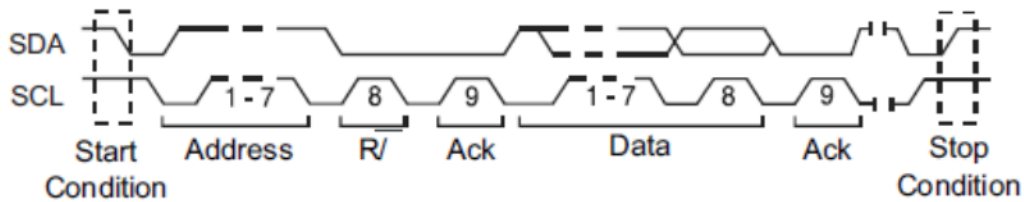

Restart -- The oscilloscope will be triggered when another “Start” occurs before a “Stop”.

No Ack -- The oscilloscope will be triggered when the SDA line is high during any SCL’s ACK bit.

EEPROM -- The trigger searches for EEPROM control byte value 1010xxx on the SDA bus. And there is a Read bit and an ACK bit behind EEPROM. Set the data value and compare type according to **Data1** and **Limit Range** . If EEPROM’s data is greater than (less than, equal to) **Data1** , the oscilloscope will be triggered at the edge of the ACK bit behind the Data byte. The Data byte doesn’t need to follow the EEPROM.

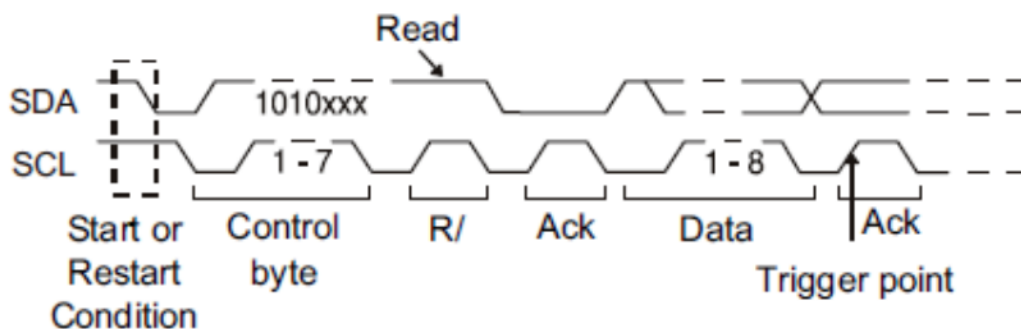
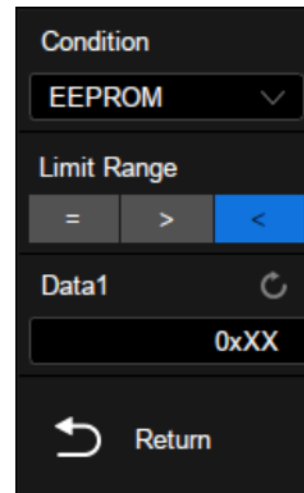

7 Address & Data -- the oscilloscope will be triggered on the read or write frame in 7-bit address mode.

Frame (Start: 7-bit address: R/W: Ack) -- Data1 and Data2 are set to “0xXX”. If all bits match, then trigger on the Ack bit followed by the R/W bit.

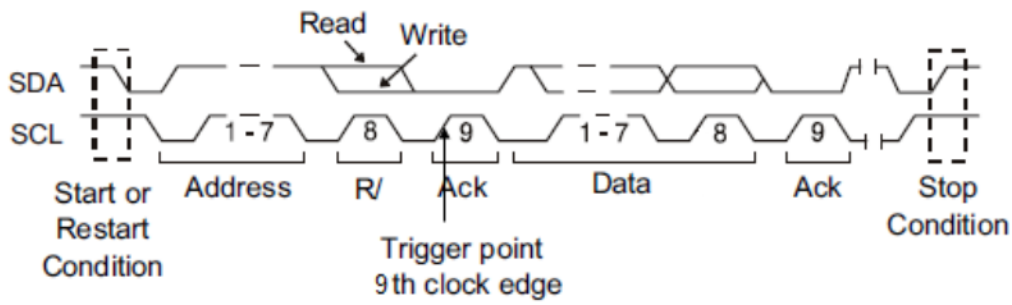

Frame (Start: 7-bit address: R/W: Ack: Data: Ack: Data2) -- If all bits match, then trigger on the Ack bit followed by the Data2.

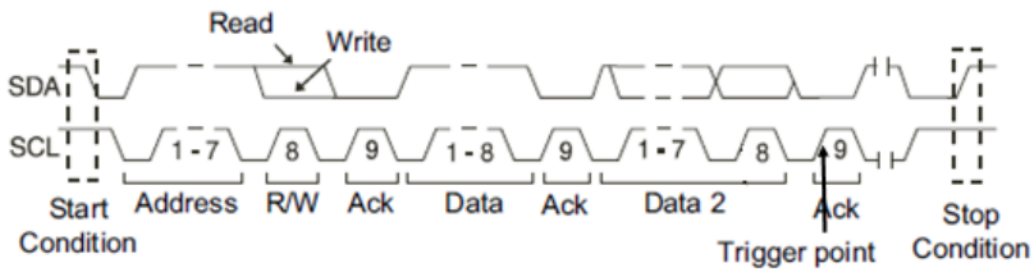

10 Address & Data -- If all bits match, then trigger on the Ack bit followed by the Data.

Frame (Start: Address 1st byte: R/W: Ack: Address 2nd byte: Ack: Data)

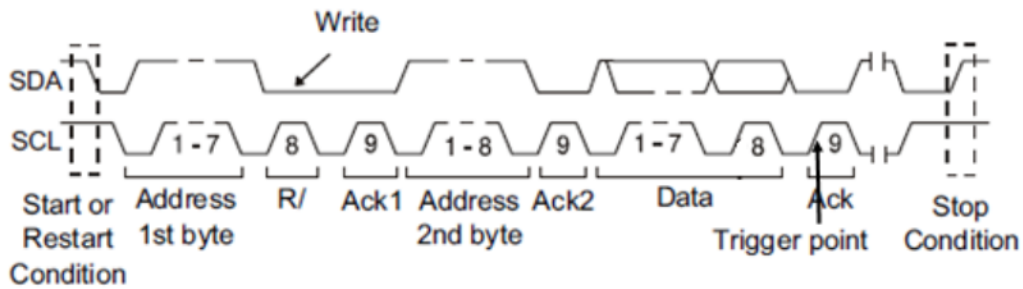

If you set the trigger condition to 7 address & data or 10 address & data:

- **Address** can be selected in the hexadecimal range of 0x00 to 0x7F (7-bit) or 0x3FF (10-bit). If the address is selected as "0xXX (7-bit address)" or "0xXXX (10-bit address)", the address is ignored. It will always trigger on the Ack bit followed by the address.
- **Data1** and **Data2** can be selected in the hexadecimal range of 0x00 to 0xFF. If the data is selected as "0xXX", the data is ignored. It will always trigger on the Ack bit followed by the address.
- **R/W Bit** can be specified as Write, Read, or Don't Care.

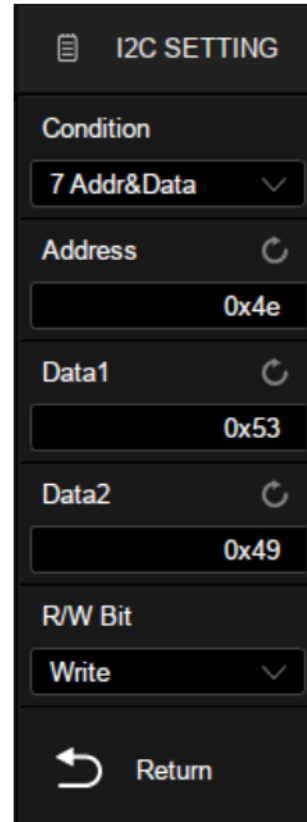

Data Length -- The data length range is 1 to 12 bytes. When the SDA data length is equal to the value of Date Length and address length is the same as the set value, the oscilloscope will be triggered.

- Touch the **Address Length** to select "7-bits" or "10-bits" to match the address of the input signal.
- Touch the **Data Length** and turn the universal knob or virtual keypad to set the data length to match the data length of the input signal.

17.2.3 I2C Serial Decode

The layout of the touch screen display when I2C decode is enabled is as follows:

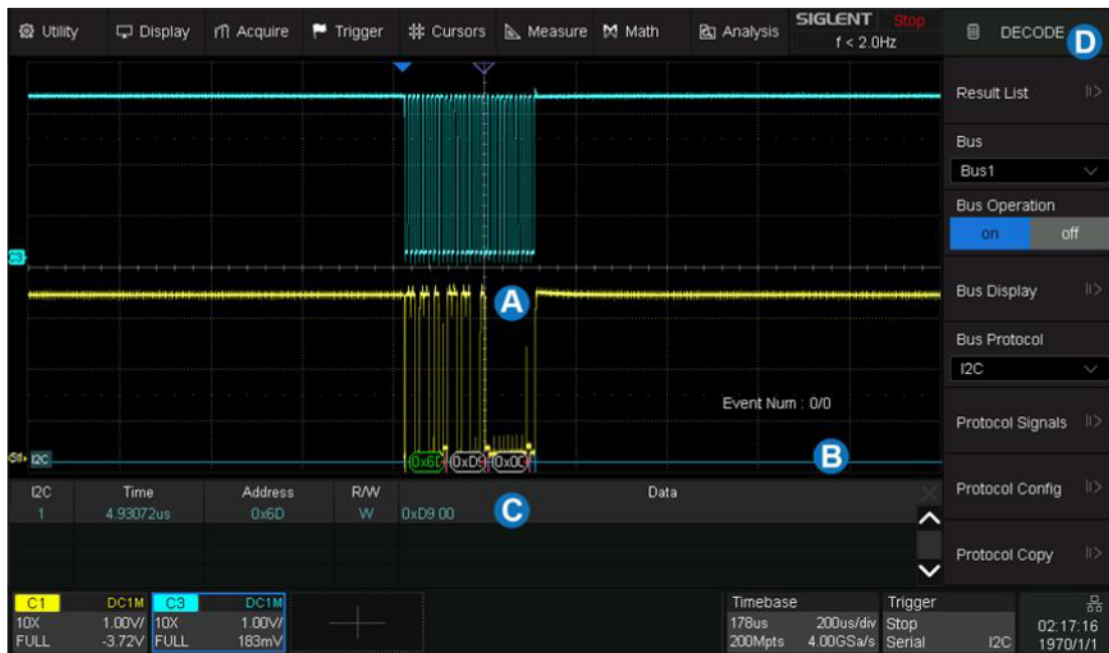

- The waveform display area shows the original waveforms of the bus signals
- The bus display shows the decoding result of the bus. At most two buses can be decoded at the same time. Touch **Bus Operation** of the dialog box to turn on or off the selected bus, and touch **Bus Display** to select the display type of decode result (Binary, Decimal, Hex, or ASCII) and set the bus location on the display
- List display area. The decode result of multiple frames can be displayed in the list, in which each row shows the time label and decode result of a frame. Touch **Result List** to set the parameters of the list.
- Decode dialog box

Bus

- The address value is displayed at the beginning of a frame. The write address is displayed in green and the read address in yellow.
- W/R bit is represented by (W) and (R), followed by the address value.
- The **A** after a data or address byte represents ACK (acknowledgment), and **-A** indicates no acknowledgment.
- The data value is displayed in white.
- A red point at the end of a segment indicates there is not enough space on the display to show the complete content of a frame, and some content is hidden, such as **0x4C**.

17.3 SPI Trigger and Serial Decode

This section covers triggering and decoding SPI signals. Please read the following for more details: "SPI Signal Settings", "SPI Trigger" and "SPI Serial Decode".

17.3.1 SPI Signal Settings

Connect the CLK, MOSI, MISO, and CS signals to the oscilloscope and set the mapping relation between channels and signals. Then set the threshold level of each signal. The process of specifying the source and threshold is similar to "I2C Signal Settings".

CLK

In addition to specifying the source and the threshold level, for the CLK signal, it is also necessary to specify the **Edge Select**.

- Rising–Data latched on the rising edge of the clock.
- Falling–Data latched on the falling edge of the clock.

The user can select the edge according to the actual phase relationship between the clock and the data of the SPI bus. Referring to the following figure, when the falling edge of the clock is aligned with the data, the rising edge is selected to latch the data. When the rising edge of the clock is aligned with the data, the falling edge is selected to latch the data.

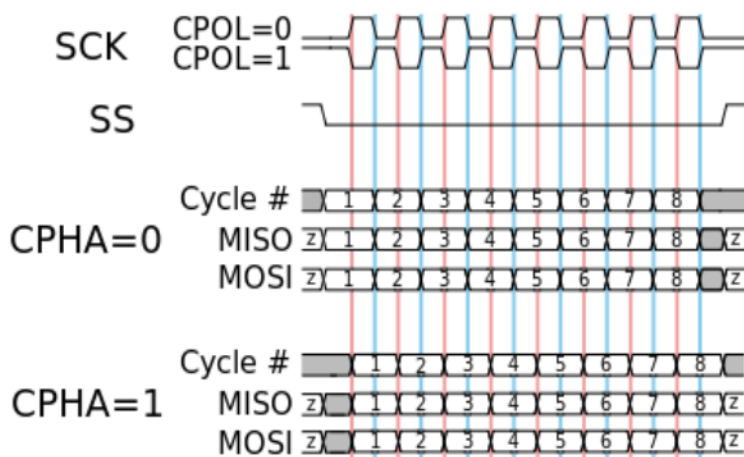

CS

The CS signal should be set to correct **CS Type**, including CS, \sim CS, and Clock Timeout.

- CS -- Active high. The CS signal needs a complete rising edge in the screen to be regarded as active.
- \sim CS -- Active low. The \sim CS signal needs a complete falling edge in the screen to be regarded as active.

- Clock Timeout -- It is not necessary to specify the source and the threshold level for the CS signal. The only parameter for the CS signal is the timeout Limit, which is the minimum time that the clock signal must be held idle before the oscilloscope acquires valid data. This setting is suitable for the case where the CS signal is not connected, or the number of oscilloscope channels is insufficient (such as two-channel oscilloscopes).

The method of copying settings is the same as I2C signal settings. See "I2C Signal Settings" for details.

Example:

Connect the data, CLK, and \sim CS signals of an SPI bus respectively to C1, C2, and C3. Data width = 8-bit, Bit order = MSB, CS polarity = active low, and 12 data bytes are transmitted in one frame.

In the SPI trigger signal menu, set the source and threshold of CLK, MISO, and CS signals, then copy the trigger settings to decoding. Adjust the timebase, so that there is a falling edge on the CS signal shown on the screen:



When the CS type is set to Clock Timeout, turn on Cursor, measure the clock idle time between frames as 150 us, and measure the interval between clock pulses as 1.28 us, then set the timeout to a value between 1.28 us and 150 us. In this example it is set to 5 us:



If the data width is set to be greater than 8 bits (such as 16 bits), measure the clock idle time between 8-bit data packets as 11.28 us, and then set the timeout time to a value between 11.28 and 150 us. In this example, it is set to 20 us:



17.3.2 SPI Trigger

The trigger condition for the SPI trigger is mainly about data. Touch **Trigger Setting** in the dialog box to set data:

- A. Trigger Type: MISO or MOSI
- B. Set the trigger position type. When set to Any, it will trigger on the specified data. When set to Value, it will trigger on the data from the Start Bit
- C. Set the start bit of the data value
- D. Data Length: 4~96 bits when the start bit is 0
- E. Set to trigger on the specified data value. Touch **Data Value** twice, and enter the value by the virtual keypad, or touch **All Same** to set all bits to 0, 1, or ignored ("X")
- F. Set the bit order to MSB or LSB
- G. Return to the previous menu

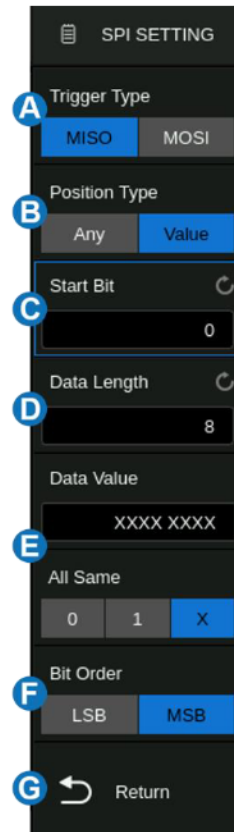

17.3.3 SPI Serial Decode

The configuration of SPI decoding is similar to I2C.

In the **Protocol Config** menu, Data Length (4-32 bit) and Bit Order (LSB or MSB) are configurable.

17.4 UART Trigger and Serial Decode

This section covers triggering and decoding UART signals. Please read the following for more details: "UART Signal Settings", "UART Trigger" and "UART Serial Decode".

17.4.1 UART Signal Settings

Connect the RX and TX signals to the oscilloscope, set the mapping relation between channels and signals, and then set the threshold level of each signal. The process of specifying the source and threshold is similar to "I2C Signal Settings".

In the **Protocol Config** menu of trigger or decode, the following parameters are available:

- A. Touch to select the baud rate: 600,1200, 2400, 4800, 9600, 19200, 38400, 57600, 115200 b/s or Custom
- B. Data Length: 5~8 bit
- C. Parity Check: None, Odd, Even, Mark, or Space. If the data is 9 bits, the 9th bit is treated as Mark parity or Space parity
- D. Select the number of stop bits
- E. Set the idle level
- F. Set the bit order
- G. Return to the previous menu

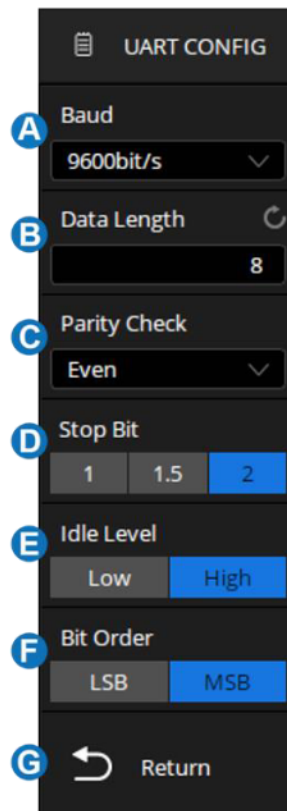

The method of copying settings is the same as I2C signal settings. See "I2C Signal Settings" for details.

17.4.2 UART Trigger

Touch **Trigger Setting** in the dialog box to set the trigger condition:

- A. Source Type: RX or TX
- B. Trigger Condition: Start, Stop, Data or Error
- C. When the "trigger condition" is Data, set the compare type to =, >, <
- D. When the "trigger condition" is Data, set the data value
- E. Return to the previous menu

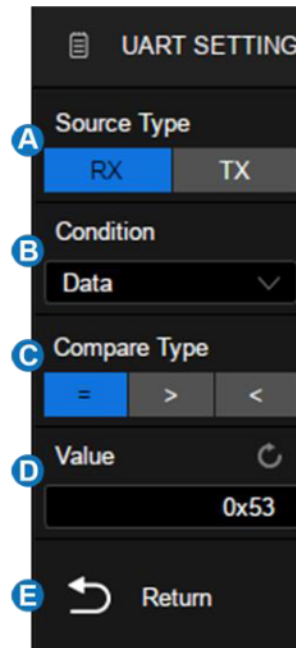

Trigger Condition

- **Start** -- The oscilloscope triggers when the start bit appears on the RX/TX.
- **Stop** -- The oscilloscope triggers when the stop bits appear on the RX/TX. It always triggers on the first stop bit.
- **Data** -- Trigger on data
 - ✓ Touch **Compare Type** to select "=", ">" or "<".
 - ✓ Touch **Value** to set the data value by the universal knob or virtual keypad. The range of data values is 0x00 to 0xff.
- **Error** -- The oscilloscope performs a parity check on the data according to the parity type set by the user, and triggers if the check value is incorrect.

17.4.3 UART Serial Decode

The configuration of UART decoding is similar to that of I2C decoding.

On the bus:

- DATA is displayed in frames and displayed in white.
- Check value errors will cause the associated data words to be displayed in red.
- The red point at the end of a segment indicates there is not enough space on the display to show the complete content of a frame and some content is hidden.

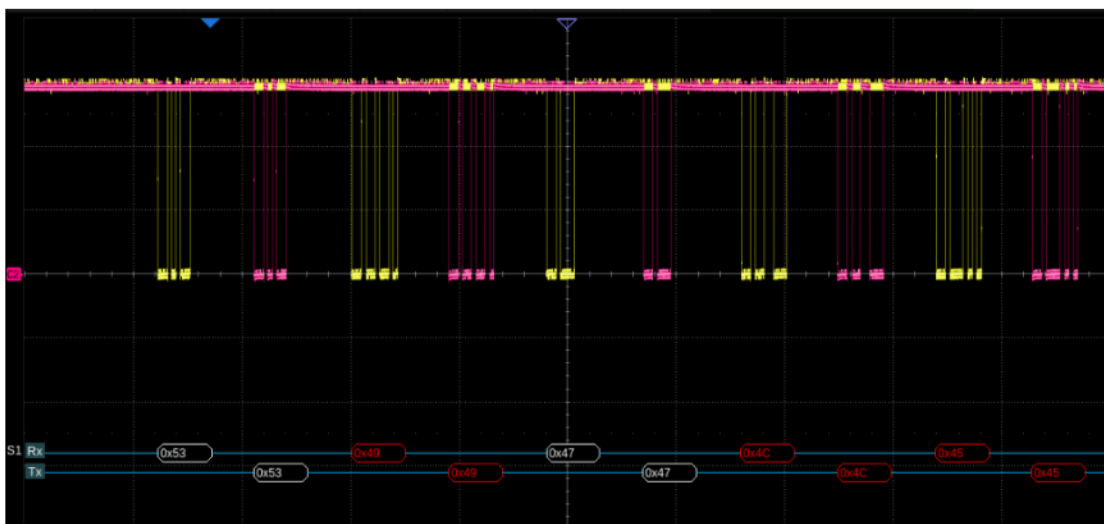

In the list view:

- **Time** -- The horizontal offset of the current data frame head relative to the trigger position.
- **RX** -- Receive data.
- **RX Err** -- Receive error type.
- **TX** -- Send data.
- **Data** -- Send error type.

| UART | Time | RX | RX Err | TX | TX Err |
|------|------------|------|------------|------|------------|
| 1 | -24.2780us | 0x53 | | | |
| 2 | 20.1392us | | | 0x53 | |
| 3 | 65.3218us | 0x49 | Parity Err | | |
| 4 | 109.767us | | | 0x49 | Parity Err |
| 5 | 154.861us | 0x47 | | | |
| 6 | 199.305us | | | 0x47 | |
| 7 | 244.460us | 0x4C | Parity Err | | |

17.5 CAN Trigger and Serial Decode

This section covers triggering and decoding CAN signals. Please read the following for more details: "CAN Signal Settings", "CAN Trigger" and "CAN Serial Decode".

17.5.1 CAN Signal Settings

Connect the CAN_H and CAN_L signals to the oscilloscope set the mapping relation between channels and signals, and then set the threshold level of each signal. The process of specifying the source and threshold is similar to "I2C Signal Settings".

In **Protocol Config** menu of trigger and decode, baud rate can be set to: 5 kb/s, 10 kb/s, 20 kb/s, 50 kb/s, 100 kb/s, 125 kb/s, 250 kb/s, 500 kb/s, 800 kb/s, 1 Mb/s or Custom.

The method of copying settings is the same as I2C signal settings. See "I2C Signal Settings" for details.

17.5.2 CAN Trigger

Touch **Trigger Setting** in the CAN trigger dialog box to set the trigger condition:

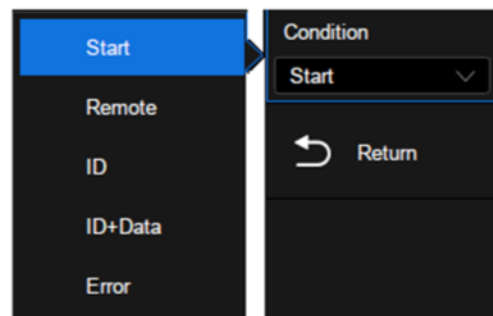

- **Start** -- The oscilloscope triggers at the beginning of the frame.
- **Remote** -- The oscilloscope triggers on a remote frame with a specified ID. ID, ID Bits (11-bit or 29-bit), and Curr ID Byte (1st, 2nd, 3rd, or 4th byte) can be set. Curr ID Byte is used to specify the byte to be adjusted when using the universal knob.
- **ID** -- The oscilloscope triggers on the data frame that matches the specified ID. ID, ID Bits (11-bit or 29-bit), and Curr ID Byte (1st, 2nd, 3rd, or 4th byte) can be set.
- **ID + Data** -- The oscilloscope triggers on the data frame that matches the specified ID and data. ID, ID Bits (11-bit or 29-bit), Curr ID Byte (1st, 2nd, 3rd, or 4th byte), Data1, and Data2 can be set.
- **Error** -- The oscilloscope triggers on the error frame.

17.5.3 CAN Serial Decode

The configuration of CAN decoding is similar to that of I2C decoding.

On the bus:

- ID is displayed in green.
- LEN (data length) is displayed in light yellow.
- DATA are displayed in white.
- CRC is displayed in blue.
- The red point at the end of a segment indicates there is not enough space on the display to show the complete content of a frame and some content is hidden.

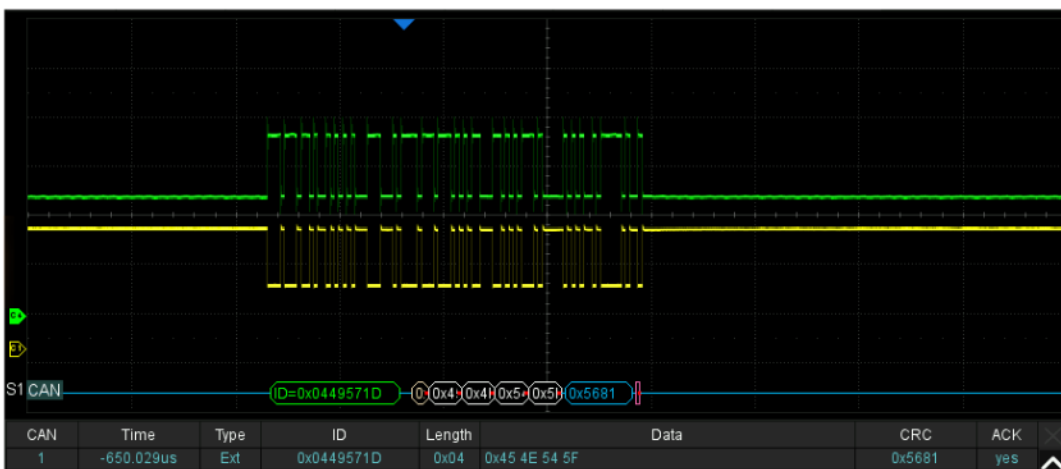

In the list view:

- **Time** -- The horizontal offset of the current data frame head relative to the trigger position.
- **Type** -- Type of the frame. The Data frame is represented by “D” and the remote frame is represented by “R”.
- **ID** -- ID of the frame, 11-bits or 29-bits ID are automatically detected.
- **Length** -- Data length.
- **Data** -- Data values.
- **CRC** -- Cycle redundancy check.
- **Ack** -- Acknowledge bit.

| CAN | Time | Type | ID | Length | Data | CRC | ACK |
|-----|------------|------|------------|--------|---------------------------|--------|-----|
| 1 | -24.1488ms | R | 0x012F30DC | 0 | | 0x4BA5 | yes |
| 2 | -19.9490ms | D | 0x0449571D | 4 | 0x45 4E 54 5F | 0x5681 | yes |
| 3 | -15.1293ms | R | 0x056A7E0C | 3 | | 0x734E | yes |
| 4 | -10.9295ms | D | 0x07819F51 | 8 | 0x53 49 47 4C 45 4E 54 5F | 0x0C9B | yes |
| 5 | -5.44975ms | R | 0x012F30DC | 0 | | 0x4BA5 | yes |
| 6 | -1.24996ms | D | 0x0449571D | 4 | 0x45 4E 54 5F | 0x5681 | yes |
| 7 | 3.56980ms | R | 0x056A7E0C | 3 | | 0x734E | yes |

17.6 LIN Trigger and Serial Decode

This section covers triggering and decoding LIN signals. Please read the following for more details: “LIN Signal Settings”, “LIN Trigger” and “LIN Serial Decode”.

17.6.1 LIN Signal Settings

Connect the LIN signal to the oscilloscope, and then set the threshold level of the signal. The process of specifying the source and threshold is similar to “I2C Signal Settings”.

In **Protocol Config** menu of trigger and decode, baud rate can be set to: 600 b/s, 1200 b/s, 2400 b/s, 4800 b/s, 9600 b/s, 19200 b/s or Custom.

The method of copying settings is the same as I2C signal settings. See “I2C Signal Settings” for details.

17.6.2 LIN Trigger

Touch **Trigger Setting** in the LIN trigger dialog box to set the trigger conditions:

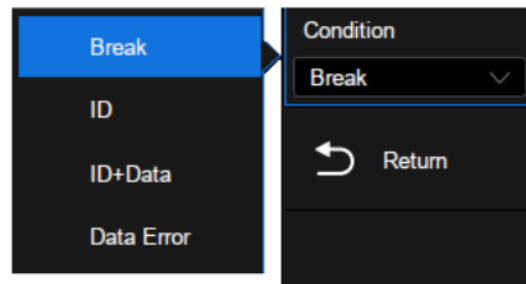

- **Break** -- The oscilloscope triggers at the beginning of the frame.
- **ID** -- The oscilloscope triggers on the frame that matches the specified ID, which ranges from 0x00 to 0x3f.
- **ID & Data** -- The oscilloscope triggers on the frame that matches the specified ID and data. ID, Data1, and Data2 can be set.
- **Data Error** -- The oscilloscope will trigger when a data error happens.

17.6.3 LIN Serial Decode

The configuration of LIN decoding is similar to that of I2C decoding.

On the bus:

- ID is displayed in green
- LEN (data length) and CHK are displayed in blue
- DATA are displayed in white.

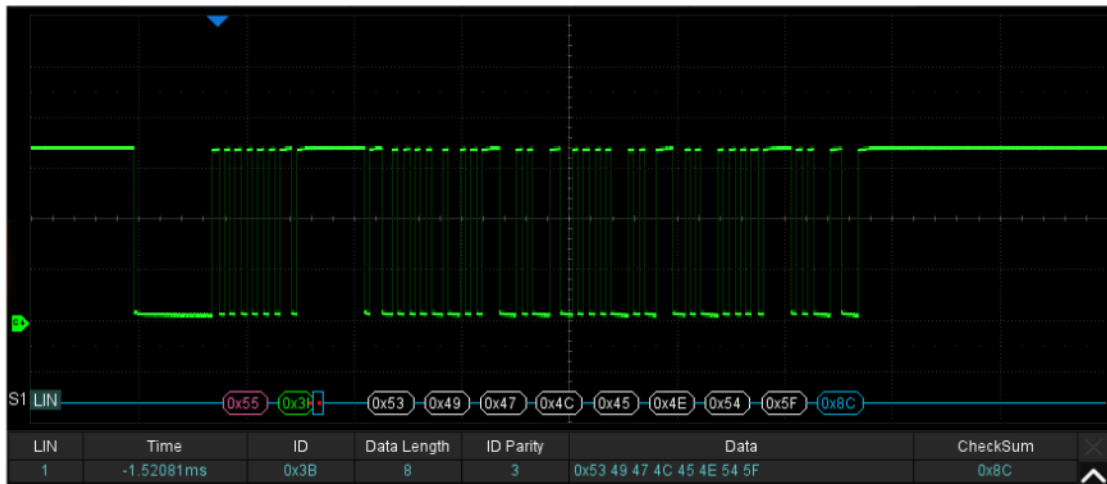

In the list view:

- **Time** -- The horizontal offset of the current data frame head relative to the trigger position.
- **ID** -- ID of the frame.
- **Data length** -- Data length.
- **ID Parity** -- ID parity check.
- **Data** -- Data values.
- **Checksum** -- Data checksum.

| LIN | Time | ID | Data Length | ID Parity | Data | Checksum |
|-----|------------|-----|-------------|-----------|----------|----------|
| 1 | -39.8835ms | 25H | 4 | 00H | ENT_ | 93H |
| 2 | -3.63532ms | 3BH | 8 | 03H | SIGLENT_ | 8CH |
| 3 | 36.7793ms | 06H | 2 | 00H | T_ | 46H |
| 4 | 70.9443ms | 14H | 2 | 00H | T_ | 38H |
| 5 | 105.109ms | 25H | 4 | 00H | ENT_ | 93H |

17.7 FlexRay Trigger and Serial Decode

This section covers triggering and decoding FlexRay signals. Please read the following for more details: "FlexRay Signal Settings", "FlexRay Trigger" and "FlexRay Serial Decode".

17.7.1 FlexRay Signal Settings

Connect the FlexRay signal to the oscilloscope, and then set the threshold level of the signal. The process of specifying the source and threshold is similar to "I2C Signal Settings".

In the **Protocol Config** menu of the trigger and decode, the baud rate can be set to: 2.5 Mb/s, 5.0 Mb/s, 10.0 Mb/s, or Custom.

The method of copying settings is the same as I2C signal settings. See "I2C Signal Settings" for details.

17.7.2 FlexRay Trigger

Touch **Trigger Setting** in the FlexRay trigger dialog box to set the trigger conditions:

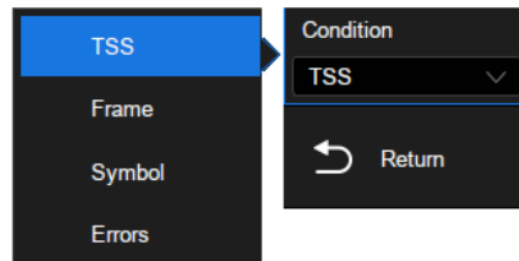

- **TSS** -- The oscilloscope triggers on the transmission start sequence.
- **Frame** -- The oscilloscope triggers on the frame.
 - ✓ Set Frame header indicators: Payload preamble indicator, null frame indicator, sync frame indicator, startup frame indicator.
 - ✓ Touch **ID** to set the frame ID by the universal knob or virtual keypad. The range of ID is 0x000 to 0x7ff.
 - ✓ Touch **Compare Type** to select "=", ">" or "<". When setting the **Compare Type** as "=", the repetition factor is also required.
 - ✓ Touch **Cycle** to set the cycle count by the universal knob or virtual keypad. The range of data values is 0 to 63.
- **Symbol** -- The oscilloscope triggers on CAS/MTS (Conflict Avoidance Symbol/ Media access Test Symbol) or WUS (Wake-up Symbol)
- **Errors** -- The oscilloscope will trigger when a data error happens, including errors on FSS, BSS, FES, Header CRC, and Frame CRC.

17.7.3 FlexRay Serial Decode

The configuration of FlexRay decoding is similar to that of I2C decoding.

On the bus:

- The signatures (CAS/MTS, WUP) are displayed in yellow-green.
- TSS transmission start sequence, displayed in yellow-green. The null frame indicator, the Sync frame indicator, and the Startup frame indicator are displayed in the frame and displayed in pink.
- The ID is displayed in the frame and is displayed in green.
- PL (Valid Data Length) is displayed in frames, in words, in light yellow.
- HCRC (Head Check Code) is displayed in the frame and displayed in blue.
- CYC (cycle) is displayed in the frame and displayed in light yellow.
- D (data) is displayed in the frame and displayed in white.
- FCRC (Data Check Code) is displayed in the frame and displayed in blue.

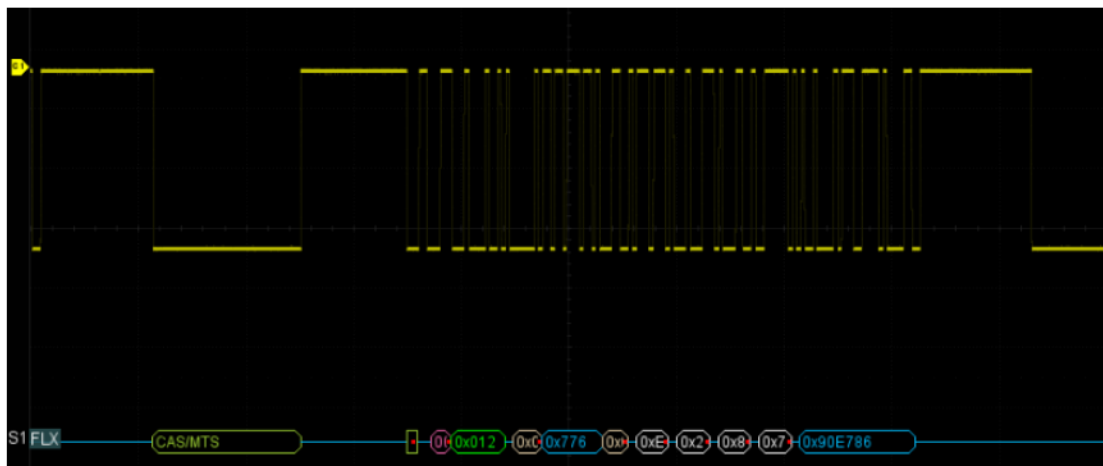

In the list view:

- Time -- The horizontal offset of the current data frame head relative to the trigger position.
- FID -- Frame ID, the symbol occupies a single line of the list.
- PL -- Valid Data Length
- HCRC -- Head Check Code
- CYC -- Cycle count
- Data -- Data values
- FCRC -- Data Check Code

| FLX | Time | FID | PL | HCRC | CYC | Data | FCRC |
|-----|------------|---------|------|-------|------|---------------------|----------|
| 1 | -83.0406us | 0x012 | 0x02 | 0x776 | 0x0C | 0xEE 0x23 0x8C 0x7E | 0x90E786 |
| 2 | -25.0160us | CAS/MTS | 0x02 | 0x776 | 0x0C | 0xEE 0x23 0x8C 0x7E | 0x90E786 |
| 3 | -1.40820us | 0x012 | 0x02 | 0x776 | 0x0C | 0xEE 0x23 0x8C 0x7E | 0x90E786 |
| 4 | 56.6174us | CAS/MTS | 0x02 | 0x776 | 0x0C | 0xEE 0x23 0x8C 0x7E | 0x90E786 |
| 5 | 80.2240us | 0x012 | 0x02 | 0x776 | 0x0C | 0xEE 0x23 0x8C 0x7E | 0x90E786 |

17.8 CAN FD Trigger and Serial Decode

This section covers triggering and decoding CAN FD signals. Please read the following for more details: "CAN FD Signal Settings", "CAN FD Trigger" and "CAN FD Serial Decode".

17.8.1 CAN FD Signal Settings

Connect the CAN FD signal to the oscilloscope, and then set the threshold level of the signal. The process of specifying the source and threshold is similar to "I2C Signal Settings".

In **Protocol Config** menu of trigger and decode, the nominal baud rate can be set to: 10 kb/s, 25 kb/s, 50 kb/s, 100 kb/s, 250 kb/s, 1 Mb/s or Custom. The data baud rate can be set to: 500 kb/s, 1 Mb/s, 2 Mb/s, 5 Mb/s, 8 Mb/s, 10 Mb/s or Custom.

The method of copying settings is the same as I2C signal settings. See "I2C Signal Settings" for details.

17.8.2 CAN FD Trigger

Touch **Trigger Setting** in the CAN FD trigger dialog box to set the trigger conditions:

- Frame Type: Both, CAN, CAN FD
- When the "Frame Type" is CAN FD, turn on or off ISO
- When the "Frame Type" is CAN FD, set the BRS (Bit Rate Switch) to Both, Normal or FD
- Trigger Condition: Start, Remote, ID, ID + Data, Error
- Return to the previous menu

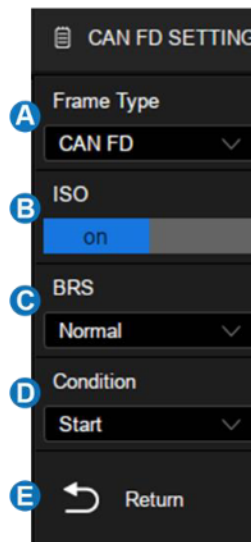

Trigger Condition

- Start** -- The oscilloscope triggers at the beginning of the frame.
- Remote** -- The oscilloscope triggers on a remote frame with a specified ID. ID, ID Bits (11-bit or 29-bit), and Curr ID Byte (1st, 2nd, 3rd, or 4th byte) can be set. Curr ID Byte is used to specify the byte to be adjusted when using the universal knob.
- ID** -- The oscilloscope triggers on the data frame that matches the specified ID. ID, ID Bits (11-bit or 29-bit), and Curr ID Byte (1st, 2nd, 3rd, or 4th byte) can be set.
- ID + Data** -- The oscilloscope triggers on the data frame that matches the specified ID and data. ID, ID Bits (11-bit or 29-bit), Curr ID Byte (1st, 2nd, 3rd, or 4th byte), Data1, and Data2 can be set.

- **Error** -- The oscilloscope triggers on the error frame.
 - ✓ Error Frame
 - ✓ Stuff Bit Error
 - ✓ CRC Mismatch Error: The oscilloscope triggers when the calculated CRC does not match the transmitted CRC.
 - ✓ Stuff Bit Cnt Err: Effective only when ISO is turned on, the oscilloscope triggers when the stuff bit count is incorrect.
 - ✓ Stuff Bit Cnt Par. Err: Effective only when ISO is turned on, the oscilloscope triggers when the polarity of the stuff bit count is incorrect.

17.8.3 CAN FD Serial Decode

The configuration of CAN FD decoding is similar to that of I2C decoding.

On the bus:

- ID is displayed in green.
- BRS (Bit Rate Switch) is displayed in light yellow.
- ESI (Error State Indicator) is displayed in blue.
- L (Data Length) is displayed in light yellow.
- D (Data) is displayed in white.
- CRC is displayed in blue.
- Ack is displayed in pink.
- The red point at the end of a segment indicates there is not enough space on the display to show the complete content of a frame and some content is hidden.

In the list view:

- **Time** -- The horizontal offset of the current data frame head relative to the trigger position.
- **Type** -- Type of the frame. Standard CAN frame is represented by "Std", CAN FD frame is represented by "FD", the extended frame is represented by "Ext" and the remote frame is represented by "RTR".
- **ID** -- Frame ID.
- **Length** -- Data length.
- **Data** -- Data bytes.
- **CRC** -- Cycle redundancy check.
- **Ack** -- Acknowledge bit.

| CAN FD | Time | Type | ID | Length | Data | CRC | ACK |
|--------|------------|--------|------|--------|---------------------------|--------|-----|
| 1 | -190.506us | FD Std | 0x66 | 0x08 | 0x0A 1B 2C 3D 4E 5F 60 71 | 0x9ADA | yes |
| 2 | -95.5054us | FD Std | 0x66 | 0x08 | 0x0A 1B 2C 3D 4E 5F 60 71 | 0x9ADA | yes |
| 3 | -505.600ns | FD Std | 0x66 | 0x08 | 0x0A 1B 2C 3D 4E 5F 60 71 | 0x9ADA | yes |
| 4 | 94.4942us | FD Std | 0x66 | 0x08 | 0x0A 1B 2C 3D 4E 5F 60 71 | 0x9ADA | yes |
| 5 | 189.496us | FD Std | 0x66 | 0x08 | 0x0A 1B 2C 3D 4E 5F 60 71 | 0x9ADA | yes |

17.9 I2S Trigger and Serial Decode

This section covers triggering and decoding I2S signals. Please read the following for more details: "I2S Signal Settings", "I2S Trigger" and "I2S Serial Decode".

17.9.1 I2S Signal Settings

Connect the WS, BCLK, and Data signals to the oscilloscope, set the mapping relation between channels and signals, and then set the threshold level of each signal. The process of specifying the source and threshold is similar to "I2C Signal Settings"

BCLK

In addition to specifying the source and the threshold level, BCLK signals also require the specification of the **Edge Select** .

Rising– Data latched on the rising edge of the clock.

Falling– Data latched on the falling edge of the clock.

WS

In addition to specifying the source and the threshold level, WS signals also require the specification of the **Left CH** .

Low -- Select the left channel when WS is low and the right channel when WS is high.

High -- Select the right channel when WS is low and the left channel when WS is high.

The method of copying settings is the same as I2C signal settings. See "I2C Signal Settings" for details.

17.9.2 I2S Trigger

Touch **Trigger Setting** in the I2S trigger dialog box to set the trigger conditions:

- A. Audio Variant: Audio-I2S, Audio-LJ, Audio-RJ
- B. Trigger Condition: Data, Mute, Clip, Glitch, Rising Edge, Falling Edge
- C. Channel: Set the channel to trigger, Left or Right
- D. Set the bit order to MSB or LSB
- E. Channel Bits: Specify the receiver word length. The length should be greater than or equal to the "Start bit+Data bits"
- F. Start Bit: The start bit of data, ranging from 0 to 31
- G. Data Bits: Specify the number of bits per channel, the range is from 1 to 32 bits
- H. When the "Trigger Condition" is Data, set the compare type to =, >, <
- I. When the "Trigger Condition" is Data, set the data value
- J. Return to the previous menu

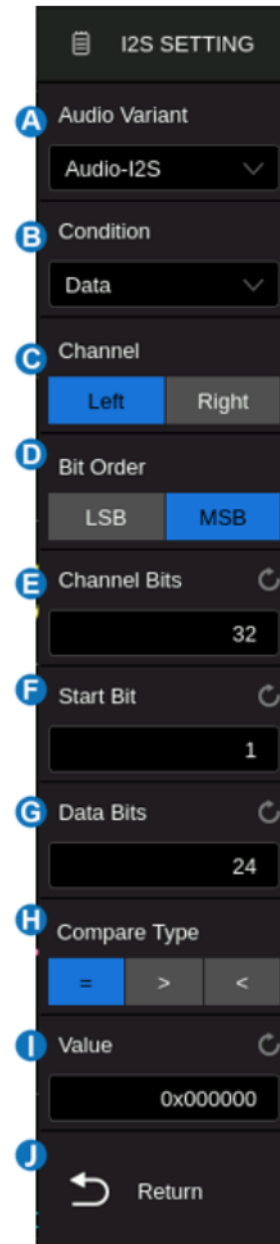

Trigger Condition

- **Data** -- Trigger on data.
 - ✓ Touch **Compare Type** to select "=", ">" or "<".
 - ✓ Touch **Value** to set the data value by the universal knob or virtual keypad. The range of data value is related to the number of **Data Bits**.
- **Mute** -- Trigger on the mute signal. Mute signal: Volume is less than the set value and duration reaches the set value.
 - ✓ Touch **MNF** to set the mute threshold by the universal knob or virtual keypad. The range of values is related to the number of **Data Bits**.

- ✓ Touch **Duration** to set the value by the universal knob or virtual keypad. The range is 1-64 frames.
- **Clip** -- Trigger on the clipped signal. Clip signal: Volume is greater than the set value and duration reaches the set value.
 - ✓ Touch **Clip Level** to set the clip threshold by the universal knob or virtual keypad. The range of values is related to the number of **Data Bits**.
 - ✓ Touch **Duration** to set the value by the universal knob or virtual keypad. The range is 1-64 frames.
- **Glitch** -- Trigger on glitches within the audio signal.
 - ✓ Touch **Threshold** to set the threshold by the universal knob or virtual keypad. The range of values is related to the number of **Data Bits**.
- **Rising Edge** -- Trigger on signals greater than the **Threshold** setting value.
 - ✓ Touch **Threshold** to set the threshold by the universal knob or virtual keypad. The range of values is related to the number of **Data Bits**.
- **Falling Edge** -- Trigger on signals less than the **Threshold** setting value.
 - ✓ Touch **Threshold** to set the threshold by the universal knob or virtual keypad. The range of values is related to the number of **Data Bits**.

17.9.3 I2S Serial Decode

The configuration of I2S decoding is similar to that of I2C decoding.

In the list view:

- **Time** -- The horizontal offset of the current data frame head relative to the trigger position.
- **Type** -- Channel type, the left channel is represented by "Left CH" and the right channel is represented by "Right CH".
- **Data** -- Data bytes
- **Error** -- Error

| I2S | Time | Type | Data | Error |
|-----|------------|----------|------|-------|
| 0 | -600.034us | Right CH | 0x01 | |
| 1 | -100.006us | Left CH | 0x03 | |
| 2 | 399.977us | Right CH | 0x01 | |
| 3 | 899.996us | Left CH | 0x01 | |

17.10 MIL-STD-1553B Trigger and Serial Decode

This section covers triggering and decoding MIL-Standard 1553B signals. Please read the following for more details: "MIL-STD-1553B Signal Settings" and "MIL-STD-1553B Serial Decode".

17.10.1 MIL-STD-1553B Signal Settings

Connect the MIL-STD-1553B signal to the oscilloscope, set the mapping relation between channels and signals, and then set the threshold level of each signal. The process of specifying the source and threshold is similar to "I2C Signal Settings"

17.10.2 MIL-STD-1553B Serial Trigger

When the oscilloscope is set to capture MIL-STD-1553B signals, it can be triggered on Transfer, Word, Error, or triggered on frames that meet the specified message sending interval and response time.

Click **Trigger Setting** in the dialog box to set the trigger conditions:

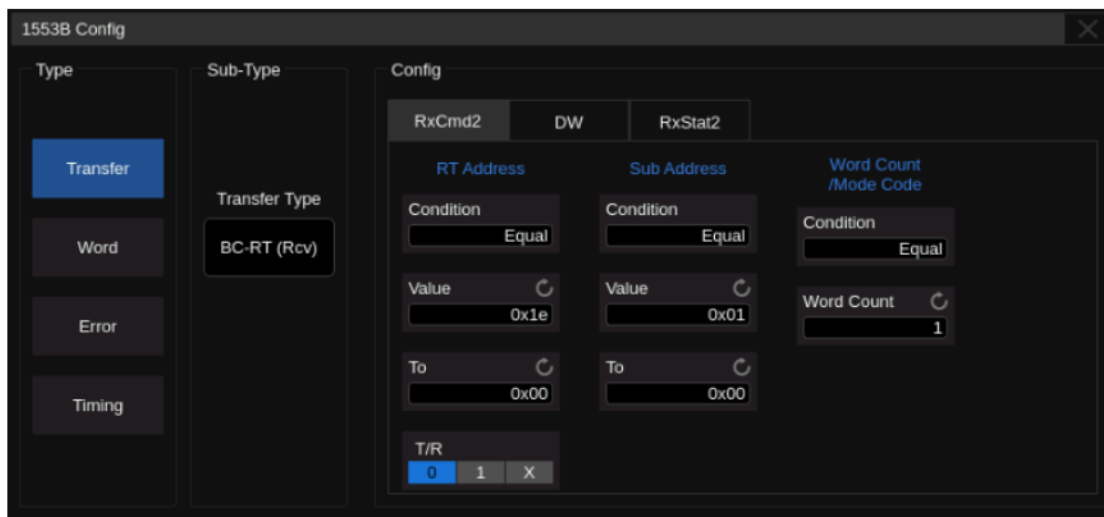

Trigger on Transfer:

- **All** -- Trigger at the end of the Sync pulse of any word.
- **BC-RT (Rcv)** -- Trigger on the specified transmission messages from bus controller to remote terminal. RxCmd + Word Count + DW, RxStat can be specified, and the response time should be less than 14us.
- **RT-BC (Xmit)** -- Trigger on the specified transmission messages from remote terminal to bus controller. TxCmd + Word Count, TxStat+ DW can be specified, and the response time should be less than 14us.
- **RT-RT** -- Trigger on the specified transmission messages from remote terminal to remote terminal. RxCmd + Word Count, TxCmd + Word Count, TxStat + DW, RxStat can be specified, and the response time should be less than 14us.

- **Mode Command** -- Trigger on the specified mode command without DW. TxCmd + Mode Code, TxStat can be specified, and the response time should be less than 14us.
- **Mode Command_Data (Xmit)** -- Trigger on the specified mode command (transmit) with DW. TxCmd + Mode Code, TxStat + DW can be specified, and the response time should be less than 14us.
- **Mode Command_Data (Rcv)** -- Trigger on the specified mode command (receive) with DW. RxCmd + Mode Code + DW, RxStat can be specified, and the response time should be less than 14us.
- **BC-RT (S) (B'cast)** -- Trigger on the specified broadcast transmission messages from bus controller to each remote terminal. Rxcmd (The remote terminal address is 11111) + Word Count + DW can be specified.
- **RT-RT (S) (B'cast)** -- Trigger on the specified broadcast transmission messages from remote terminal to each remote terminal. RxCmd (The remote terminal address is 11111), TxCmd, TxStat + DW can be specified.
- **Mod Command (B'cast)** -- Trigger on the specified broadcast mode command without DW. TxCmd (The remote terminal address is 11111) + Mode Code can be specified.
- **Mod Command_Data (B'cast)** -- Trigger on the specified broadcast mode command with DW. TxCmd (The remote terminal address is 11111) + Mode Code + DW can be specified.

Trigger on Word:

- **All** -- Trigger at the end of the Sync pulse of any word.
- **Command** -- Trigger on the specified Cmd, and RT Address, T/R, Sub Address, Word Count/Mode Code can be specified.
- **Data** -- Trigger on the specified DW.
- **Status** -- Trigger on the specified status word, and RT Address, Error, Inst, SRQ, Bcast Rcvd, Busy, Sub Syst, Dyn Bus, and Term Flag can be specified.

Trigger on Error:

- **Invalid Sync** -- The oscilloscope triggers when an invalid Sync pulse is found. If the high and low level of sync pulse are less than 1.5 bit, it is considered invalid, with a tolerance of 10%.
- **Manchester Error** -- The oscilloscope triggers when a manchester code error is detected.
- **Idle Error** -- The oscilloscope triggers when the word length is incorrect. A word length less than 20 bits is considered an error.
- **Parity Error** -- The oscilloscope triggers when parity error occurs.
- **Bad Word Count** -- The oscilloscope triggers when the Word Count does not meet the definition of command word.
- **Address Mismatch** -- The oscilloscope triggers when the remote terminal address mismatch between status word and command word.

- **Non Contig. Data** -- The oscilloscope triggers when there is a gap between DW.
- **Sync Error** -- The oscilloscope triggers when the message format is not satisfied. When a command word or status word is expected to appear during message transmission, but a data word appears, it is considered an error.

Trigger on Timing:

- **Response Time** -- Trigger on the status word that meets the response time requirement. The response time range is [4us, 12us].
- **Inter Message Gap** -- Trigger on the messages that meet the message interval requirement. The minimum message interval is 4us.

17.10.3 MIL-STD-1553B Serial Decode

The configuration of MIL-STD-1553B decoding is similar to that of I2C decoding.

On the bus:

- C/S the Command/Status word is displayed in green.
- RTA the RT address is displayed in the frame and displayed in light yellow.
- C/S Data is displayed in the frame and is displayed in white.
- The data word is displayed in yellow and the data is displayed in the frame and displayed in white.
- The Check Code is displayed in the frame and displayed in blue.

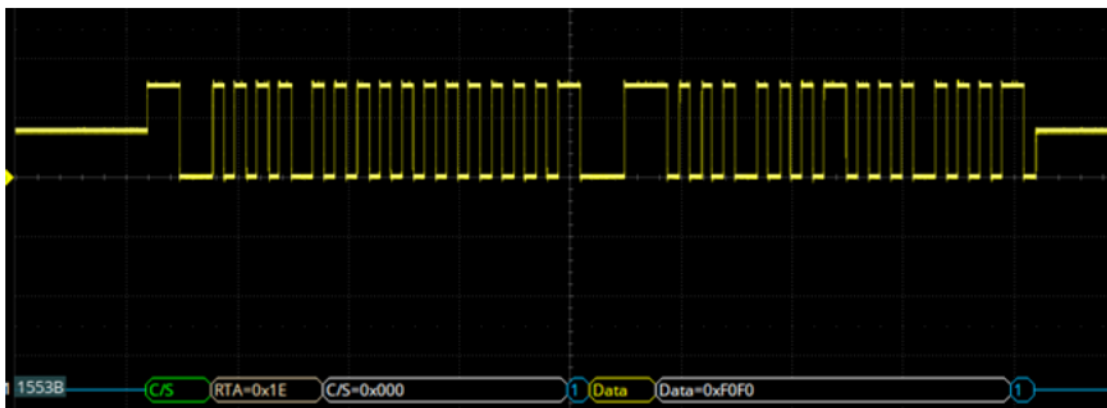

In the decoding list view:

- **Time** -- The horizontal offset of the current data frame head relative to the trigger position.
- **RTA** -- The RT address
- **Type** -- Type of the word
- **Data** -- Data values
- **Error** -- Error type

| 1553B | Time | RTA | Type | Data | Error |
|-------|------------|-----|------------|--------|--------|
| 1 | -2.99040us | 0x1 | Cmd/Status | 0x631 | |
| 2 | 27.0088us | 0x1 | Cmd/Status | 0x0 | Parity |
| 3 | 47.0402us | | Data | 0x8888 | |

17.11 SENT Trigger and Serial Decode

This section covers triggering and decoding SENT signals. Please read the following for more details: "SENT Signal Settings", "SENT Trigger" and "SENT Serial Decode".

17.11.1 SENT Signal Settings

Connect the SENT signal to the oscilloscope, set the mapping relation between channels and signals, and then set the threshold level of each signal. The process of specifying the source and threshold is similar to "I2C Signal Settings"

In the **Protocol Config** menu of trigger or decode, the following parameters are available:

- A. Touch to specify the nominal clock period (tick) time
- B. Set the percent tolerance to determine whether the sync pulse is valid for decoding the data
- C. Set the number of nibbles in a Fast Channel Message
- D. Set the CRC format that will be used in calculating the correctness of the CRCs. The New CRC selection uses the 2010 CRC format. If "NEW" is not selected, the CRC will use the 2008 format. Enhanced Serial Message CRCs are always calculated using the 2010 format, but for the Fast Channel Messages, and for Short Serial Message CRCs, the chosen setting is used
- E. Specify whether there is a pause pulse between Fast Channel Messages
- F. Return to the previous menu

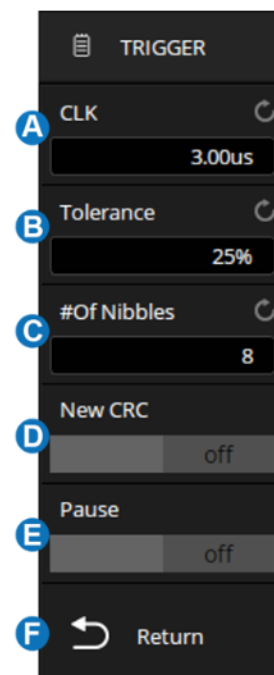

17.11.2 SENT Trigger

When the protocol is set to SENT, the following trigger conditions can be set: Start, Slow Channel, Fast Channel, and Error.

Touch **Trigger Setting** in the SENT trigger dialog box to select the trigger condition:

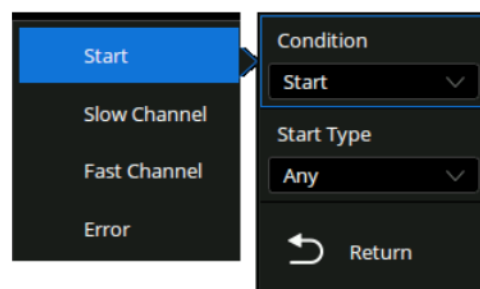

Start -- The oscilloscope will be triggered at the start of the message (after 56 synchronization ticks). You can select the type of message: Fast Channel Message, Slow Channel Message, or any.

Fast Channel -- The oscilloscope will be triggered on a Fast Channel Message when the Status & Communication nibble and the data nibbles match the specified values.

- **State** can be selected in the hexadecimal range of 0x0 to 0xF. If the value is selected as "0xX", the state is ignored.
- **Compare Type** can be specified as Equal, Not Equal, Less than, Less or Equal, Greater than, Greater or Equal, in Range of, out of Range.
- **At Pos** determines the start position of the trigger data. If selected as Value, you need to set **Nibble Pos** in the decimal range of 0 to 5. If selected as Don't care, the oscilloscope will be triggered at the first data which matches the specified condition.
- **Nibble Len** can be selected in the decimal range of 1 to 6. It is associated with the **Nibble Pos**.
- **Data** can be selected in hex. The range is associated with the **Nibble Pos**. If the data is selected as "0xXX", the data is ignored.

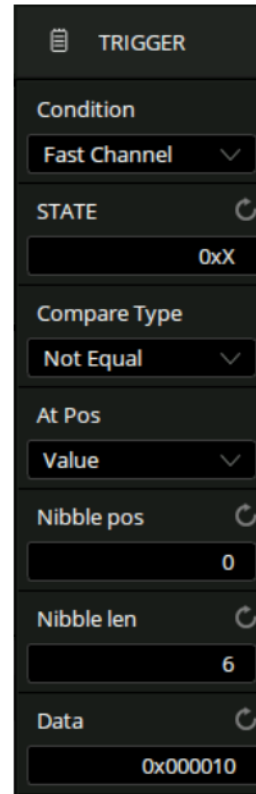

Slow Channel -- the oscilloscope will be triggered on a Slow Channel Message.

Frame (short serial message) -- The 16-bit message consists of a 4-bit Message ID nibble, 2 nibbles (1 byte) of data, and a CRC checksum nibble. If ID and data match, then trigger on the end of CRC bit.

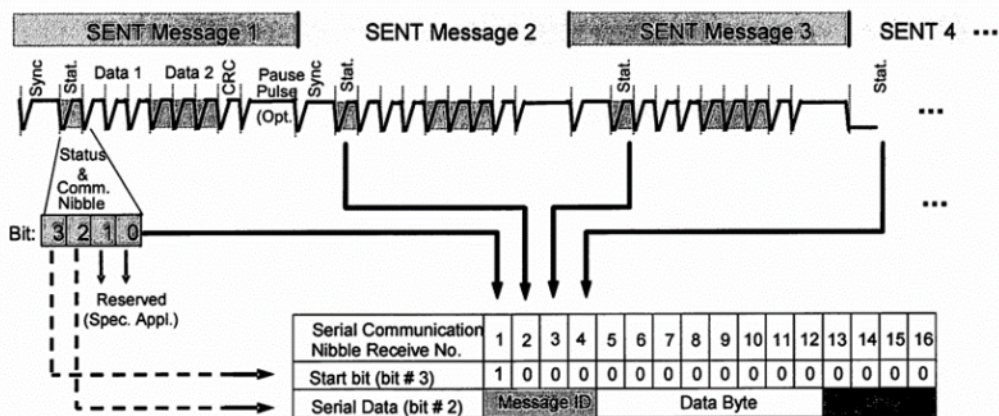

One serial message is composed of 16 SENT consecutive error-free messages.

The serial message frame contains 21 bits of payload data. Two different configurations can be chosen determined by the configuration bit (serial data bit #3, serial communication nibble No. 8):

Frame (enhanced serial message with 4bits ID) -- 16-bit data and 4-bit message ID, the configuration bit is 1.

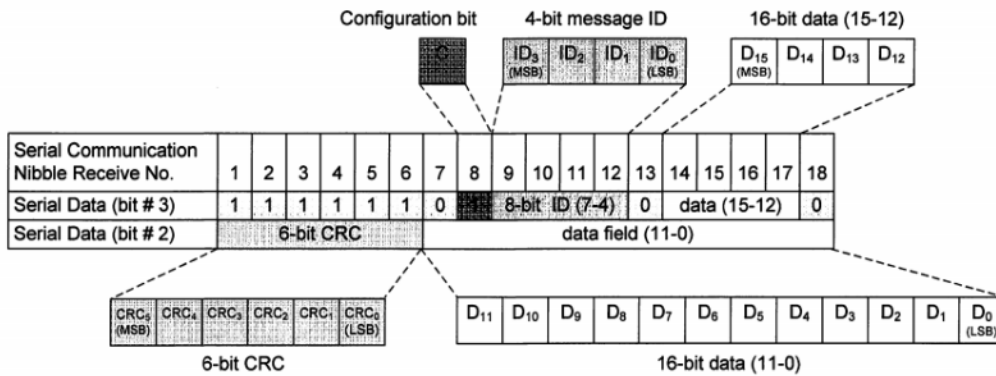

Frame (enhanced serial message with 8bits ID) -- 12-bit data and 8-bit message ID, the configuration bit is 0.

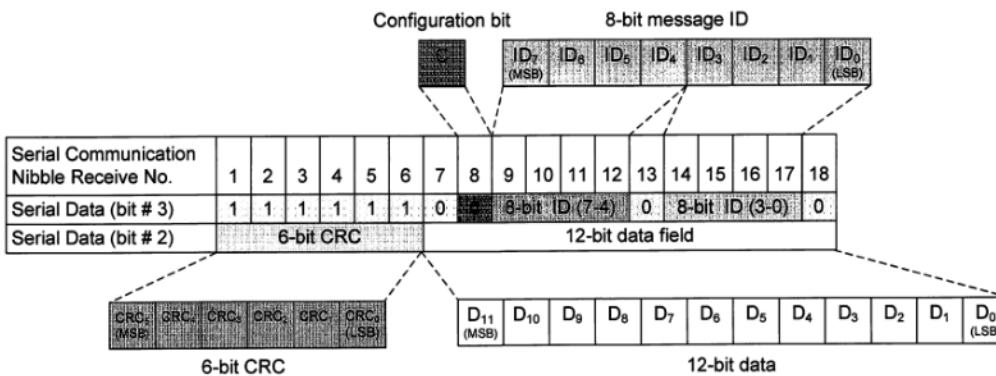

If you set the trigger condition to Slow Channel:

- **ID** can be selected in the hexadecimal range of 0x0 to 0xF (short serial / enhanced serial with 4 bits ID) or 0x00 to 0xFF (enhanced serial with 8 bits ID) . If it is selected as "0xXX", the ID is ignored.
- **Compare Type** can be specified as Equal, Not Equal, Less than, Less or Equal, Greater than, Greater or Equal, in Range of, out of Range.
- **Data** can be selected in the hexadecimal range of 0x00 to 0xFF (short serial) or 0x0000 to 0xFFFF (enhanced serial with 4 bits ID) or 0x000 to 0Xfff(enhanced serial with 8 bits ID). If it is selected as "0xXX", the data is ignored.

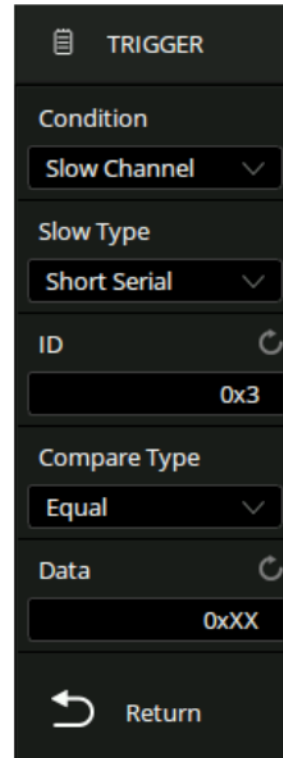

Error -- the oscilloscope triggers on the error frame. Errors include Successive Sync Pulses Error, Pulse Period Error, Fast Channel CRC Error, Slow Channel CRC Error, All CRC Errors.

- Successive Sync Pulses Error: Triggers on a sync pulse whose width varies from the previous sync pulse's width by greater than 1/64 (1.5625%, as defined in the SENT specification).
- Pulse Period Error: Triggers if a nibble is either too wide or too narrow (for example, data nibble < 12 (11.5) or > 27 (27.5) ticks wide). Sync, S&C, data, or checksum pulse periods are checked.
- Fast Channel CRC Error: Triggers on any Fast Channel Message CRC error.
- Slow Channel CRC Error: Triggers on any Slow Channel Message CRC error.
- All CRC Errors: Triggers on any CRC error, Fast or Slow.

17.11.3 SENT Serial Decode

The configuration of SENT decoding is similar to that of I2C decoding.

On the bus:

- For Fast Channel:
- SYNC is displayed in pink
- STATE is displayed in green
- DATA is displayed in white
- CRC and Pause pulse are displayed in blue

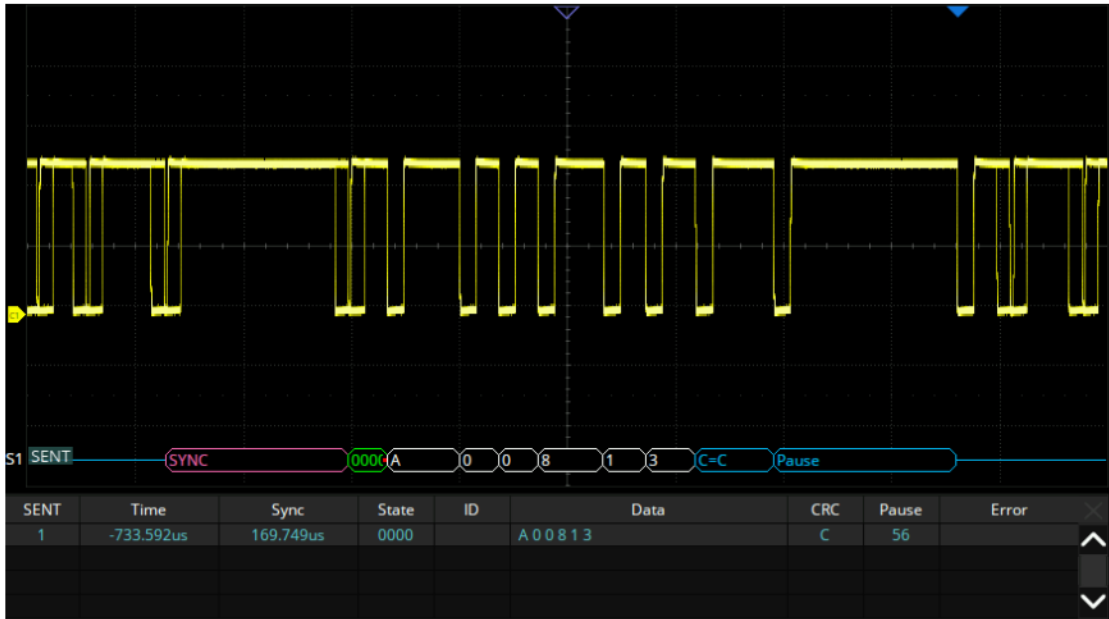

For Slow Channel:

- ID is displayed in green
- DATA are displayed in white
- CRC is displayed in blue

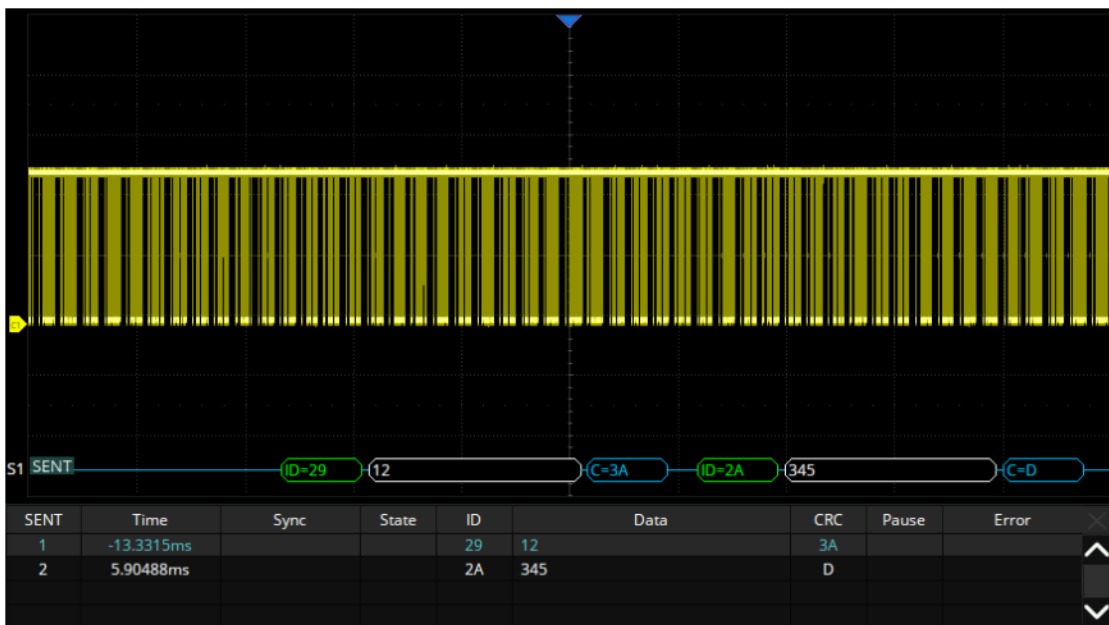

In the list view:

- **Time** -- The horizontal offset of the current data frame head relative to the trigger position.
- **Sync** -- Sync pulse width (only fast channel)
- **State** -- Status & Communication nibble (only fast channel)
- **ID** -- ID of the frame. (only slow channel)

- **Data** -- Data values
- **CRC** -- Cycle redundancy check
- **Pause** -- Pause ticks
- **Error** -- Error type

17.12 Manchester Serial Decode

This section covers decoding Manchester signals. Please read the following for more details: "Manchester Signal Settings" and "Manchester Serial Decode".

17.12.1 Manchester Signal Settings

Connect the Manchester signal to the oscilloscope, set the mapping relation between channels and signals, and then set the threshold level of the signal. The process of specifying the source and threshold is similar to "I2C Signal Settings"

In the **Protocol Config** menu of decode, the following parameters are available:

- A. Touch to specify the baud rate, the range is 500b/s to 5Mb/s
- B. Set the Manchester signal's logic type. R:1 indicates that rising edge is used to encode a bit value of logic 1, and F:1 indicates that falling edge is used to encode a bit value of logic 1
- C. Set the idle level
- D. Set the starting edge of the Manchester signal. The range is 1~32
- E. Set the minimum idle time/inter-frame gap time of the Manchester bus in terms of the bit width.
- F. Set the display format to Byte or Bit
- G. Set the bit order to MSB or LSB
- H. Set the sync field size, from 0 to 32
- I. Set the header size, from 0 to 32
- J. Set the number of words in the data field, from 1 to 255
- K. Set the data word size, from 2 to 8
- L. Set the trailer size, from 0 to 32
- M. Return to the previous menu

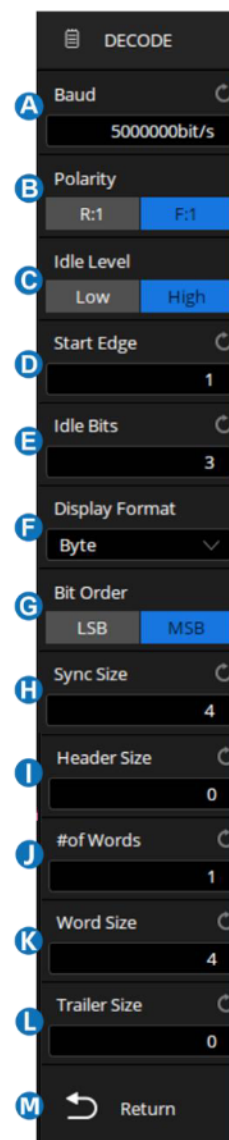

17.12.2 Manchester Serial Decode

The configuration of Manchester decoding is similar to that of I2C decoding.

On the bus:

- SYNC is displayed in pink
- The header is displayed in green
- DATA is displayed in white
- The trailer is displayed in blue

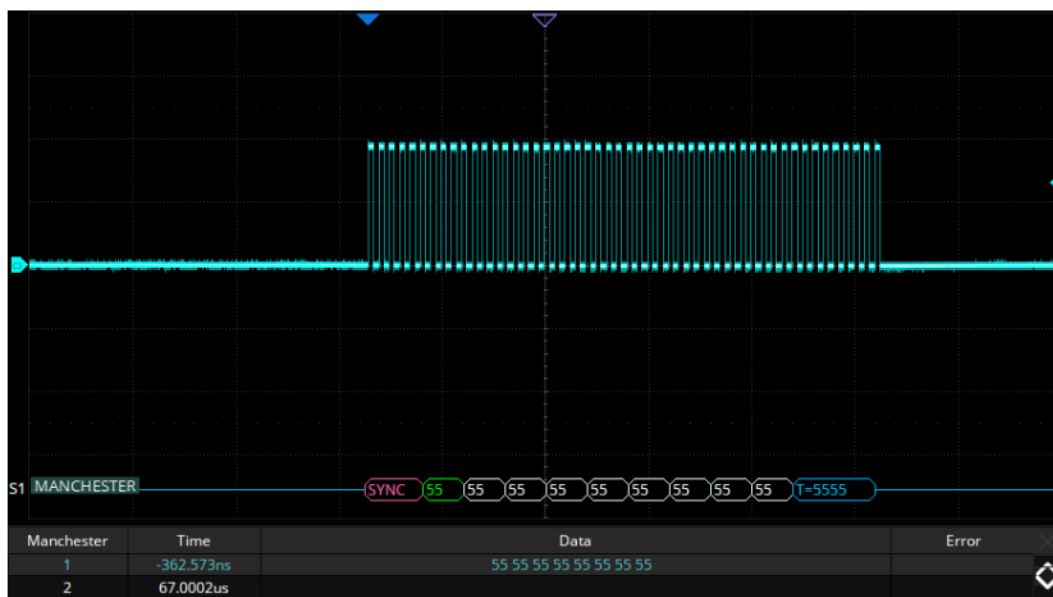

In the list view:

- **Time** -- The horizontal offset of the current data frame head relative to the trigger position.
- **Data** -- Data words
- **Error** -- Error type

17.13 ARINC 429 Trigger and Serial Decode

This section covers triggering and decoding ARINC 429 signals. Please read the following for more details: "ARINC 429 Signal Settings", "ARINC 429 Trigger" and "ARINC 429 Serial Decode".

17.13.1 ARINC 429 Signal Settings

Connect the A-line signal and the B-line signal to the oscilloscope, set the threshold level of the signal, and specify the triggering or decoding signal source (A-line, B-line, or A-B). The process of specifying the source and threshold is similar to "I2C Signal Settings".

In the **Protocol Config** menu of decode, the following parameters are available:

- A. Click to specify the baud rate: 12.5kbit/s, 100 kbit /s or Custom
- B. Set the Tolerance, the range is 1-20%
- C. Select the Word Format: Label, SDI, Data or SSM
- D. Return to the previous menu

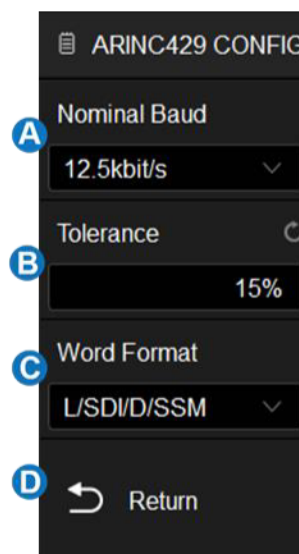

17.13.2 ARINC 429 Trigger

Click **Trigger Setting** in the ARINC 429 trigger dialog box to set the trigger condition:

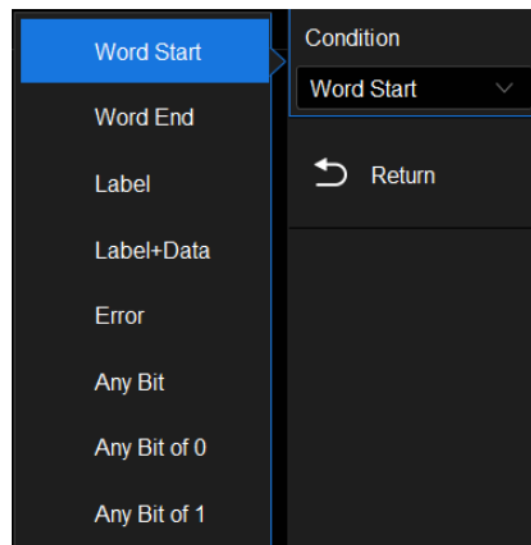

Word Start -- The oscilloscope triggers at the start of the word.

Word End -- The oscilloscope triggers at the end of the word.

Label -- The oscilloscope triggers when the specified label value appears.

- ✓ Click **Compare Type** to select: "=", ">" or "<"
- ✓ Click **Label(Octal)** to set the data value by the virtual keypad. The range of the data value is 0x00 to 0xff.

Label + Data -- The oscilloscope triggers when the specified label value and other word fields appear. Label value, data value, SDI, and SSM can be set.

Error -- The oscilloscope triggers on the error frame, include CRC Error, Byte Error, Gap Error, Byte Error or Gap Error, Any Error.

Any Bit -- The oscilloscope triggers on the presence of any bit that forms an eye diagram.

Any Bit of 0 -- The oscilloscope triggers on the presence of any bit with a value of 0.

Any Bit of 1 -- The oscilloscope triggers on the presence of any bit with a value of 1.

17.13.3 ARINC 429 Serial Decode

The configuration of ARINC 429 decoding is similar to that of I2C decoding. In the ARINC 429 decoding dialog box, the **Protocol Signals** and **Protocol Config** settings can be synchronized with ARINC 429 triggering through **Protocol Copy**.

On the bus:

- Label is displayed in frames and displayed in pink.
- SDI(Source/Destination Identifiers) is displayed in frames and displayed in green.
- DATA is displayed in frames and displayed in white.
- SSM(Signal/Status Matrix) is displayed in frames to describe the data properties of a transmission, and displayed in yellow.
- The red point at the end of a segment indicates there is not enough space on the display to show the complete content of a frame and some content is hidden.

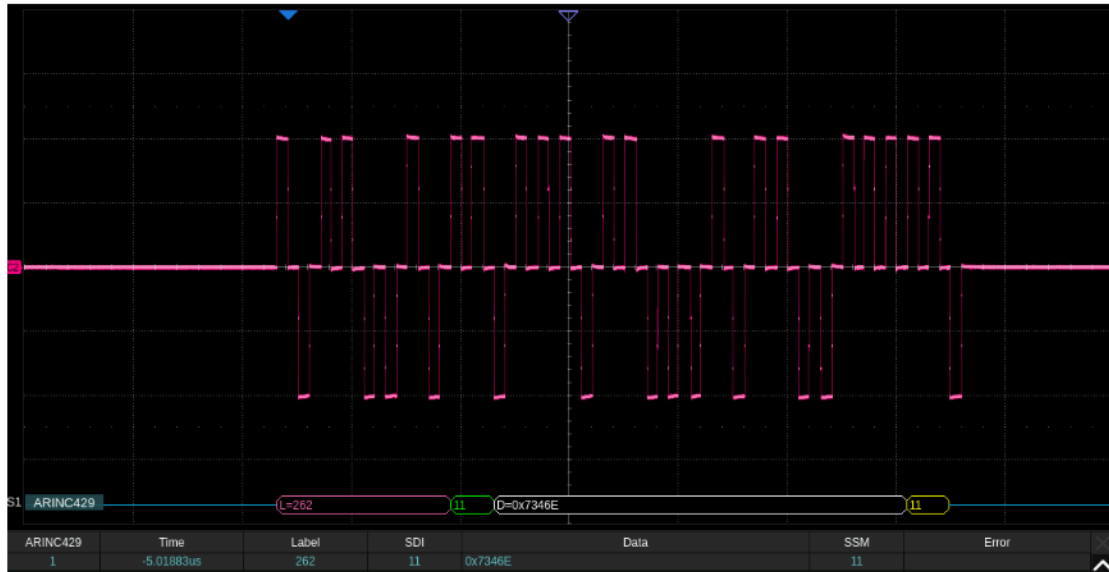

In the list view:

- **Time** -- The horizontal offset of the current data frame head relative to the trigger position.
- **Label** -- Octal format, used to indicate data type.
- **SDI** -- Indicate the origin/destination of data.
- **Data** -- Data values.
- **SSM** -- Describe the data properties of a transmission.
- **Error** -- Error type.

18 Cursors

18.1 Overview

Cursors are important tools when measuring signals. Rapid measurements can be performed using cursors in both horizontal and vertical directions. The cursor types include X1, X2, X1-X2, Y1, Y2, and Y1-Y2, used to indicate X-axis values (time or frequency) and Y-axis values (amplitude) on a selected waveform (C1~C4/F1~F4/M1~M4/Histogram).

Press the **Cursors** button on the front panel or touch the menu **Cursors** > **Menu** to open the cursors dialog box:

- A. Turn cursor function on or off
- B. Cursor Mode. The vertical cursors will automatically track the waveform in Trace mode.
- C. Specify the cursor
- D. Set the position of the specified cursor (by gestures, universal knob, or virtual keypad)
- E. Select the cursors type (horizontal, vertical, horizontal + vertical), this option is supported only in "Manual" mode.
- F. Select the source
- G. Display style of cursors text
- H. X cursor reference (Delay or Position)
 - Delay measures the cursor position relative to the Horizontal Delay/Offset position
 - Position measures the cursor position relative to the horizontal center of the display
- I. Y cursor reference (Offset or Position), this option is supported only in "Manual" mode.
 - Offset measures the cursor position relative to the Vertical/Offset position
 - Position measures the cursor position relative to the vertical center of the display

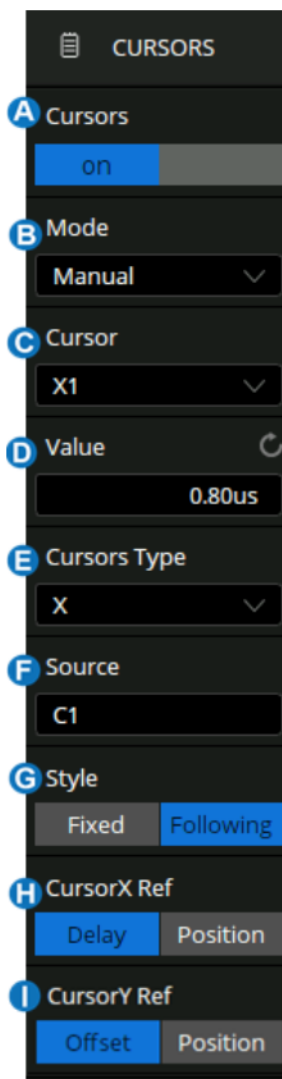

Cursors Mode

- **Manual** -- Manually sets the cursors' position. Cursors type (horizontal, vertical, horizontal + vertical) is available in this mode.
- **Track** -- The cursor type is automatically set to "horizontal + vertical". In this mode, only horizontal cursors are adjustable, while the vertical cursors automatically attach to the cross-point of the cursor and the source waveform.
- **Measure** -- Automatically indicates the measured item using cursors

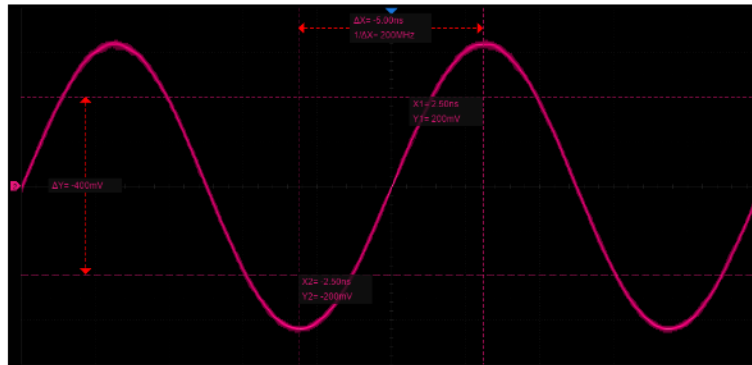

Manual Mode

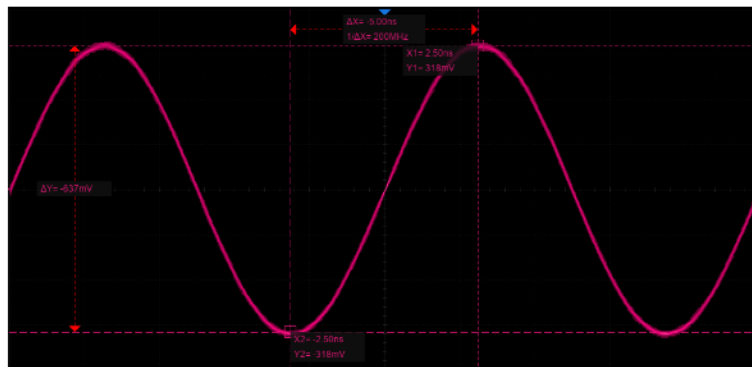

Track Mode

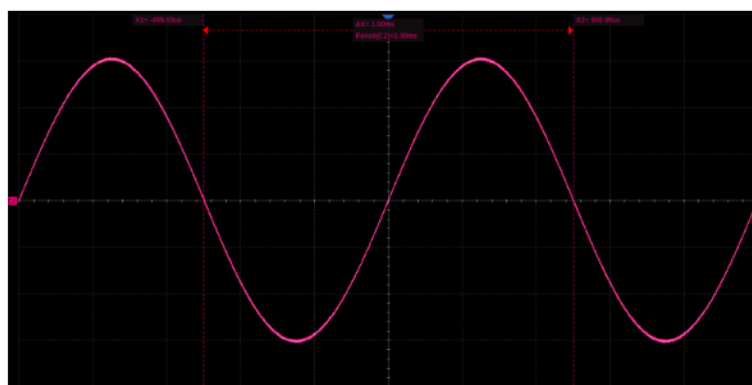

Measure Mode

Cursors Type

X (horizontal) -- Vertical dotted lines that measure horizontal time (when the source is an FFT waveform, X cursors measure frequency).

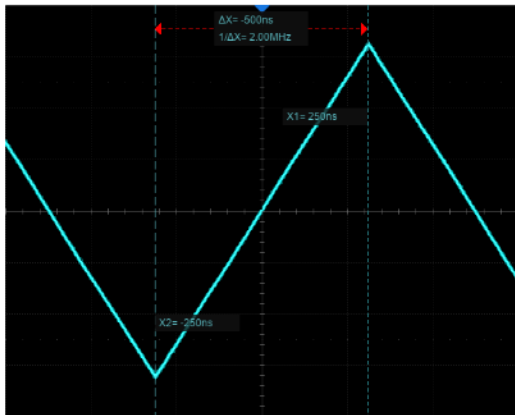

X cursors (time)

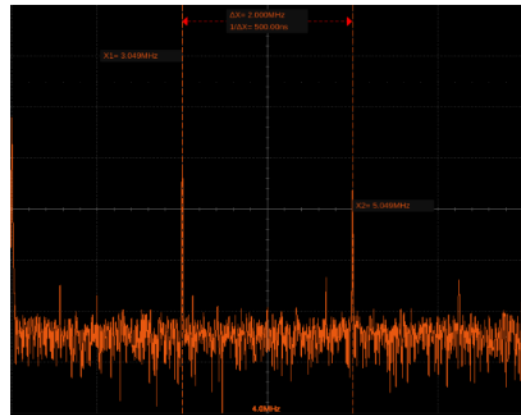

X cursors (frequency)

- **X1** -- The left (default) vertical dotted line. It can be manually moved to any horizontal position on the screen.
- **X2** -- The right (default) vertical dotted line. It can be manually moved to any horizontal position on the screen.
- **X1- X2** -- The difference between X1 and X2. After this option is selected, turning the universal knob will move both X1 and X2 simultaneously.

Y (vertical) -- Horizontal dotted lines that measure vertical voltage or current (depending on the unit of the selected channel). When the cursor's source is the math function, the units will match the math function.

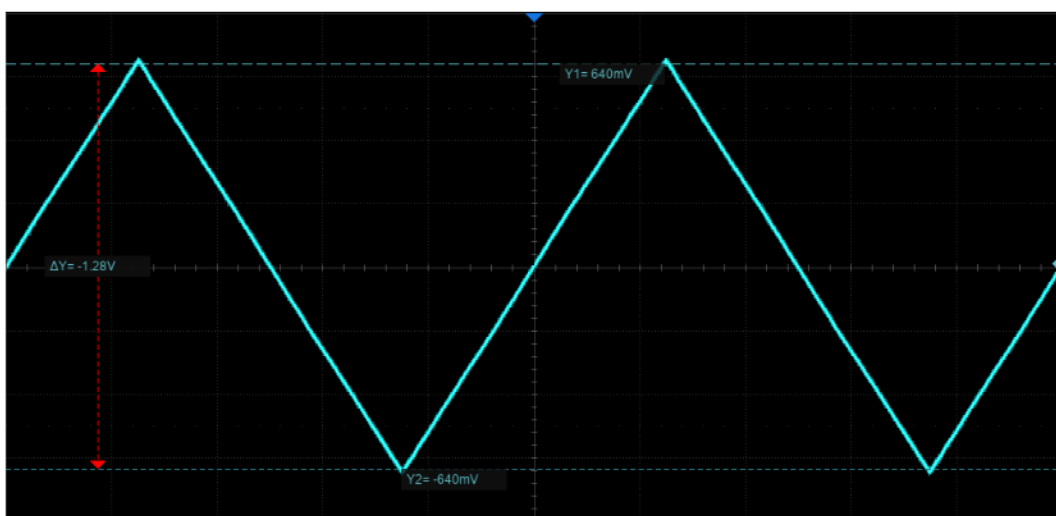

- **Y1** -- The upper (default) horizontal dotted line. It can be manually moved to any vertical position on the screen.

- **Y2** -- The lower (default) horizontal dotted line. It can be manually moved to any vertical position on the screen.
- **Y1- Y2** -- The difference between Y1 and Y2. After this option is selected, turn the universal knob to move both Y1 and Y2 simultaneously.

X+Y (horizontal + vertical) -- Both the X cursors and Y cursors are enabled.

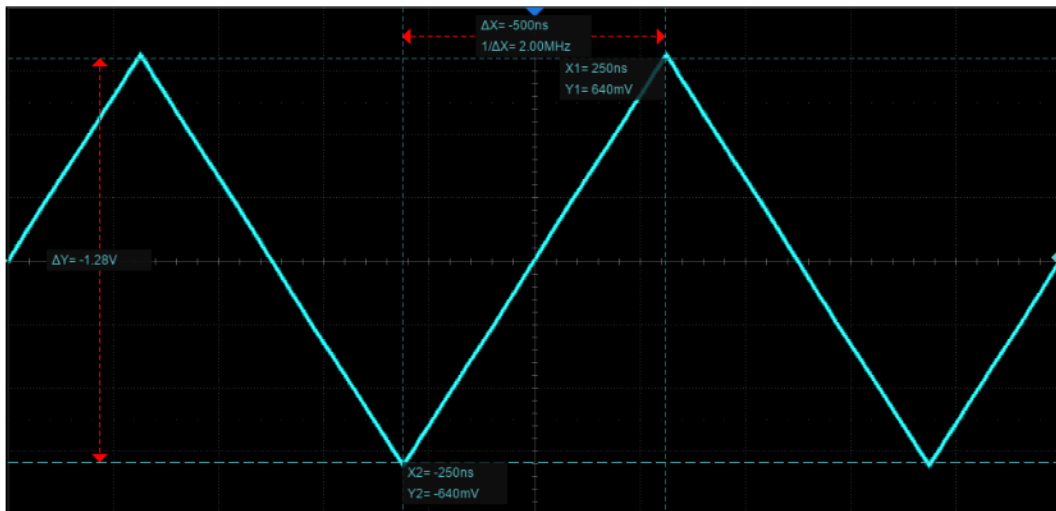

Display Mode

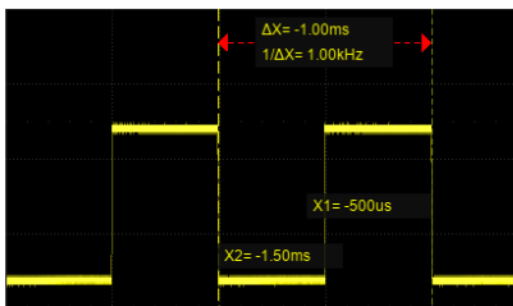

Display Mode Following

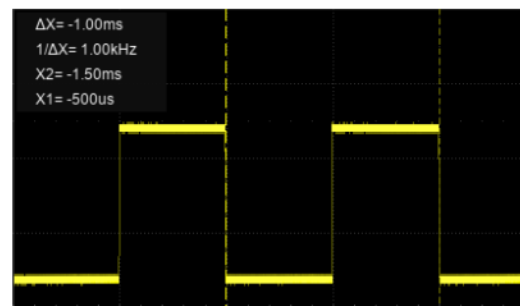

Display Mode Fixed

- **Following** -- The position information of each cursor is attached to the cursor, and the difference information is between the two cursors with arrows connected to the cursors. This mode is more intuitive.
- **Fixed** -- The position information of each cursor and the difference between the cursors are displayed in a region on the screen. The region can be moved by gestures to avoid covering the waveform. This mode is relatively concise.

Cursors Reference

X cursors reference:

- **Fixed Delay** -- When the timebase is changed, the value of X cursors remains fixed.

- Fixed Position -- When the timebase is changed, the X cursors remain fixed to the grid position on the display.

Y cursors reference:

- Fixed Offset -- When the vertical scale is changed, the value of Y- cursors remain fixed.
- Fixed Position -- When the vertical scale is changed, the Y-cursors remain fixed to the grid position on the display.

Take X cursors reference as an example to demonstrate the scaling effect of different settings:

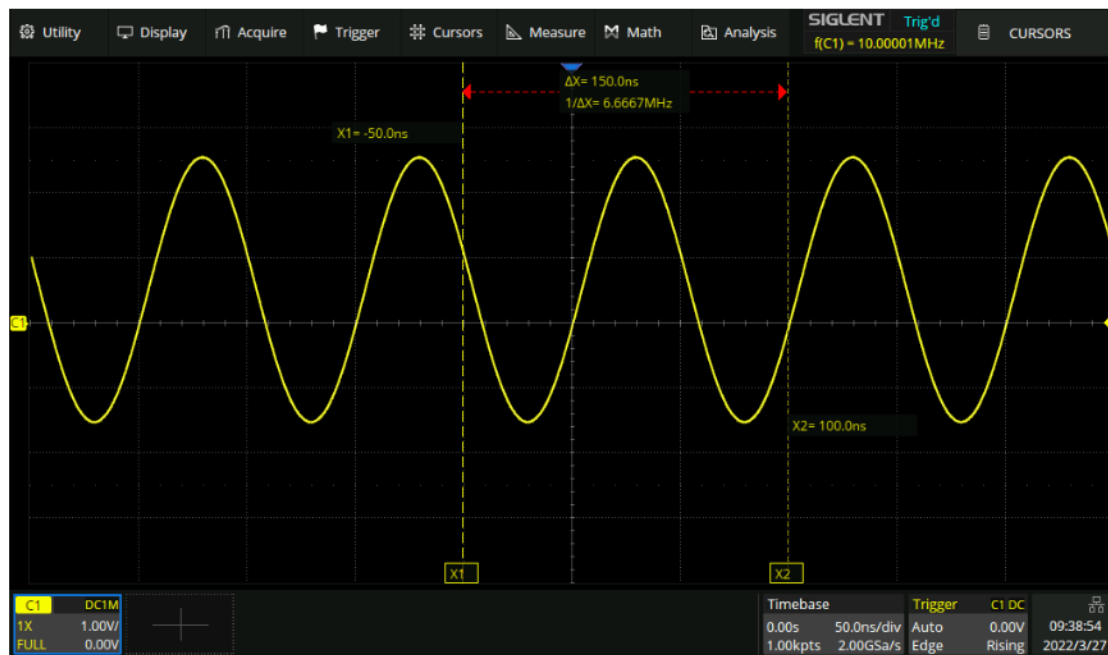

Timebase=50ns/div , X1=-50ns=-1div , X2=100ns=2div

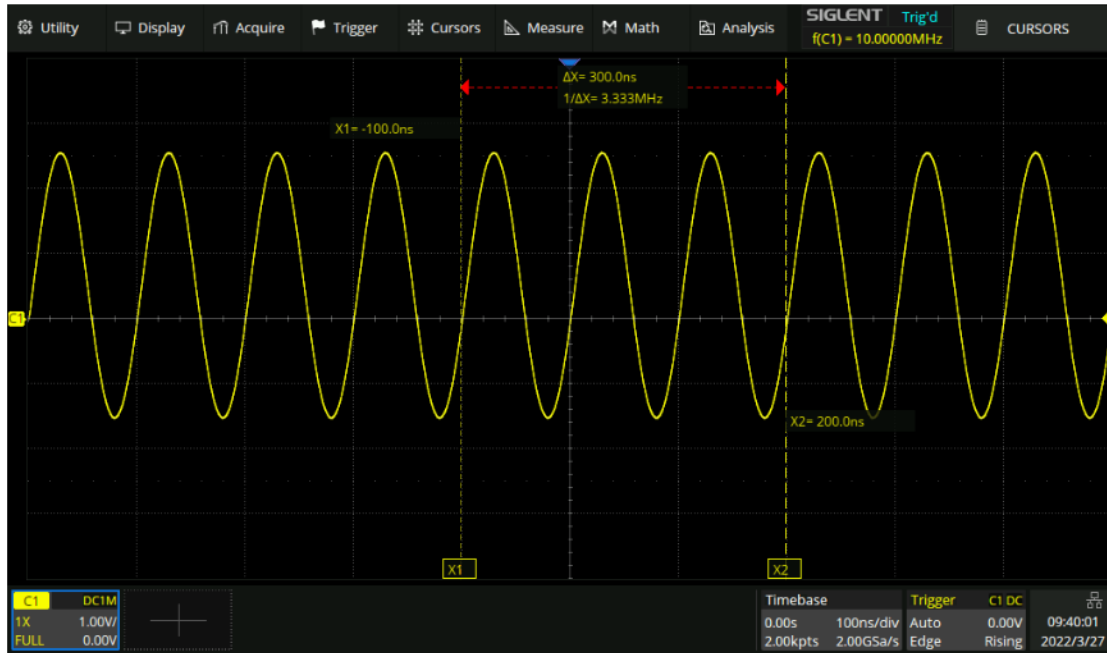

Fixed position, timebase is changed to 100 ns/div, the grid number of X cursors (-1div, 2div) remains fixed. The value of X1 and X2 is changed to -100 ns, 200 ns.

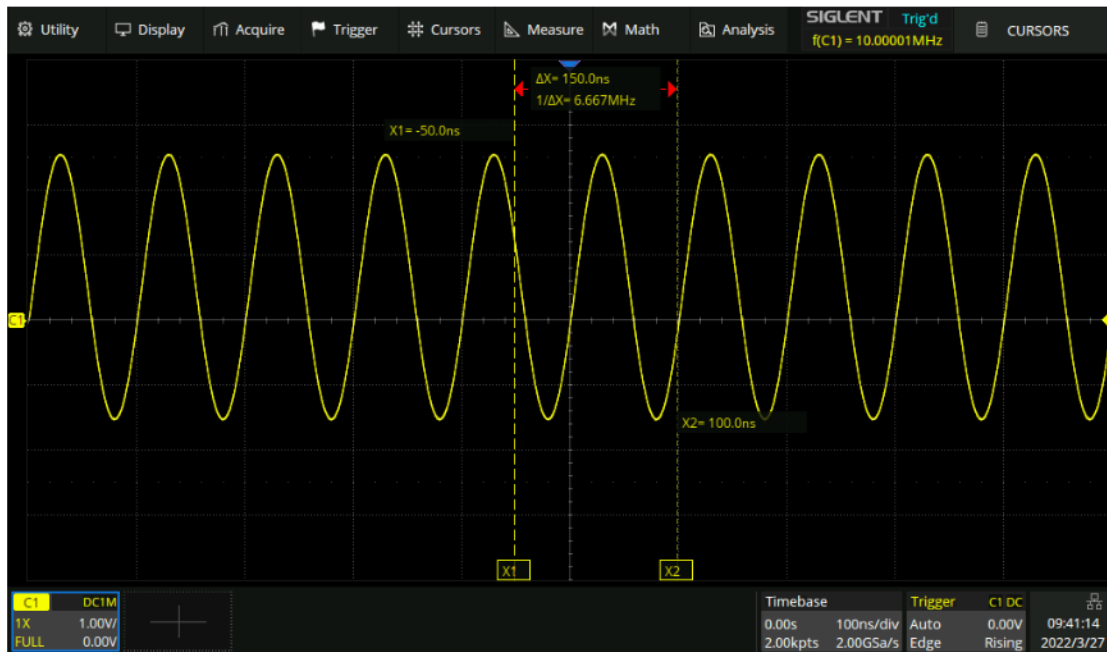

Fixed delay, timebase is changed to 100 ns/div, the value of X cursors (-50 ns, 100 ns) remains fixed. The grid number of X cursors is changed to -0.5div, 1div.

18.2 Select and Move Cursors

The cursors can be selected and moved directly by gestures and the universal knob on the front panel, in addition, they can be selected in the cursor's value dialog box.

Gestures

Directly touch the cursor and drag it, as shown below:

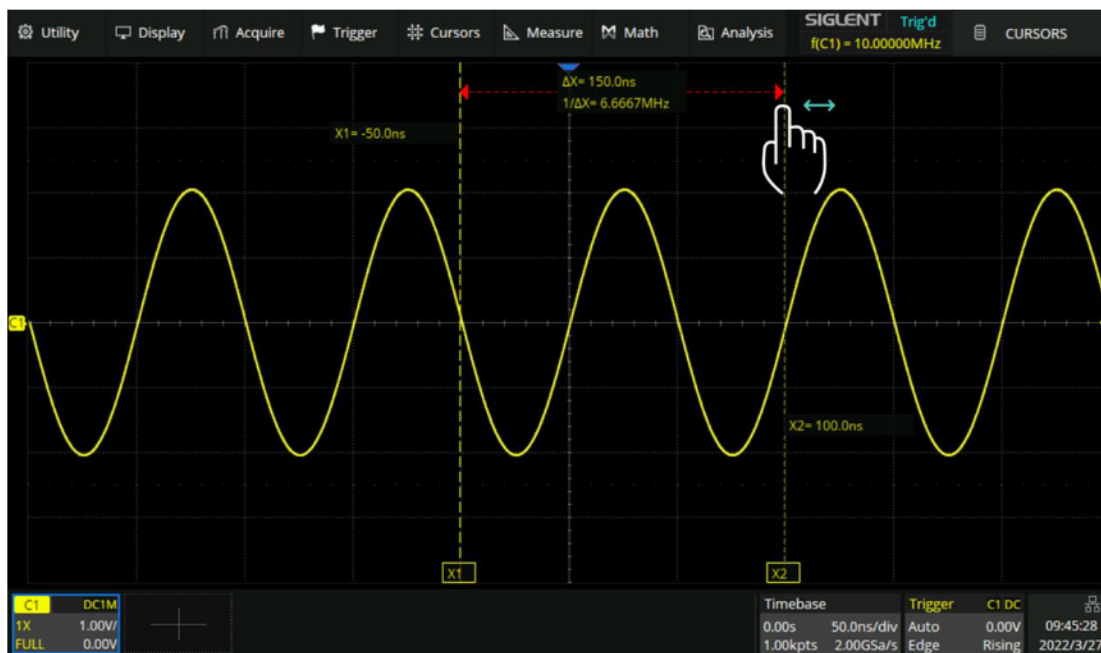

Touch the display area of ΔX (or ΔY) in M1 mode and drag it to move the two cursors simultaneously, as shown in the figure below. This is equivalent to the operation on the cursor type X1-X2 or Y1-Y2.

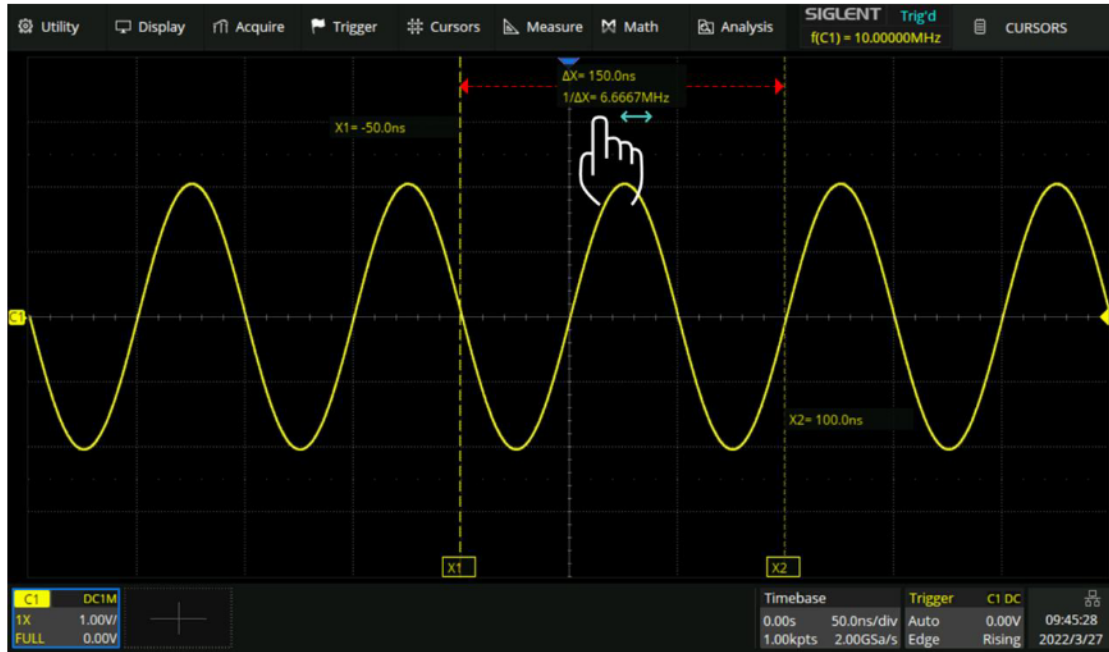

Universal Knob

Move the cursor position by turning the universal knob on the front panel. Press the knob to select different cursor lines. For example, if the current cursor is X1, press to select X2, and press again to select X1-X2.

Gestures move the cursor quickly but not precisely, while the knob moves the cursor precisely but not as quickly. You can use both in combination to suit your needs: First, a rough adjustment is achieved by using gestures, and then the fine adjustment is achieved by using the universal knob.

Dialog Box

Touch the cursor value area of the dialog box, and then rotate the universal knob to adjust the position.

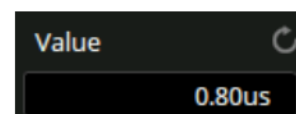

19 Measurement

19.1 Overview

The SDS3000X HD features a strong automatic measurement list. These parameters can be automatically measured without cursors and include common measurements such as rise time, fall time, peak-peak, and period. The SDS3000X HD can also measure multiple channels at the same time, showing up to 5 parameter measurements with statistics while in the M1 display mode and up to 12 parameters in the M2 mode. If you wish to view more parameters on a specified channel, then the "Simple" mode can be employed. For measuring waveform of interest in a time gate, the "Gate" function is suggested.

Some parameter measurements (such as the mean) may be a value generated by all the data in a frame. Some parameter measurements (such as period) accumulate all measurements in a frame, but the displayed value is always the first value. If you want to know the distribution of multiple parameters in one frame, you should use the statistics function.



- A. The waveform display area automatically compresses when the other windows are displayed
- B. Measurement parameters and statistics display area. If select the mode as "Simple", the "Simple" parameter area is displayed
- C. Statistics histogram display area
- D. Measure dialog box

Press the **Measure** button on the front panel or touch **Measure** > **Menu** to open the dialog box.

- A. Enable/disable measure
- B. Set the mode of measure: Simple or Advanced. "Simple" shows the specified basic measurement parameters of the selected channel. In "Advanced" mode, the measurement parameters can be added one by one as needed
- C. Measure configuration: gate, amplitude strategy, threshold, and display mode
- D. Clear all the selected measurements
- E. Select measurement parameters
- F. Tools including Trend, Track, and Measure Cursor
- G. Turn on or off statistics
- H. Statistics settings: count limit, AIM limit, reset statistics, and histogram

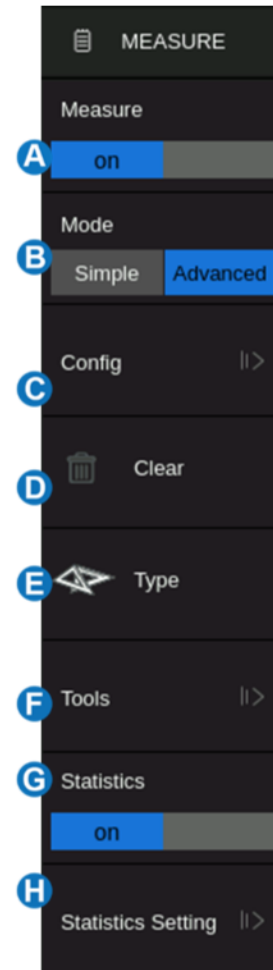

19.2 Set Parameters

Touch **Type** in the measure dialog box, or touch **+** in the measurement parameters and statistics display area to open the parameter selection window:

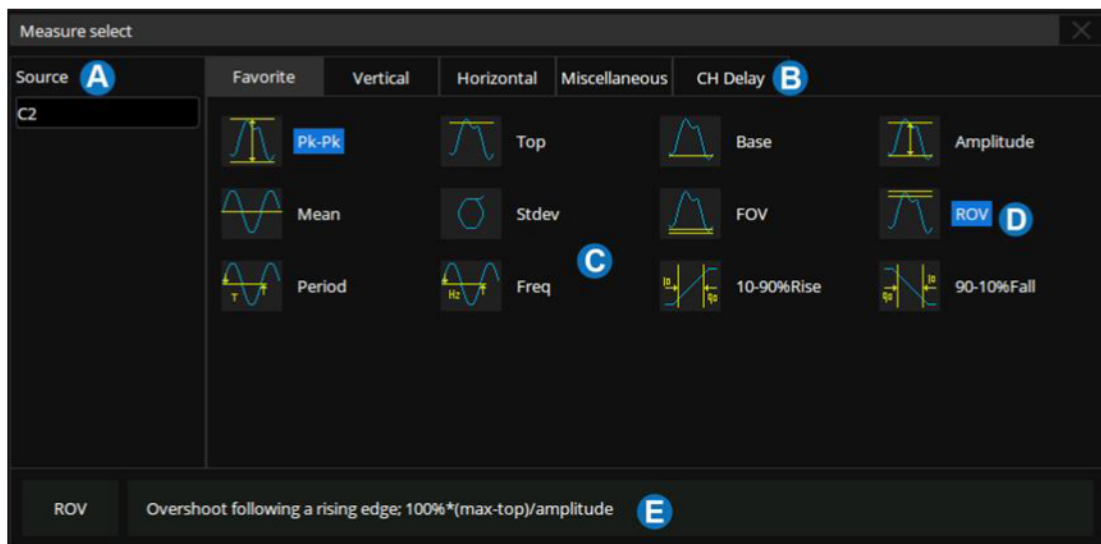

- A. Set the source of the current setting.
- B. Measurement parameter classification tabs, including Favorite, Vertical, Horizontal, Miscellaneous, and CH Delay. Touch a tab and in the **C** area will display the corresponding parameters
- C. Parameters. Touch the parameter to be measured to activate it, and touch it again to close the parameter.
- D. Background highlighted parameters represent it is activated. In the figure above, "Pk-Pk" and "ROV" are activated.
- E. Description of the last selected parameter.

The correct steps to add a measurement parameter are to select the source in the **A** area and then select the parameter in the **C** area. For example, to add Pk-Pk measurements for C1 and Period measurements for C2, follow the steps below:

Source > **C1** > **Vertical** > **Pk-Pk**

Source > **C2** > **Horizontal** > **Period**

For the channel delay (CH Delay) measurement, because the number of sources involved is greater than 1, the steps to specify the source is different:



In the parameter selection area, the channel corresponding to **Source A** is specified first, and then the channel corresponding to **Source B**. Finally, the measurement parameter is selected. For example, to activate the skew between C1 and C2, you can follow the following steps:

Source A > **C1** > **Source B** > **C2** > **Skew**

Once a parameter is selected, it will appear in the parameter and statistical display area below the grid:

| MEASURE | Pk-Pk(C1) | ROV(C1) | Period(C2) | Phase(C1,C2) |
|---------|-----------|---------|------------|--------------|
| Value | 417mV | 2.52% | 995.2ns | -21.28° |

Touch **+** in the blank area to add a parameter.

Touch **-** in the upper right corner of each parameter to close the parameter.

Touch **x** in the upper right corner of the area to close measurement.

Touch **Clear** in the dialog box to close all parameters.

The “Favorite” tab is used to store frequently used items. You can customize this tab. Up to 20 items can be stored in it. Long-press an item to add or remove it from the “Favorite” tab. For example, to add Pk-Pk to the “Favorite” tab:

Advanced > **Type** > **Vertical** > **Pk-Pk** > **Add to favorite**

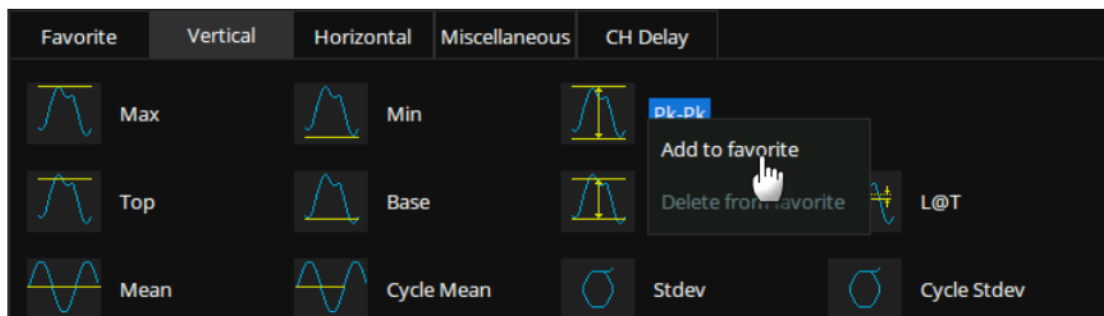

To remove Period from the “Favorite” tab:

Advanced > *Type* > *Favorite* > *Period* > *Delete from favorite*

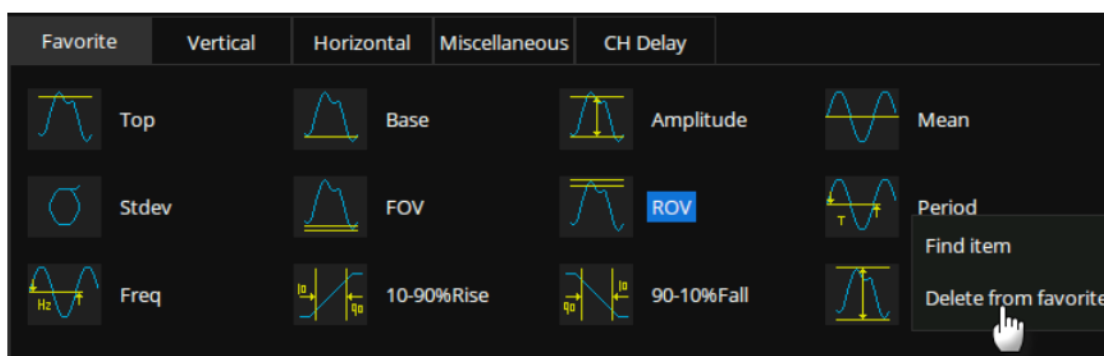

19.3 Type of Measurement

19.3.1 Vertical Measurement

Vertical measurement includes 19 parameters:

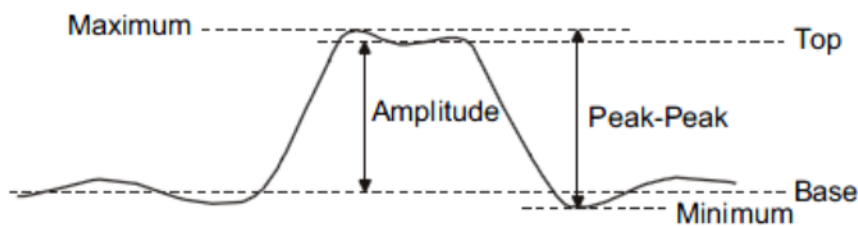
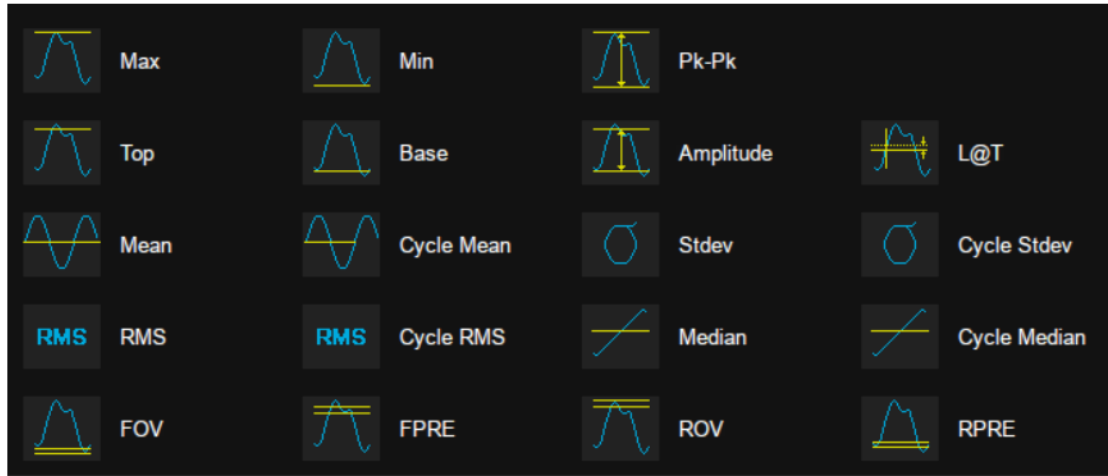

- **Max:** Highest value in the input waveform
- **Min:** Lowest value in the input waveform
- **Pk-Pk:** Difference between maximum and minimum data values
- **Top:** Value of most probable higher state in a bimodal waveform
- **Base:** Value of most probable lower state in a bimodal waveform
- **Amplitude:** Difference between top and base in a bimodal waveform. If not bimodal, the difference between max and min
- **Mean:** Average of data values
- **Cycle Mean:** Average of data values in the first cycle
- **Stdev:** Standard deviation of the data
- **Cycle Stdev:** Standard deviation of the data in the first cycle
- **RMS:** Root mean square of the data
- **Cycle RMS:** Root mean square of the data in the first cycle
- **Median:** Value at which 50% of the measurements are above and 50% are below
- **Cycle Median:** Median of the first cycle

- **Overshoot (FOV):** Overshoot following a falling edge; $100\% \times (\text{base-min})/\text{amplitude}$
- **Overshoot (ROV):** Overshoot following a rising edge; $100\% \times (\text{max-top})/\text{amplitude}$

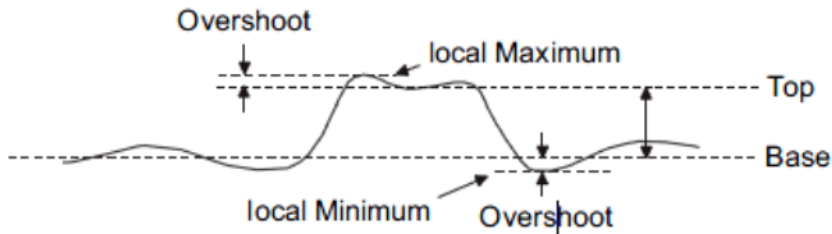

$$\text{Rising Edge Overshoot} = \frac{\text{Maximum} - \text{Top}}{\text{Amplitude}} \times 100\%$$

$$\text{Falling Edge Overshoot} = \frac{\text{Minimum} - \text{Base}}{\text{Amplitude}} \times 100\%$$

- **Preshoot (FPRE):** Overshoot before a falling edge. Equal to $100\% \times (\text{max-top})/\text{amplitude}$.
- **Preshoot (RPRE):** Overshoot before a rising edge. Equal to $100\% \times (\text{base-min})/\text{amplitude}$.

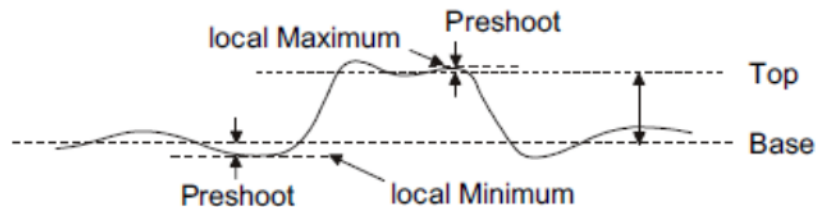

$$\text{Falling Edge Preshoot} = \frac{\text{Maximum} - \text{Top}}{\text{Amplitude}} \times 100\%$$

$$\text{Rising Edge Preshoot} = \frac{\text{Minimum} - \text{Base}}{\text{Amplitude}} \times 100\%$$

- **L@T:** Level measured at trigger position

19.3.2 Horizontal Measurement

Horizontal measurement includes 17 parameters:

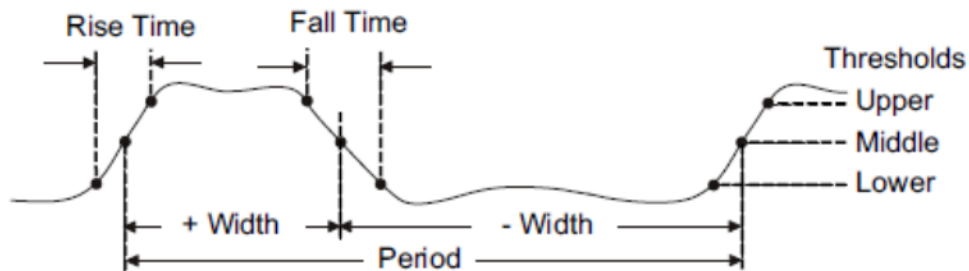
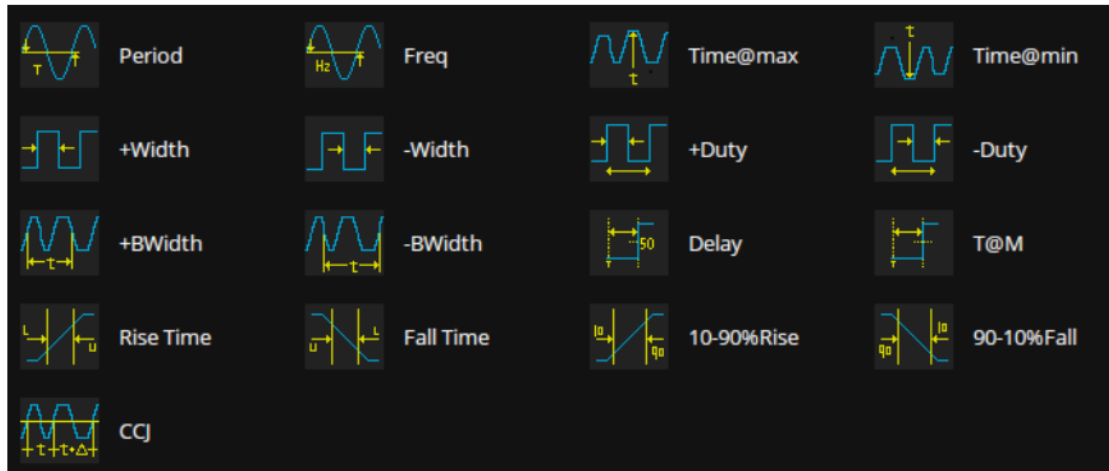

- **Period:** Time between the middle threshold points of two consecutive like-polarity edges.
- **Freq:** Reciprocal of the period
- **Time@max:** First time of maximum value
- **Time@min:** First time of minimum value
- **+Width:** Time difference between the middle threshold of a rising edge to the middle threshold of the next falling edge of the pulse
- **-Width:** Time difference between the middle threshold of a falling edge to the middle threshold of the next rising edge of the pulse
- **+Duty:** Positive Duty Cycle. The ratio of positive width to period
- **-Duty:** Negative Duty Cycle. The ratio of negative width to period
- **+BWidth:** Time from the first rising edge to the last falling edge at the middle threshold
- **-BWidth:** Time from the first falling edge to the last rising edge at the middle threshold
- **Delay:** Time from the trigger to the first transition at the middle threshold
- **T@M:** Time from the trigger to each rising edge at the middle threshold
- **Rise Time:** Duration of rising edge from lower threshold to upper threshold

- **Fall Time:** Duration of falling edge from upper threshold to lower threshold
- **10-90% Rise:** Duration of rising edge from 10-90%
- **90-10% Fall:** Duration of falling edge from 90-10%
- **CCJ:** The difference between two continuous periods

19.3.3 Miscellaneous Measurements

The Miscellaneous measurements tab includes 16 parameters:

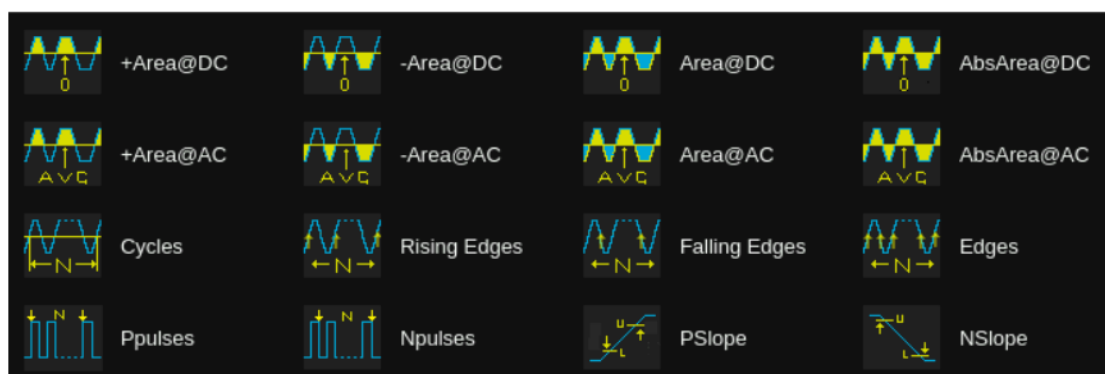

- **+Area@DC:** Area of the waveform above zero
- **-Area@DC:** Area of the waveform below zero
- **Area@DC:** Area of the waveform
- **AbsArea@DC:** Absolute area of the waveform
- **+Area@AC:** Area of the waveform above average
- **-Area@AC:** Area of the waveform below average
- **Area@AC:** Area of the waveform above the average minus the area of the waveform below average
- **AbsArea@AC:** Area of the waveform above the average plus the area of the waveform below the average
- **Cycles:** Number of cycles in a periodic waveform
- **Rising Edges:** Number of rising edges in a waveform
- **Falling Edges:** Number of falling edges in a waveform
- **Edges:** Number of edges in a waveform
- **Ppulses:** Number of positive pulses in a waveform
- **Npulses:** Number of negative pulses in a waveform
- **PSlope:** The slope of the rising edge
- **NSlope:** The slope of the falling edge

19.3.4 Delay Measurement

Delay measurement measures the time difference between two channels. It includes 14 delay parameters:



- **Phase:** Phase difference between two edges
- **Skew:** Time of source A edge minus time of nearest source B edge
- **FRFR:** The time between the first rising edge of source A and the following first rising edge of source B at the middle threshold
- **FRFF:** The time between the first rising edge of source A and the following first falling edge of source B at the middle threshold
- **FFFR:** The time between the first falling edge of source A and the following first rising edge of source B at the middle threshold
- **FFFF:** The time between the first falling edge of source A and the following first falling edge of source B at the middle threshold
- **FRLR:** The time between the first rising edge of source A and the last rising edge of source B at the middle threshold
- **FRLF:** The time between the first rising edge of source A and the last falling edge of source B at the middle threshold
- **FFLR:** The time between the first falling edge of source A and the last rising edge of source B at the middle threshold
- **FFLF:** The time between the first falling edge of source A and the last falling edge of source B at the middle threshold
- **Tsu@R:** Data setup time before the clock rising edge
- **Tsu@F:** Data setup time before the clock falling edge
- **Th@R:** Data hold time after the clock rising edge
- **Th@F:** Data hold time after the clock falling edge
- **ΔTime1-4:** ΔTime between two edges

19.4 Trend

After adding a measurement parameter, a Trend can be used to observe the long-term change of the selected measurement value over time.

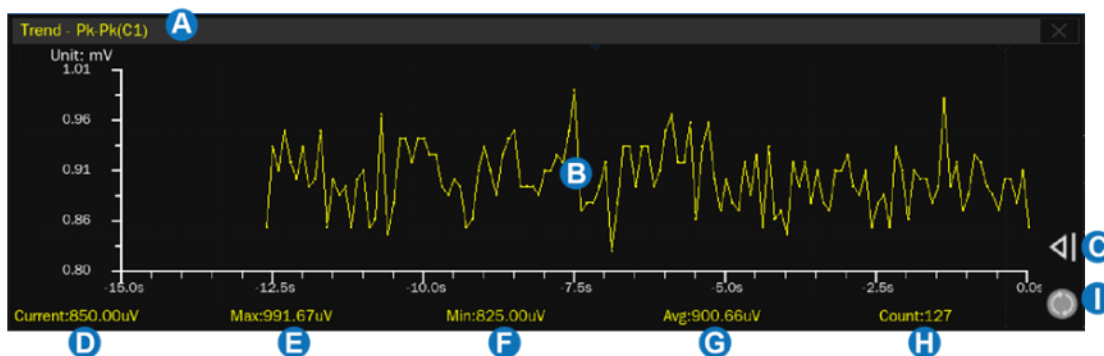

- A. Measurement parameter display area
- B. Trend plot display area
- C. Extend the range of time. Touch it to expand the time range.
- D. Current value
- E. Maximum value
- F. Minimum value
- G. Average value
- H. Number of measurements, up to 1,000,000 supported
- I. Reset statistics

Press the **Clear Sweeps** button or touch **Reset Statistics** in the measure dialog box, or touch the symbol  in the statistics display area to clear and restart statistics.

19.5 Track

The measure values VS. time plot of a horizontal parameter (e.g. frequency, rise time) in one frame can be observed when the Track is enabled.

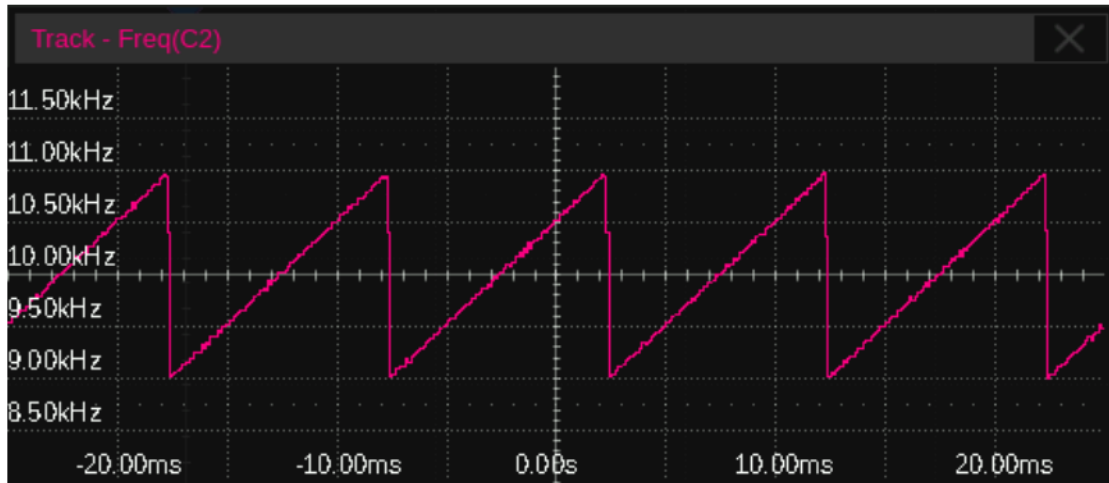

The upper limit of the statistic number in a frame is set in **Statistics** > **AIM Limit**, which means the values exceeding the limit will not be shown in the track plot.

19.6 Display Mode

In advanced measurement mode, two display modes are supported: M1 and M2.

In M1 mode, up to 5 parameter measurements are displayed at a time. When statistics are enabled, they are listed under the measurement items. Touch a column to add or replace a measurement.

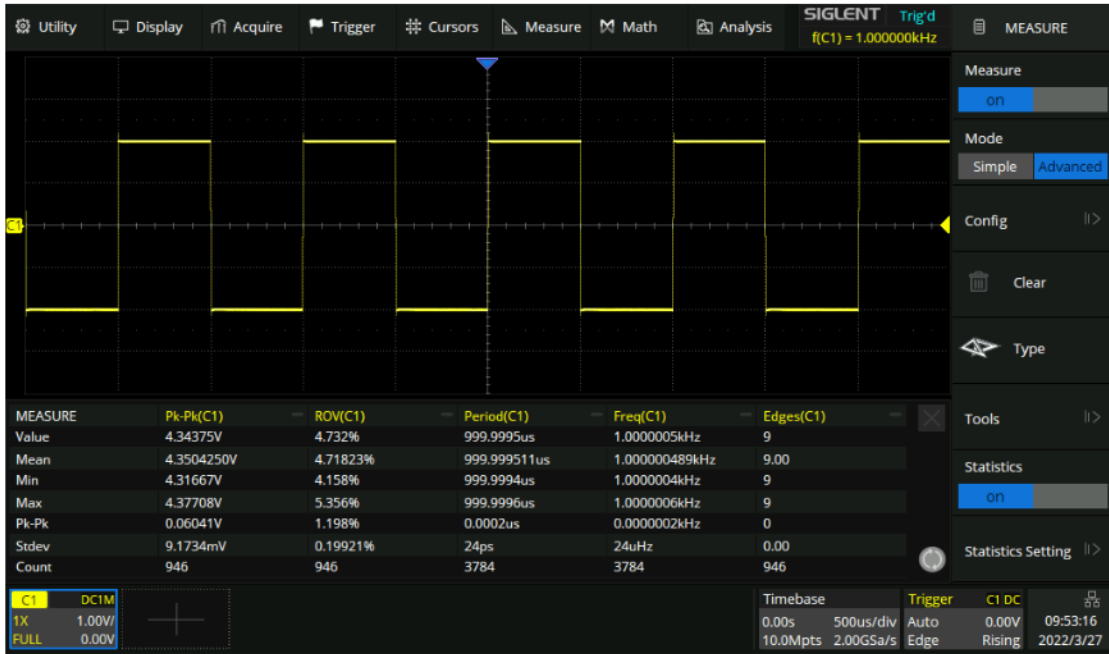

In M2 mode, up to 12 parameter measurements are displayed at a time. When statistics are enabled, they are distributed on the right side of the measurement item. Touch a row to add or replace a measurement.



Note: In M2 mode histogram display is not supported.

19.7 Measurement Statistics

Measurement statistics are based on the total number of captured waveforms. In Roll mode, measurement statistics increase over time. Touch **Statistics Setting** in the measure dialog box to recall the Statistics Config dialog box:

- Set the maximum number of samples for the statistics function. The setting range is 1 ~ 1024, or unlimited. If there is no limit, the number of statistics will be accumulated. If there is a limit, when the maximum number of statistics N is reached, only the latest N measurements will be counted. When the count is limited, only the first period measurement value of each frame is counted
- Set the upper limit of the statistic number in a frame. Valid only when the count limit is set to "Unlimited".
- Clear and restart the statistics. Pressing the **Clear Sweeps** button on the front panel has an equivalent effect
- Turn the histogram on or off
- Return to the previous menu

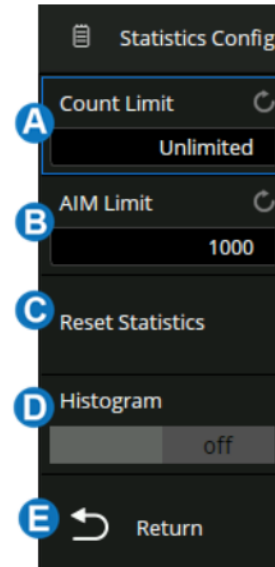

Enable the **Statistics** function to observe the distribution of the measured values of every selected parameter.

| MEASURE | Pk-Pk(C1) | Base(C1) | Period(C1) | 10-90% Rise(C1) | +Duty(C1) |
|---------|------------|------------|---------------|-----------------|-----------|
| Value | 3.01412V | 16.47mV | 999.99997us | 214.33ns | 50.001% |
| Mean | 991.7647mV | -11.5126mV | 726.0068383us | 23.4860018us | 50.00055% |
| Min | 49.41mV | -117.65mV | 3.86921us | 210.10ns | 50.001% |
| Max | 3.07765V | 70.59mV | 1.00000041ms | 486.37243us | 50.001% |
| Pk-Pk | 3.02824V | 188.24mV | 996.13120us | 486.16233us | 0.000% |
| Stdev | 1.3543659V | 30.9758mV | 414.4778473us | 103.5048571us | 0.00000% |
| Count | 28 | 28 | 13 | 21 | 1 |

- Value** -- The current measurement
- Mean** -- Average of all historical measurements
- Min** -- The minimum of all historical measurements
- Max** -- The maximum of all historical measurements
- Stdev** -- Standard deviation of all historical measurements
- Count** -- The number of historical measurements

Press the **Clear Sweeps** button or touch **Reset Statistics** in the statistics setting dialog box, or touch the symbol  in the statistics display area to clear and restart statistics.

When the oscilloscope detects the trace under test is clipped, an extra overflow indicator will appear after the measurement value:

- >2.02353V(↑)** Waveform clipped at the top
- >2.02353V(↓)** Waveform clipped at the bottom
- >1.922353V(↑↓)** Waveform clipped at both top and bottom

19.8 Statistics Histogram

After enabling statistics on a selected measurement, you can also activate a statistical histogram. The histogram appears at the bottom of the statistics area. This enables users to quickly view the probability distribution of the measured parameters. The color of the histogram is consistent with the measurement source (Channel 1 is yellow, etc.).

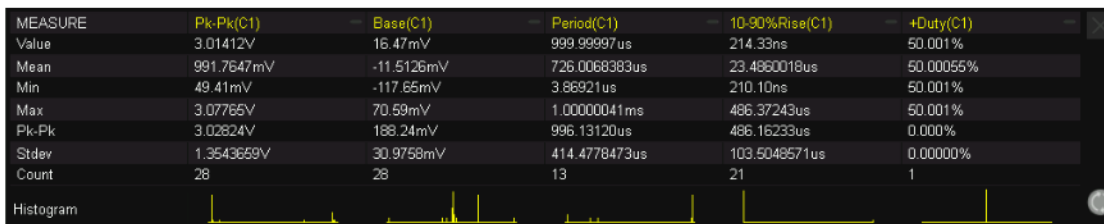

Touch the histogram area of a parameter to enlarge it for details. You can move the large histogram window position around the display by dragging. Touch the histogram of another parameter to switch to the corresponding enlarged histogram.

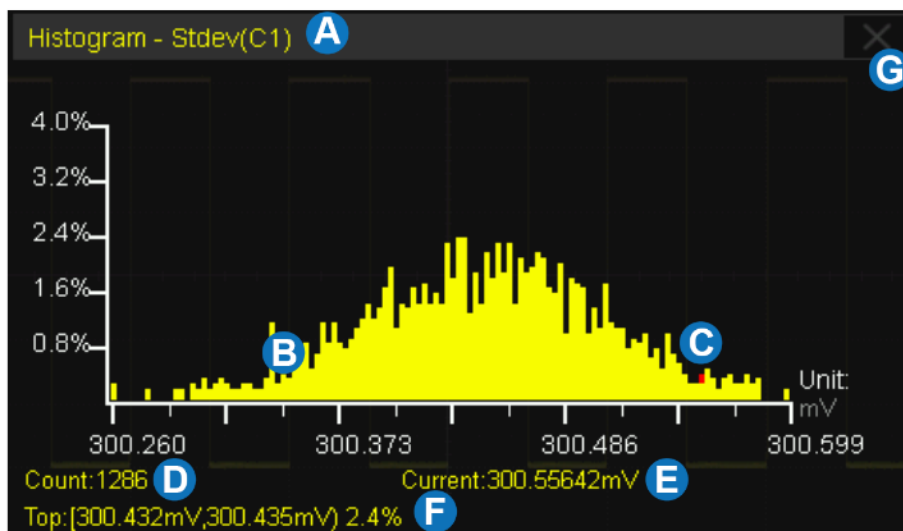

A. Parameter

- B. Histogram display area. The X-axis represents measured values and Y-axis represents the probability.
- C. Current measurement point. Different measurement sources may indicate different colors of indicator points
- D. Count of statistics
- E. Current value
- F. The bin that includes the maximum value and the probability of a value falling into it
- G. Close the enlarged histogram

19.9 Simple Measurements

Enabling Simple Measurement displays all selected measurement parameters of the specified channel at the same time. The font color of the measurement parameters is consistent with the color of the specified source. Yellow for Channel 1, Purple for Channel 2, etc.

| | | | | | | | |
|-----------|---------|-------------|---------|--------|----------|--------|---------|
| Max | 1.58V | Cycle Mean | -4.28mV | ROV | 2.22% | Rise | 2.00ns |
| Min | -1.58V | Stdev | 1.50V | RPRE | 0.56% | Fall | 2.00ns |
| Pk-Pk | 3.17V | Cycle Stdev | 1.50V | L@T | 233.33mV | BWidth | 4.50ms |
| Top | 1.50V | RMS | 1.50V | Period | 1.00ms | +Duty | 50.00% |
| Base | -1.50V | Cycle RMS | 1.50V | Freq | 1.00kHz | -Duty | 50.00% |
| Amplitude | 3.00V | FOV | 2.78% | +Width | 500.00us | Delay | -2.50ms |
| Mean | -4.19mV | FPRE | 0.0% | -Width | 500.00us | T@M | 1.50ms |

19.10 Gate

Sometimes the user may want to measure parameters for a certain specified time range of the signal and ignore signal parts that lie outside of that range. In this case, the Gate function can be helpful. See "Analysis Gate" for details.

19.11 Amplitude Strategy

According to different types of input signals, users can choose the corresponding amplitude calculation strategy which can measure top and bottom values with more accuracy.

Touch **Config** > **Amplitude Strategy** in the measure dialog box to recall the amplitude strategy dialog box:

- A. Set the amplitude calculation strategy. When set to Auto, the amplitude calculation strategy will be selected automatically according to the input signal to ensure the accuracy of the measured value
- B. Set the top value calculation strategy. When set to Histogram, the value at the upper half of the waveform will be counted, and the value with the maximum probability will be identified as the top value; when set to max, the maximum value of the waveform will be identified as the top value

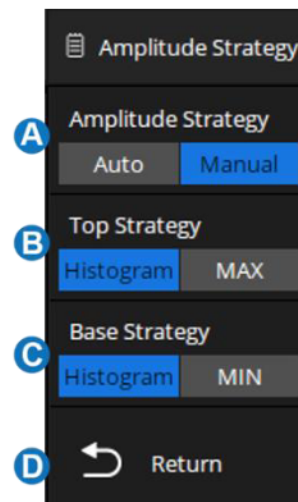

- C. Set the base value calculation strategy. When set to Histogram, the value at the lower half of the waveform will be counted, and the value with the maximum probability will be identified as the base value; when set to min, the minimum value of the waveform will be identified as the base value
- D. Return to the previous menu

19.12 Threshold

Measurement thresholds can be defined by the user. This is more flexible than fixed thresholds. For example, for pulse-width measurement, the threshold can be specified rather than fixed at 50%. For rise time, the lower / upper thresholds can be specified rather than fixed at 10% / 90%.

Changing the default threshold may change the measurement results of relevant measurement items, such as Period, frequency, +width, -width, +duty, -duty, +BWidth, -BWidth, delay, T@M, rise time, fall time, CCJ, cycles, rising edges, falling edges, edges, Ppulses, Npulses, and delay measurement.

Touch **Config** > **Threshold** in the measure dialog box to recall the threshold dialog box:

- A. Set measurement threshold source
- B. Set the type of threshold
- C. Set the upper value
- D. Set the middle value
- E. Set the lower value
- F. Return to the previous menu

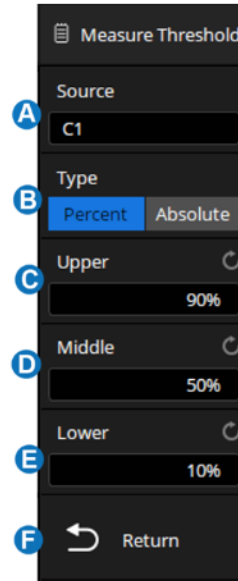

Threshold Type

Percent: Set according to the percentage of the waveform. The setting range of lower value and upper value is 1% ~ 99%, and the low value shall not be greater than the middle value and high value

Absolute: Set according to the vertical range. The absolute threshold value depends on the vertical scale, offset and probe attenuation. These values should be set before setting absolute thresholds. Lower and upper values are limited to the range of the screen. If any absolute threshold is greater or less than the minimum or maximum waveform value, the measurement may be invalid.

19.13 Hardware Frequency Counter

The hardware frequency counter is a stand-alone, hardware-based frequency measurement function. Differing from the “Frequency” parameter (see section “Horizontal Measurement”) which is measured by software, the hardware frequency counter directly uses the trigger signal as the input of a hardware counter, which yields 7-digit frequency measurement accuracy. The accuracy of the “Frequency” parameter measured by software is relative to the sample rate. The lower the sample rate, the worse the accuracy. In situations where the sample rate is less than 2 times the input frequency, the results will be incorrect. The hardware frequency counter does not have this limitation. Its result is always shown at the top-right of the display as shown below:

SIGLENT Trig'd
f(C1) = 499.9841Hz

20 Math

20.1 Overview

The SDS3000X HD supports 4 math traces and multiple operators. Arithmetic operators: Addition (+), subtraction (-), multiplication (x), division (/), average, ERES, identity, negation, maxhold, minhold; Algebra operators: differential (d/dt), integral ($\int dt$), square root ($\sqrt{\quad}$), absolute (|y|), sign, exp, ln, interpolate; and FFT, as well as a formula editor. The math traces are labeled with icons "F1 ~ F4" and can be measured by the cursors or as the source of auto measurement.

Press the **MATH** button on the front panel, or touch **+** in the channel descriptor box region and select F1~ F4, and then the math dialog box pops up.

- A. Select the math trace, F1-F4
- B. Turn on or off the math operation
- C. Select the function. Touch the area to recall the function setting page, and select the source and operator
- D. Set the vertical scale of the math operation
- E. Set the label text of the math trace
- F. Set the vertical position of the math operation. The vertical scale and position of the math can also be set by knob, referring to "Vertical Control"
- G. Enable/Disable Invert, similar to the process used in "Vertical Setup".

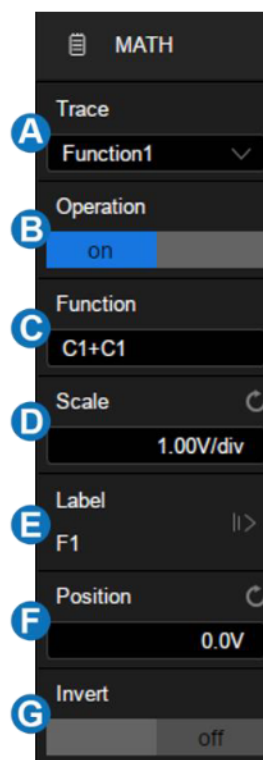

Units for Math Waveform

Different operations have different dimensions. Therefore, the specific units displayed in **Scale** depend on the operation:

| Math Operation | Unit |
|---------------------------------|---|
| Addition (+) or Subtraction (-) | V, A, or U* *(used when the units of two sources are not consistent) |
| Multiplication (x) | V ² , A ² , or W |
| Division (/) | None, Ω (Resistance unit Ohms), S (conductance unit Siemens) |
| Identity (y) or Negation (-y) | V, A |
| FFT | dBVrms, Vrms, dBArms, Arms, dBm |
| d/dt | V/s (Volt/second) or A/s (A/second) |
| $\int dt$ | VS (Volt*second) or AS (A*second) |
| $\sqrt{\quad}$ | V ^{0.5} or A ^{0.5} |
| y | V, A |
| Sign | V, A |
| Exp or Exp10 | V, A |
| Ln or lg | V, A |
| intrap | V, A |

20.2 Arithmetic

The SDS3000X HD supports Addition, Subtraction, Multiplication, Division, Average, ERES, Identity, Negation, Max-hold, and Min-hold.

20.2.1 Addition / Subtraction / Multiplication / Division

The SDS3000X HD can perform arithmetic operations including addition, subtraction, multiplication, or division on any two analog input channels, and the values of Source A and Source B are computed point-by-point.

The following figure shows an example of $F1 = C1 + C2$:

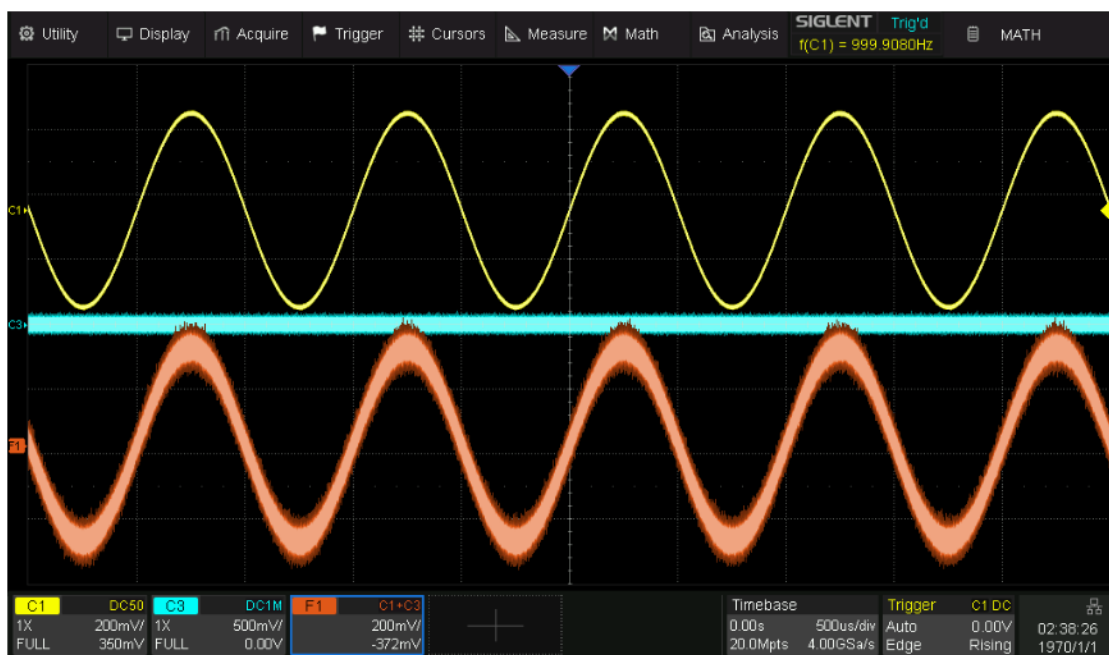

20.2.2 Identity / Negation

The values of Source A are computed point-by-point when identity or negation operation is chosen in any analog channel. The following figure shows an example of $F1 = -C1$:



20.2.3 Average / ERES

Average / ERES can be set in acquisition mode and arithmetic function as well, but with different compute methods. Average and ERES in acquisition mode is computed by hardware with a higher speed and sampling rate than computed by software in the arithmetic mode.

20.2.4 Max-hold / Min-hold

The value of Max-hold and Min-hold are based on statistical calculations from multiple frames. The following figure shows the Max-hold result.

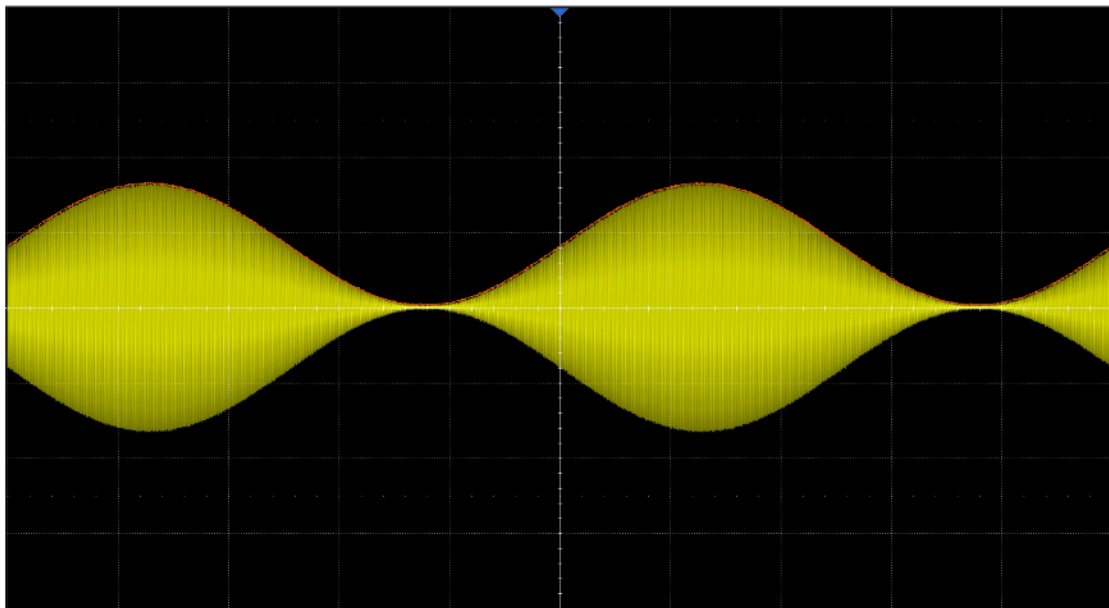

20.3 Algebra

The SDS3000X HD can perform algebraic operations including differential (d/dt), integral ($\int dt$), square root ($\sqrt{\quad}$), absolute ($|x|$), sign, exp (e^x), exp10 (10^x), ln, lg and interpolate (Intrp).

20.3.1 Differential

The differential (d/dt) operator is used to calculate the derivative of the selected source. It is always used to measure the instantaneous slope of the waveform, such as the slew rate of an operational amplifier.

The differential equation is:

$$di = \frac{y(i + dx) - y(i)}{dx}$$

Where:

d = Differential result

y = Values of source data

i = Data point index

dx = Differential interval

The range of “dx” in the d/dt menu is 1~ number of samples pts.

Note: Differentiation is sensitive to noise. It is helpful to set the acquisition mode to “Average” or “ERES” to help minimize the visible effects of additional noise.

20.3.2 Integral

Integral operation integrates the waveforms on the screen or within the specified gate.

Setting **Offset** in the integral menu provides an approach to correct the DC offset of the source. Small DC offsets in the input signal (or even small offset errors of the oscilloscope itself) may cause the integral output waveform to "ramp" up or down, as shown below:



Integral without Offset

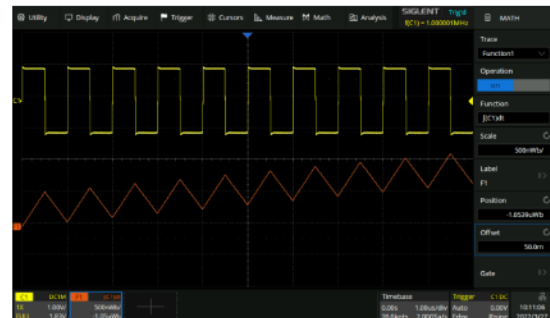

Integral with Offset

In addition, the integral operation can be performed within a specified gate. Click **Analysis** > **Analysis Gate** to enable the gate function, then set **Gate A** and **Gate B** to define the gate. See "Analysis Gate" for details.

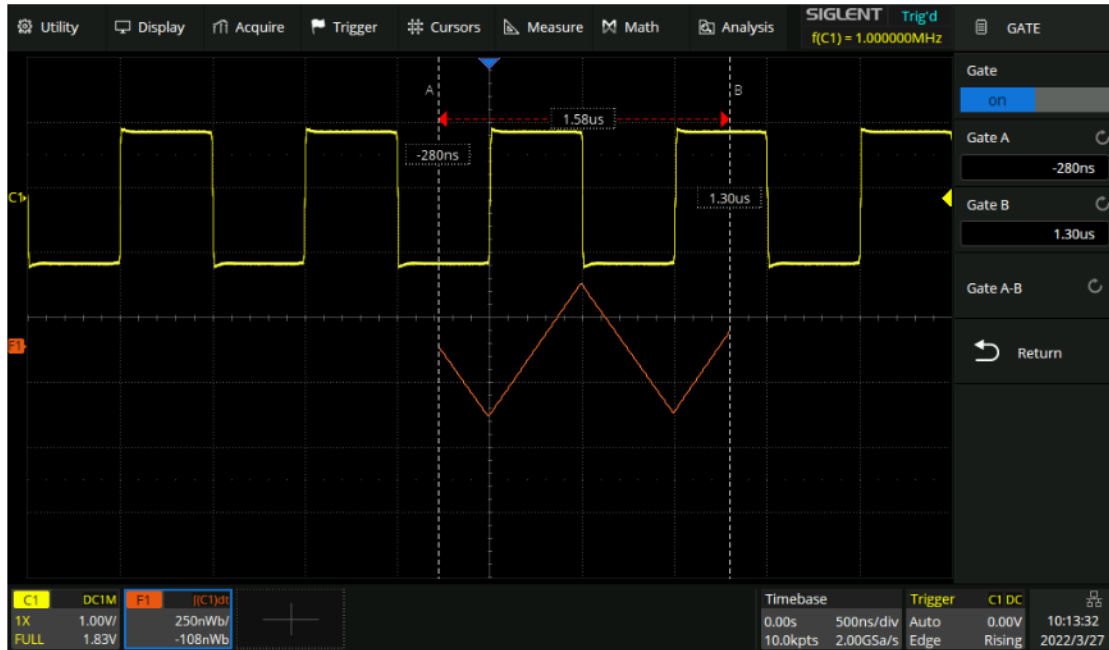

20.3.3 Square Root

Square root ($\sqrt{\quad}$) calculates the square root of the selected source. If the waveform value is negative (the waveform is below the ground level), the result is displayed as zero.

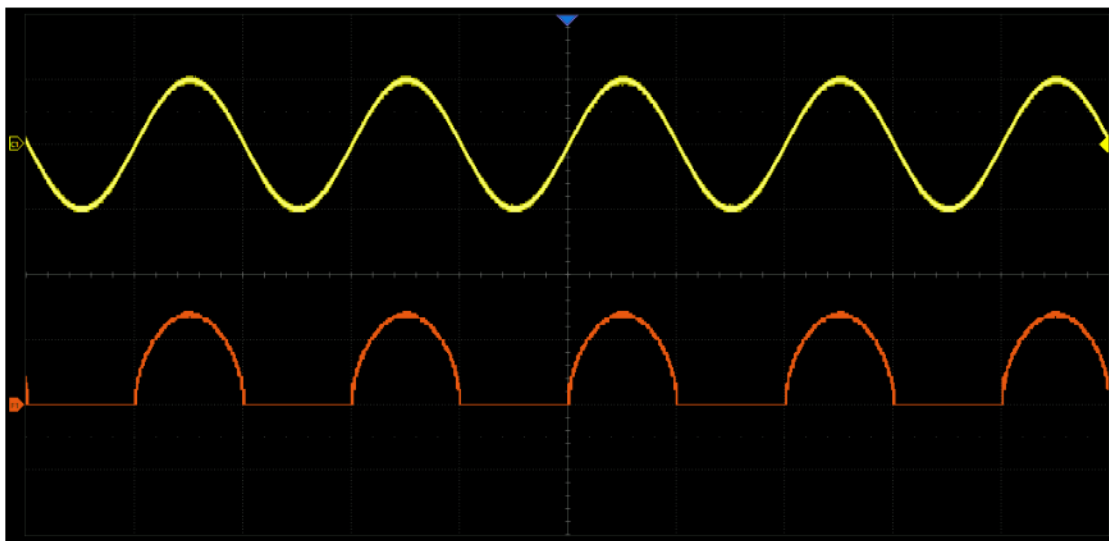

20.3.4 Absolute

Absolute ($|x|$) calculates the absolute value of the selected trace.

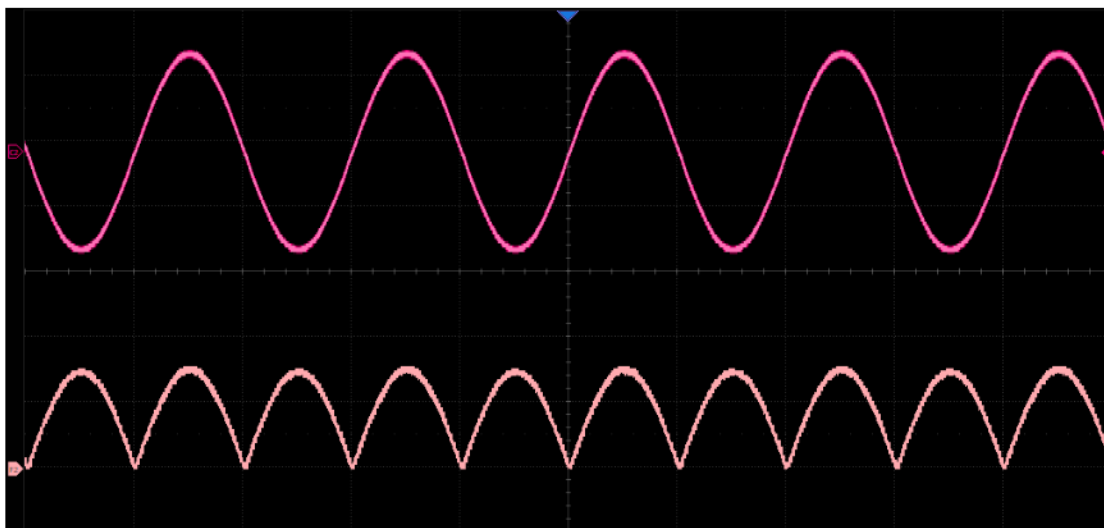

20.3.5 Sign

In mathematics, the sign function or signum function (from signum, Latin for "sign") is an odd mathematical function that extracts the sign of a real number.

The sign function of a real number x is defined as follows:

$$\begin{aligned}\text{Sign}(x) &= -1, & \text{if } x < 0; \\ &= 0, & \text{if } x = 0; \\ &= 1, & \text{if } x > 0.\end{aligned}$$

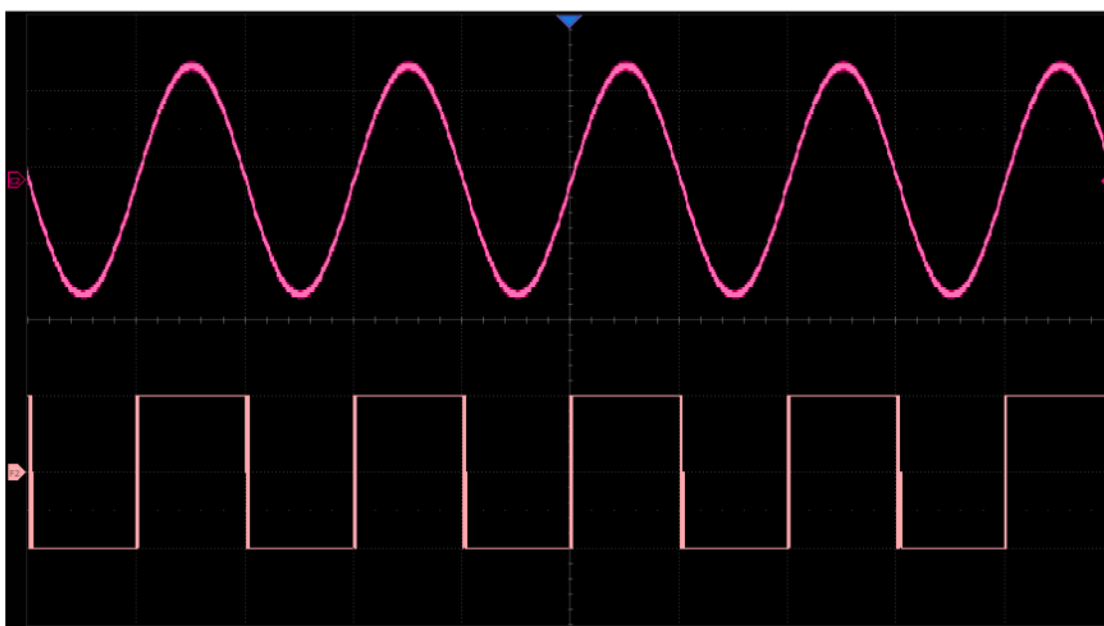

20.3.6 exp/exp10

The exponential operation includes the exponential operation e^x based on constant e and the exponential operation 10^x based on 10.

For example: $y(x) = e^x$.

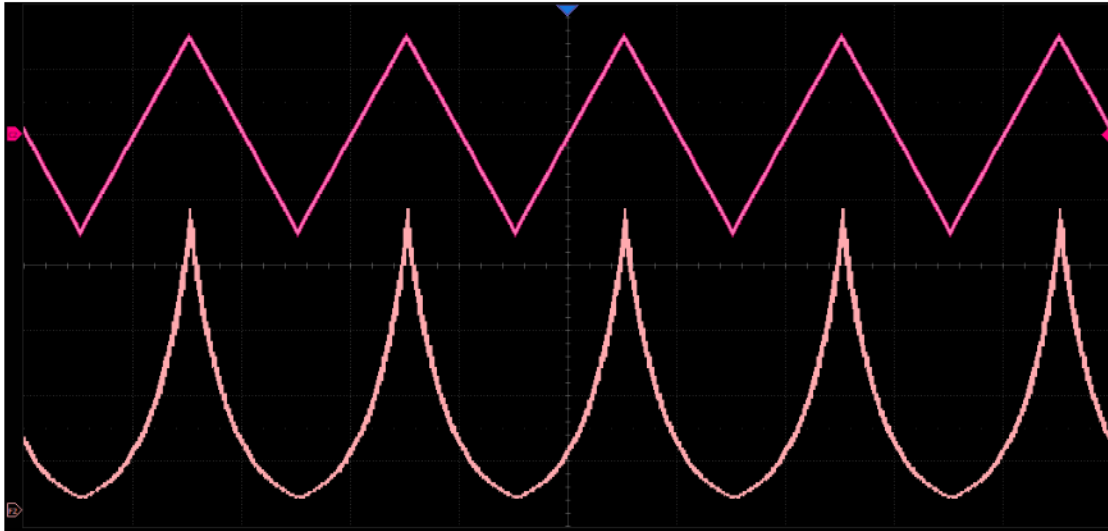

20.3.7 ln/lg

Logarithmic operation includes logarithm base e (ln) and logarithm base 10 (lg). In logarithmic operation, if the waveform value is negative (the waveform is below the ground level), the result is displayed as zero.

For example $F1 = e^x$, where x is the trigonometric wave function. $F2 = \ln(F1)$.



20.3.8 Interpolate

Between the adjacent sampling points, the waveform is interpolated according to the selected interpolation method and interpolation coefficient. Touch **Acquire** > **Interpolation** to set the interpolation method, and the interpolation coefficient can be set to 2, 5, 10, or 20.



coefficient = 2

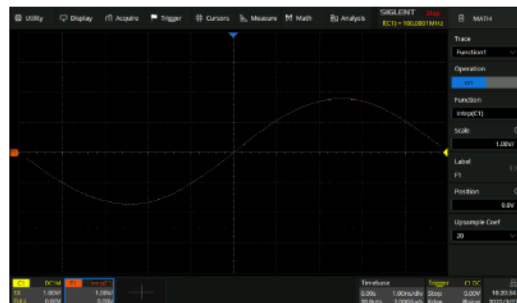

coefficient = 20

20.4 Filter

The filter operation in the SDS3000X HD provides FIR (Finite Impulse Response) filtering with the following types: Low pass, High pass, Bandpass, and Band Reject. The filters have up to 200 taps which can reach roll-off as fast as $0.01 \cdot f_s$. Users just need to set the filter type and corner frequency(s), then the instrument will automatically calculate the coefficients needed for the filtering.

- Choose to let the scope set the sample rate automatically according to the filter setting or not. See below for details
- Filter type: Low pass, High pass, Bandpass, and Band Reject
- Corner frequency. For Bandpass and Band Reject there are two corner frequencies, separately named Lower Frequency and Upper Frequency. The attenuation at the corner frequency is around 3 dB

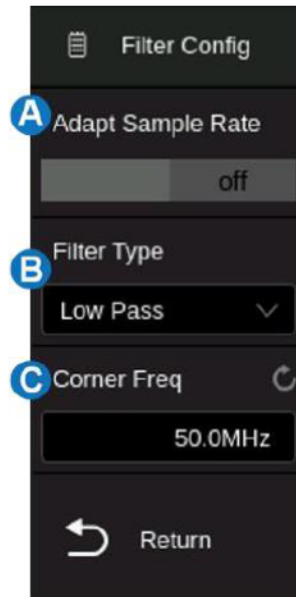

Adapt Sample Rate

Unlike an ideal “brick wall” filter, the actual FIR filters have their roll-off from the passband to the stopband because of the limited number of taps. The 200-tap FIRs applied in the SDS3000X HD provide roll-off as fast as $0.01 \cdot f_s$ (where f_s is the sample rate), this means some limitations in the setting of corner frequency at a specified sample rate. The figures below show the limitations in detail:

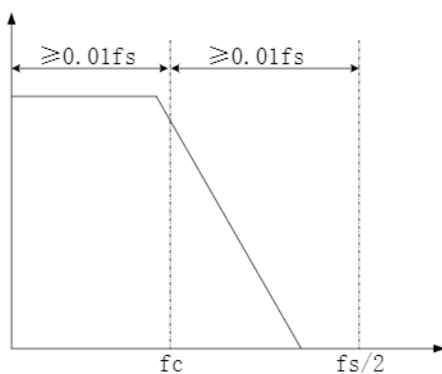

Low pass

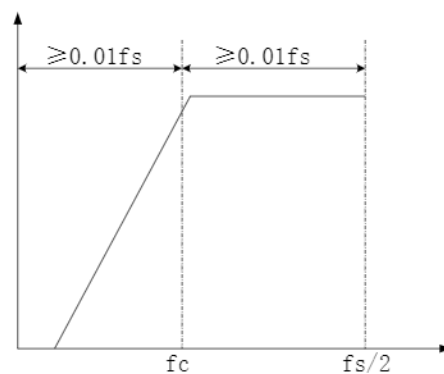

High pass

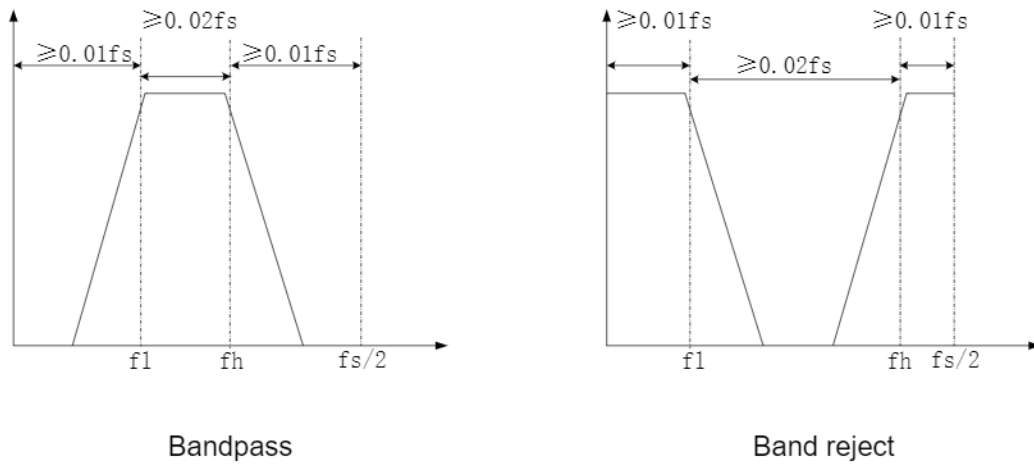

Take a Low pass filter as an example. It requires that the corner frequency (f_c) is not less than $0.01 \cdot f_s$ (i.e. $f_c \geq 0.01 \cdot f_s$), and the $0.01 \cdot f_s$ wide roll-off does not exceed the 1st Nyquist zone (i.e. $(f_s/2) - f_c \geq 0.01 f_s$). If $f_s = 4$ GSa/s, then the legal range of the corner frequency (f_c) is 40 MHz~1960 MHz

If the expected f_c is out of the legal range at some sample rate, then the sample rate needs to be changed. For instance, when $f_s = 4$ GSa/s, the setting $f_c = 10$ MHz is illegal, so we must lower f_s to 1 GSa/s to satisfy the limitation ($f_c \geq 0.01 \cdot f_s$).

Professional users who have prior knowledge of FIR filters and are familiar with the operation of this instrument are encouraged to change the sample rate for the corner frequency of interest. Otherwise, we recommend using the “Adapt Sample Rate” option. In this mode, the scope forces the Memory Management Mode to be “Fixed Sample Rate” and automatically adjusts the sample rate to adapt to the corner frequency setting. For details of the Memory Management Mode refer to the section “Memory Management”.



Note: Be aware that when the corner frequency is set very low the sample rate may not satisfy the Nyquist Theorem (i.e. f_s is no longer greater than or equal to twice the highest frequency of the input). Keep the sample rate reasonable at all times.

20.5 Frequency Analysis

The result of FFT (Fast Fourier Transform) calculations is the frequency spectrum of the source signal. The horizontal axis of the FFT display is labeled using frequency (Hz) units instead of time (seconds). In addition, the vertical axis provides the option of logarithmic scaling (dBVrms/dBArms or dBm).



- Time-domain waveform display area
- Spectrum (FFT) waveform display area
- FFT parameter display area
- Dialog box

Parameter Display Area

The FFT parameters are displayed in the upper right of the spectrum waveform display area:

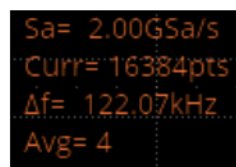

- FFT sample rate (Sa):** FFT operation results present the first Nyquist zone (DC ~ Sa/2) of the frequency spectrum. Be aware that the FFT sample rate may be inconsistent with the sample rate in the time domain. Assuming the max points value is set to 2 Mpts:
 - ✓ When the number of points in the time domain, N, is less than 2 Mpts, the FFT takes the number which is an integer power of 2 closest to N. In this case, FFT sample rate = sample rate in the time domain.

- ✓ When N is greater than 2 Mpts, FFT first decimates N by D and then takes the first 2 Mpts for the calculation. In this case, FFT sample rate = sample rate in time domain/D.
- ✓ For example, in the case of sample rate in the time domain is 2 GSa/s and the number of samples is 10 Mpts, the FFT first decimates the samples by 4, to 2.5 Mpts, and then takes the first 2 Mpts to calculate the spectrum. In this example, FFT sample rate = 2GSa/s ÷ 4 = 500 MSa/s.
- **FFT points (Curr):** The current FFT points, which is an integer power of 2. The SDS3000X HD supports up to 4 M points (4194304, to be exact).
- **Frequency interval (Δf):** The frequency interval between two adjacent points in the FFT sequence, which is proportional to the frequency resolution.
- **Average count of FFT (Avg):** Displayed only when the FFT mode is set to "Average", indicating the completed average count.

Select **Operation** as FFT in the math dialog box and touch **Config** to recall the configuration dialog box:

- A. Set the maximum points (2^n , $n = 10 \sim 22$)
- B. Set the window type (Rectangle, Blackman, Hanning, Hamming, and Flattop)
- C. Automatically set the horizontal axis to full span ($0 \sim f_s/2$)
- D. Automatically set the center frequency to the maximum frequency component in the previous frame
- E. Select the display mode (Split, Full Screen, and Exclusive)
- F. Select the FFT mode (Normal, Average, and Max-Hold)
- G. Set the average count in average mode
- H. Reset average
- I. Return to the previous menu

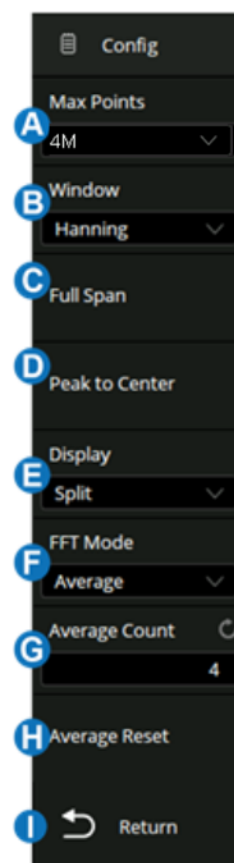

Windows

Spectral leakage in FFTs can be considerably decreased when a window is used. SDS3000X HD provides five windows that have different characteristics and apply to different scenarios.

For example, for a two-tone signal with a very close frequency interval, it is suitable to use a Rectangle window with the best frequency resolution. For the case where the accuracy of amplitude measurement is critical, it is recommended to select the Flattop window with the best amplitude resolution.

| Window | Characteristics | Main lobe width | Side lobe suppression | Maximum amplitude error |
|-----------|--|-----------------|-----------------------|-------------------------|
| Rectangle | The best frequency resolution The worst amplitude resolution It is equivalent to the case of no window | $4\pi/N$ | -13 dB | 3.9 dB |
| Hanning | Better frequency resolution Poor amplitude resolution | $8\pi/N$ | -32 dB | 1.4 dB |
| Hamming | Better frequency resolution Poor amplitude resolution | $8\pi/N$ | -43 dB | 1.8 dB |
| Blackman | Poor frequency resolution Better amplitude resolution | $12\pi/N$ | -58 dB | 1.1 dB |
| Flattop | The worst frequency resolution The best amplitude resolution | $23\pi/N$ | -93 dB | < 0.1dB |

Display Mode

- **Split:** Time-domain waveform and frequency domain waveform are displayed separately. The time-domain waveform is on the upper half screen, while the frequency domain waveform is located within the lower half of the display. In Split mode, if Zoom is enabled, the zoomed waveform and the frequency domain waveform are displayed on the lower half screen together.
- **Full Screen:** Time-domain waveform and frequency-domain waveform are displayed together.
- **Exclusive:** Only the frequency-domain waveform is displayed.

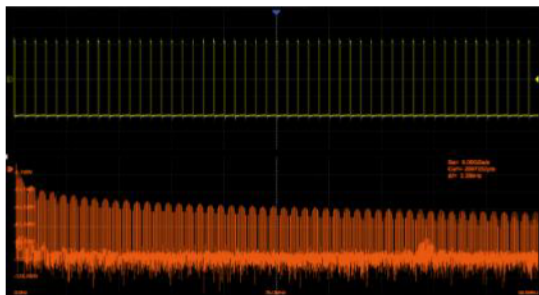

Split Mode, Zoom off

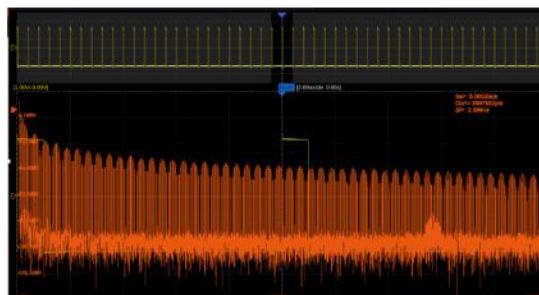

Split Mode, Zoom on

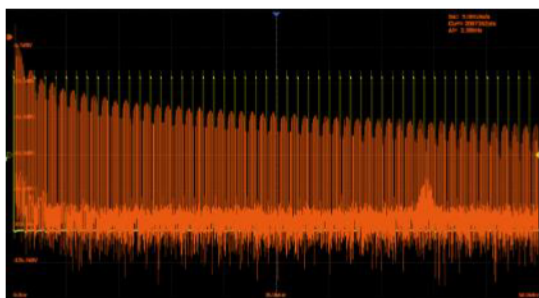

Full-Screen Mode

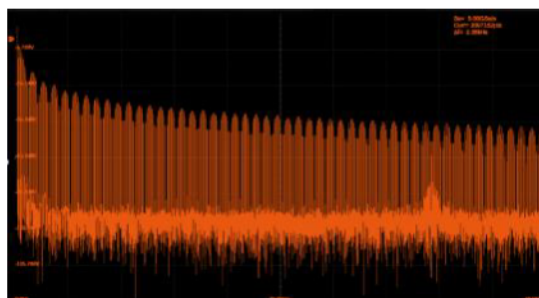

Exclusive Mode

FFT Mode

- **Normal:** Displays the FFT result of each frame directly.
- **Max-Hold:** Holds the maximum value in the historic frame on the display until cleared. This mode is suitable for detecting discontinuous waves, such as sporadic pulse signals, or frequency hopping signals. Press the **Clear Sweeps** button on the front panel to clear the max-hold waveform.
- **Average:** Reduces the effect of the superimposed random noise on the signal. After the FFT mode is set as Average, **Average** will appear under **FFT Mode**. The average count can be set here, ranging from 4 to 1024. Press the **Clear Sweeps** on the front panel or touch **Reset** in the dialog box to restart the average counter.

Touch **Vertical** or **Horizontal** in the math dialog box to recall the FFT vertical or horizontal settings dialog box:

- Set the vertical scale and reference level
- Set the unit (dBVrms, Vrms, and dBm).
- Return to the previous menu
- Set the horizontal scale, include center frequency, frequency span, starting frequency, and end frequency

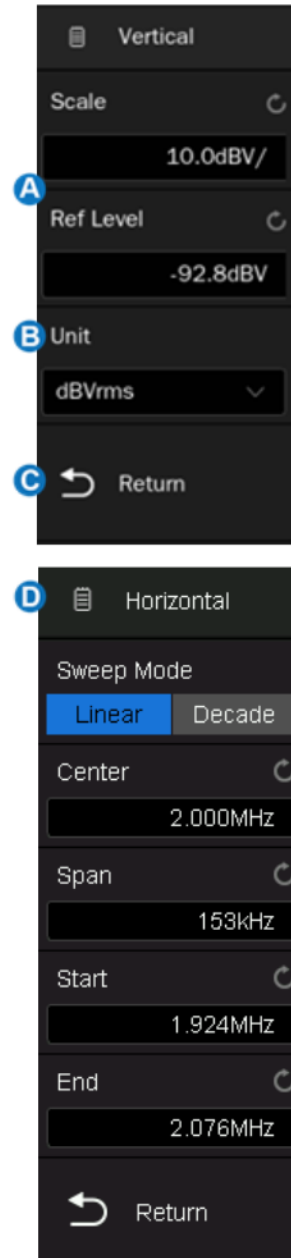

Unit

The unit of the vertical axis can be set to dBm, dBVrms, or Vrms. dBVrms and Vrms respectively using either logarithmic or linear scaling. dBVrms is recommended to show larger dynamic ranges. dBm is a power unit, the correct result can be obtained only if the value of **Ext Load** is set to be consistent with the load impedance of the actual measured signal.

Vertical Control

Touch **Ref Level** to set the reference level of the FFT waveform by the universal knob or the virtual keypad. It can also be set by the offset knob shared by Decode, Digital, Math, and Ref on the front panel.

Touch **Scale** to set the vertical scale of the FFT waveform by the universal knob or the virtual keypad. It can also be set by the scale knob shared by Decode, Digital, Math, and Ref on the front panel. The reference point for vertical scale scaling is the reference level.

Horizontal Control

Touch **Center** to set the center frequency by the universal knob or the virtual keypad.

Touch **Span** to set the frequency span with the center frequency as the center by the universal knob or the virtual keypad.

Touch **Start** to set the start frequency by the universal knob or the virtual keypad.

Touch **End** to set the end frequency by the universal knob or the virtual keypad.

The relationship between Center, Span, Start, and End is:

$$\text{Center} = (\text{Start} + \text{End})/2$$

$$\text{Span} = \text{End} - \text{Start}$$

FFT Tools

The SDS3000X HD provides two tools for the FFT waveform: Peaks and Markers. The peaks tool can automatically search the qualified peak points and mark them on the FFT waveform. Up to 10 peaks are supported. Based on the peak tool, the markers tool can automatically search the qualified harmonics, and users can control the position of each marker. Up to 8 markers are supported.

Touch **Tools** in the math dialog box to recall the FFT tools dialog box:

When the FFT tool Peaks is selected, the dialog box is as follows:

- A. Turn on or off the table. Turn on the table, the peaks searched with the limit of **D** *Search Threshold* and **E** *Search Excursion* will be displayed in a table
- B. Turn on or off the display of peak frequency in the table
- C. Sort peaks by amplitude or frequency
- D. Set the search threshold. Only peaks larger than the limit are shown
- E. Set the difference between the peak value and the minimum amplitude on both sides. The difference should be greater than the search excursion
- F. Return to the previous menu

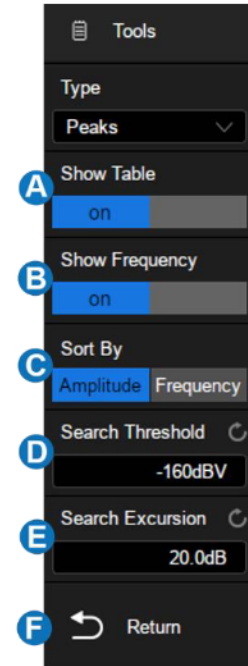

When the FFT tool Markers is selected, the dialog box is as follows:

- A. Control markers. Touch to control the display and position of each marker
- B. Marker on peaks. It will automatically mark the peak that meets the conditions of *Search Threshold* and *Search Excursion*
- C. Marker on harmonics. It will automatically mark each harmonic of the FFT waveform
- D. Turn on or off the table
- E. Turn on or off the frequency display
- F. Turn on or off the delta display
- G. Set the search threshold. Only peaks larger than the peak limit can be judged as peaks
- H. Set the difference between the peak value and the minimum amplitude on both sides. The difference should be greater than the search excursion, which can be determined as the peak
- I. Return to the previous menu

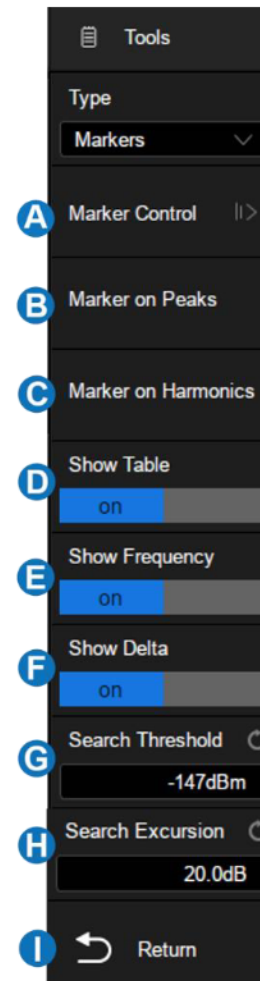

Note: The FFT dialog box is longer than the display. Slide the dialog box area up and down by gestures, or scroll the mouse wheel to the view non-displayed areas.

The following shows the peaks of the FFT waveform:

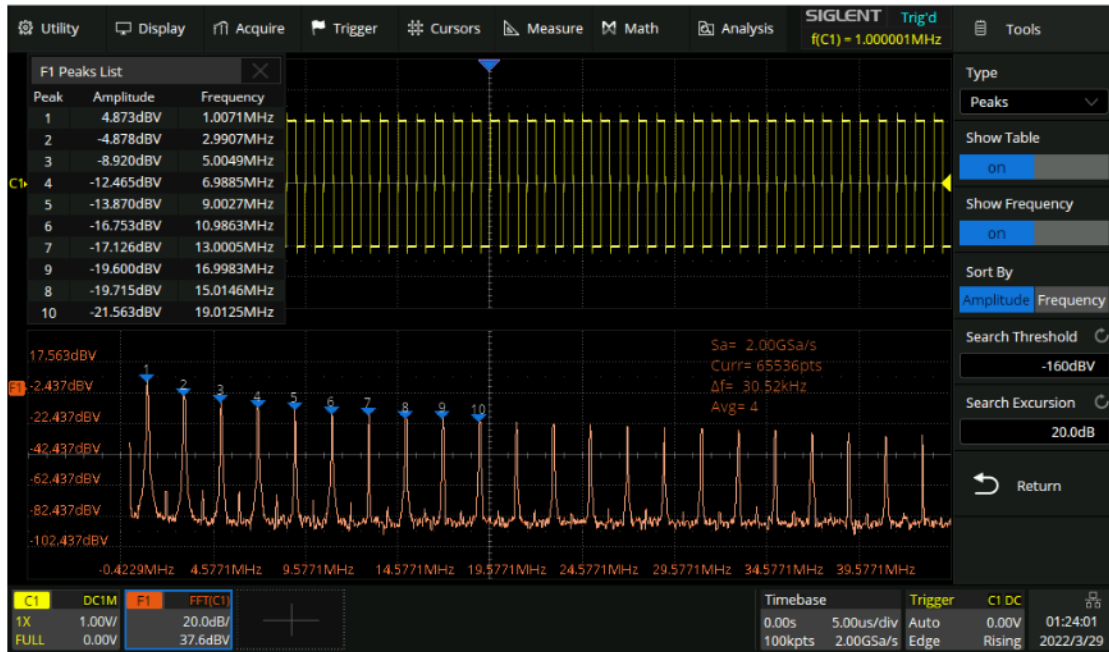

Measure the FFT waveform

Press the **Cursors** button on the front panel to turn on the cursor function, and then specify the source as "Math". X1 and X2 cursors can be used to measure the frequency value at the cursor position.

Only the maximum parameter of the FFT is supported in automatic measurement.

Note: DC components in the signal may show a large amplitude near 0 Hz. If your application does not require measurement of the DC component, it is recommended to set the coupling mode of the source channel to "AC".

20.6 Formula Editor

Touch **Formula Editor** in the operation setting page to recall the editor:

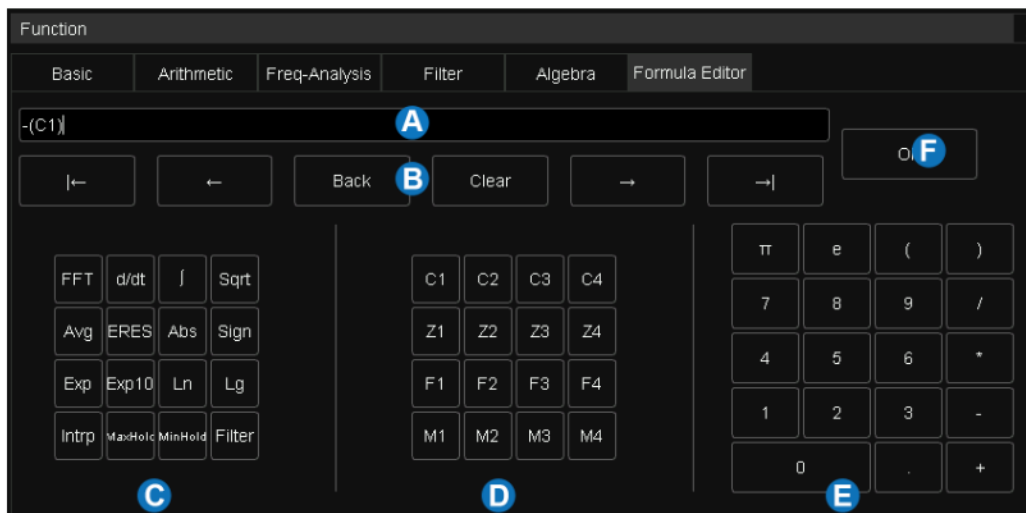

- Formula display text box
- Text box operation area, which can clear and modify the entered formula
- Special operators
- Operation source. Cx represents analog trace, Zx represents zoomed trace and Fx represents math trace
- The keyboard area contains the basic arithmetic operators addition (+), subtraction (-), multiplication (*), division (/)
- Confirm button. After the formula is input, press the button to apply it

The following is an example of $F1 = (C1 + C3) / 2$ through the formula editor

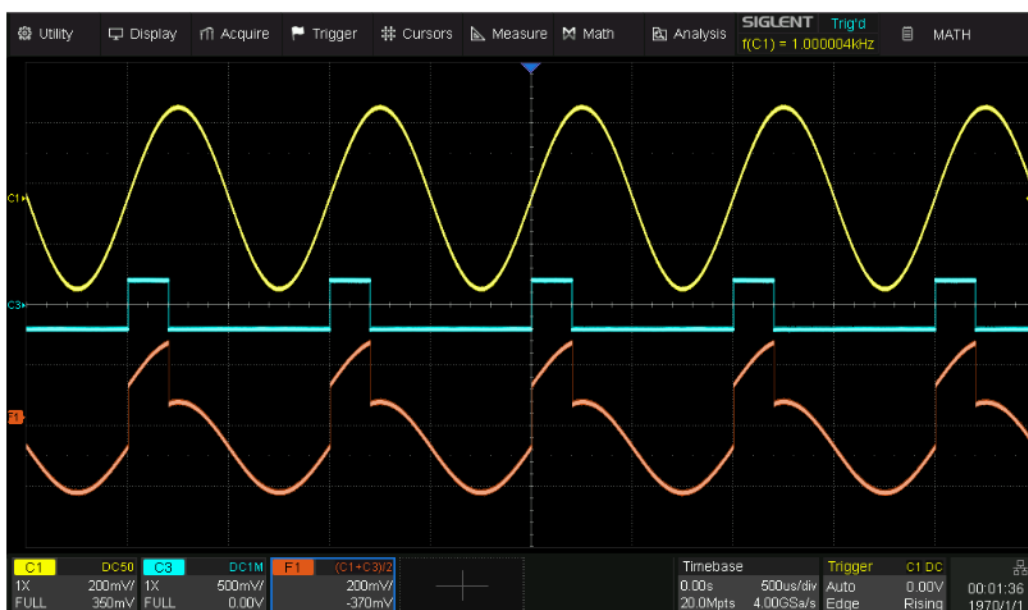

21 Memory

Analog channels (Cx), zoom (Zx), math (Fx), memory waveforms (Mx), and waveforms in files can be imported to available memory waveforms (M1/M2/M3/M4) and displayed on the screen for comparison with the current waveforms. Differing from reference traces which are displayed data, the memory traces are in the format of raw data, which can be used as the source of Math and Decoding functions and can provide more accurate measurements than a reference waveform.



- Channel waveform
- Memory waveform
- Memory vertical and horizontal information display area
- The Memory dialog box, hidden in this figure

There are multiple ways to import waveforms to memory. To enter the memory dialog box:

- Click **+** at the bottom and select **M1 ~ M4**.
- Click the menu **Utility > Save/Recall** to open the Save/Recall dialog box, select Mode as "Save", and Type as "To Memory".
- Click the menu **Utility > Save/Recall** to open the Save/Recall dialog box, select Mode as "Recall", Type as "Waveform", and then import the file to memory.
Memory to recall the ref dialog box.

Details of the dialog box are as below.

- A. Select the location of the memory (M1 ~ M4)
- B. Select the source (Cx / Zx / Fx / Mx / File)
- C. Import the trace of the selected source in **B** to the location set in **A**
- D. Turn on or off the Memory
- E. Set waveform visible/hidden
- F. Set the label text of the memory trace
- G. Set the vertical parameters of the memory trace
- H. Set the horizontal parameters of the memory trace
- I. Display the memory information, including source, vertical and horizontal parameters, sampling rate, and length

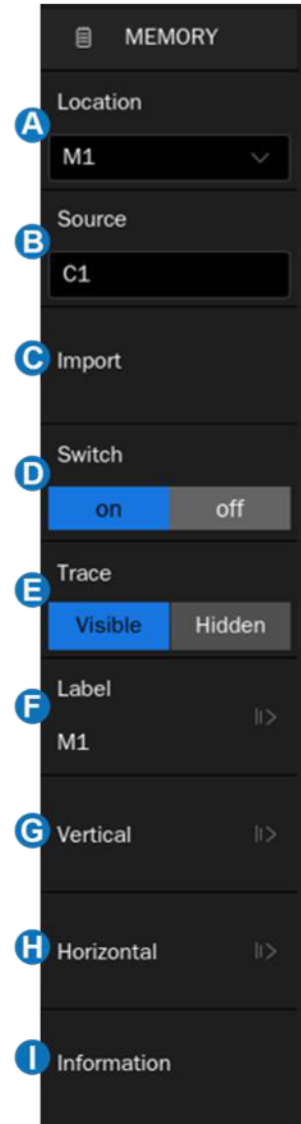

Adjust the Memory Waveform

There are a couple of ways to adjust the memory waveform:

- Adjust the parameters in the descriptor box of Mx at the bottom of the display
- Adjust the parameters in the Memory dialog.

In the **Horizontal** menu, when **Sync with Window** option is enabled, the horizontal parameters of the memory trace and analog traces are adjusted synchronously, otherwise, they are adjusted separately.

22 Analysis Gate

22.1 Overview

SDS3000X HD supports analysis gate and can perform measurement, mathematical operations, decoding, and other analysis functions on waveforms within the gate. Users can manually open the analysis gate based on actual testing scenarios. It should be noted that when the storage depth is greater than 40Mpts, the analysis gate will be automatically opened and cannot be manually closed at this time.

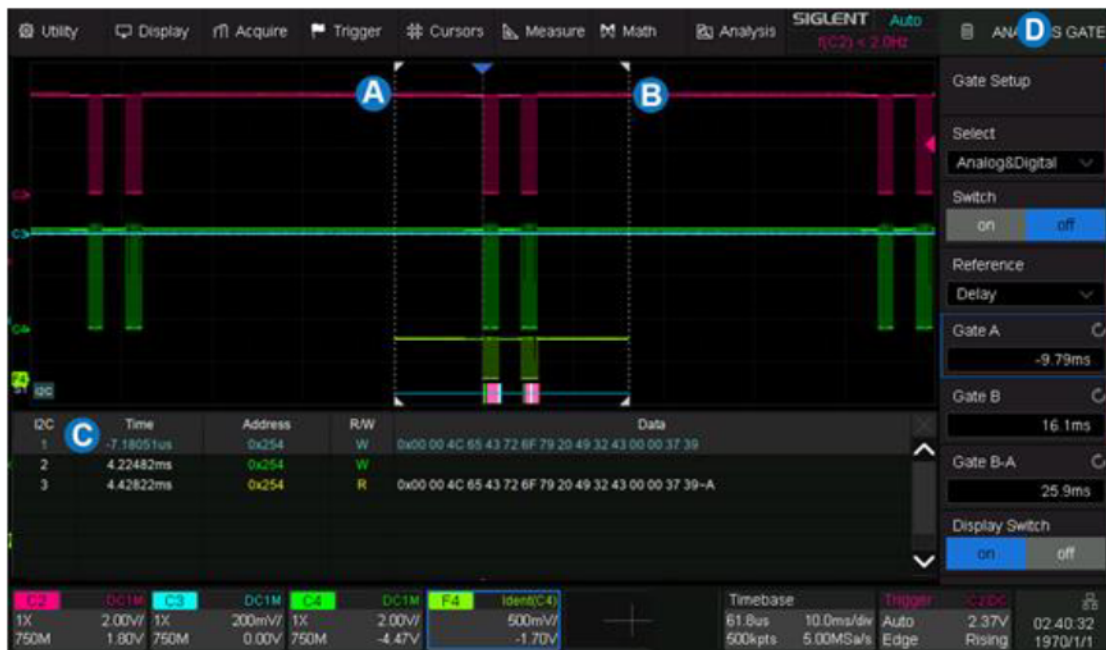

- Analysis gate cursor A. The cursor name is displayed after the gate is switched or moved, and it will be automatically hidden if there is no action after 3 seconds
- Analysis gate cursor B
- The result of analysis gate. The figure takes mathematical operation and decoding as an example
- Analysis gate dialog box

The descriptions of the analysis gate dialog box are as follows:

- A. Open the gate setup interface
- B. Select the source (Analog & Digital or M1-M4)
- C. Switch on/off the gate
- D. Set the reference position type of gate cursors (Delay or Position)
- E. Set the reference position of the gate cursor A
- F. Set the reference position of the gate cursor B
- G. Move the gate cursor A and cursor B simultaneously
- H. Switch on/off the display switch
- I. The maximum number of points in the waveform used for analysis, used to limit the range of analysis gate
- J. Fit the maximum number of points. When the function is switched on, the gate range is set to the maximum number of points centered on the current range
- K. Synchronize gate with other sources, and the gate position of the them will remain consistent. When the current source gate range is less than the Sync source, it will be synchronized to its maximum gate position and marked with a warning

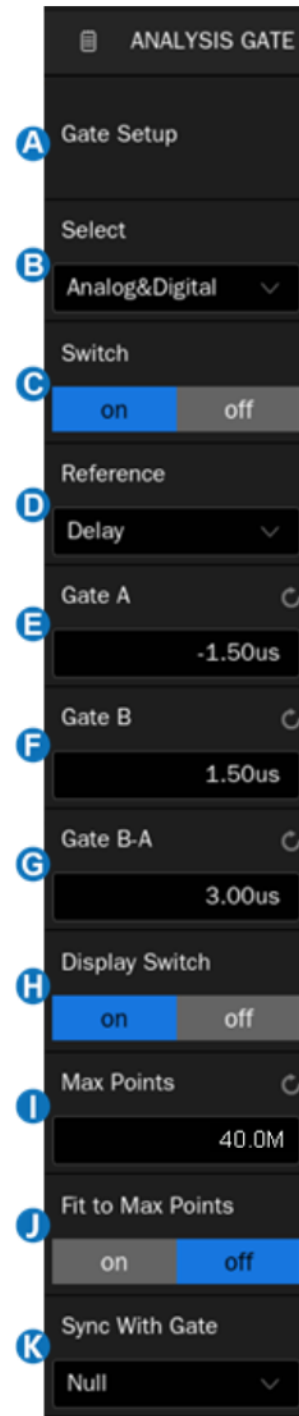

Gate Select

The Analysis Gate function can be used in analog channels, digital channels and memory waveforms (M1-M4), and the gates of each source are independent of each other. Gates of analog and digital channels are displayed as dashed white lines, and gates of memory waveforms are displayed as dashed rectangular boxes in the same color as their waveforms, as shown below:

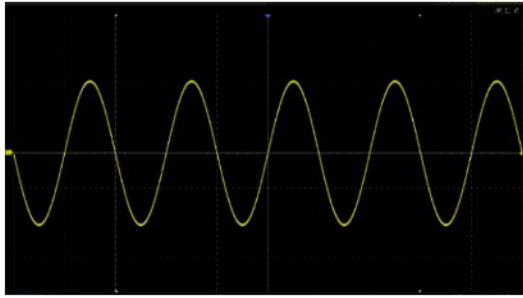

analog and digital channels

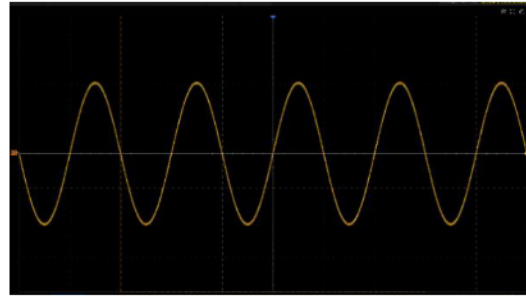

memory waveform

Gate Reference

- **Delay** -- When the horizontal scale is changed, the gate cursor value remains fixed
- **Screen position** -- When the horizontal scale is changed, the gate cursor remains fixed to the grid position on the display

22.2 Gate Setup

Click **Gate Setup** to recall the Gate Setup dialog box. The gates of multiple channels can be set at the same time, and the process of setting parameters is similar to that of setting menu bars.

Click **Select All** to select all parameters, and the same parameters for all sources can be set with one click. Click **Clear Selection** can exit the state of “Select All”.

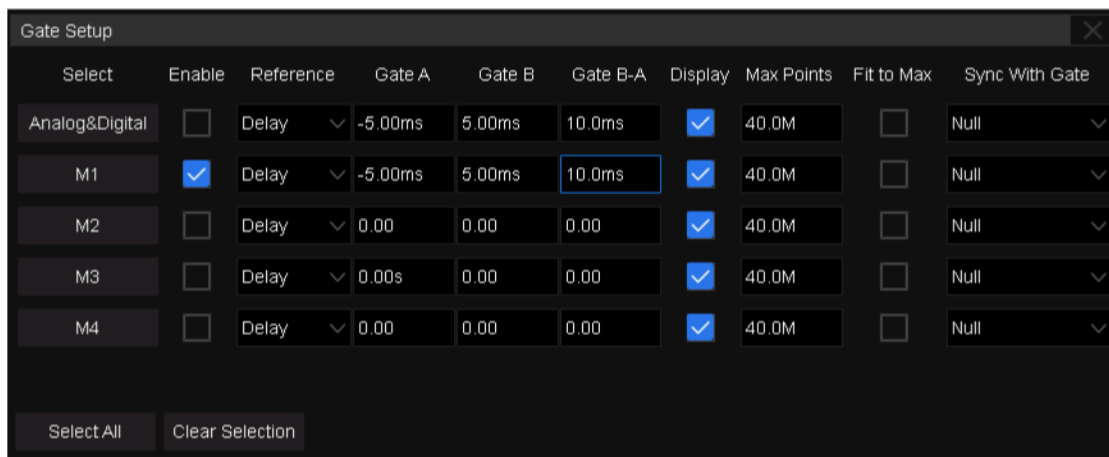

23 Search

The SDS3000X HD can search for the specified events in a frame. The location of the events is displayed with white triangle indicators. In YT mode or Roll mode with the acquisition stopped, up to 1000 events are supported. In Roll mode with the acquisition running, the number of search events is unlimited. The waveform can be zoomed in when the search function is enabled.



- A. Search event indicator, marking the time point of an event
- B. Total number of events marked on the display
- C. The search dialog box, hidden in this example

In the stop state, the area **B** shows the index of the current event/total number of events. The current event is the one in the center of the display.



Touch the menu **Analysis** > **Search** to recall the search dialog box and turn on it.

- A. Turn on/off the search function
- B. Go to the Setup Menu
- C. Synchronize the current trigger settings to the search settings.
- D. Synchronize the current search settings to the trigger settings
- E. Cancel the last synchronization and restore the settings before it.
- F. Enable the search event navigation with one key

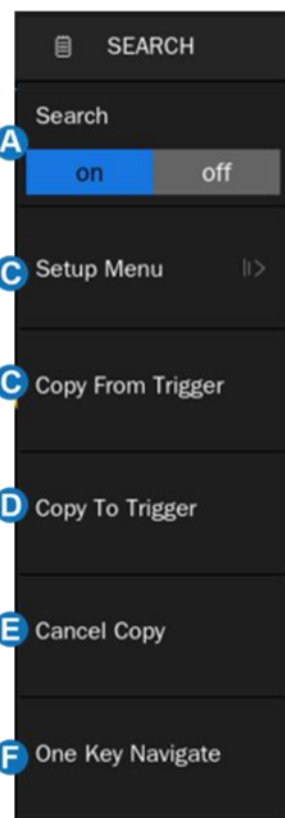

Setup Menu

Select and set the search type in the **Setup Menu**. The SDS3000X HD provides five search conditions: Edge, Slope, Pulse, Interval, and Runt.

| Search Type | Setup Description |
|-------------|--|
| Edge | Slope: Rising, Falling, Either |
| Slope | Slope: Rising, Falling Limit Range setting is available |
| Pulse | Polarity: Positive, Negative Limit Range setting is available |
| Interval | Slope: Rising, Falling Limit Range setting is available |
| Runt | Polarity: Positive, Negative Limit Range setting is available |

Search setup is similar to the corresponding trigger type. See the sections “Edge Trigger”, “Slope Trigger”, “Pulse Trigger”, “Interval Trigger” and “Runt Trigger” for details.

Copy

The SDS3000X HD supports replication between search settings and trigger settings.

- **Copy from Trigger:** Synchronize the current trigger settings to the search settings.
- **Copy to Trigger:** Synchronize the current search settings to the trigger settings.
- **Cancel Copy:** Cancel the last synchronization and restore the settings before it.

Note: When copying from the trigger, if the trigger type is not supported by Search, the operation is invalid.

24 Navigate

Touch the menu **Analysis** > **Navigate** to recall the navigate dialog box. The SDS3000X HD provides three navigate types: Search Event, Time, and History Frame.

Navigate by Time

The oscilloscope automatically adjusts the trigger delay according to the direction set by the user.

Touch **Type** in the navigate dialog box to select the navigate type as "Time". There are two ways to navigate by time:

- Touch the **Time** area to set the time value by the universal knob or the virtual keypad.
- Press the navigation buttons ◀, || or ▶ on the menu to play backward, stop, or play forward the waveform. Press the ◀ or ▶ buttons multiple times to speed up the playing. Three speed levels are supported: Low Speed, Medium Speed, and High Speed.

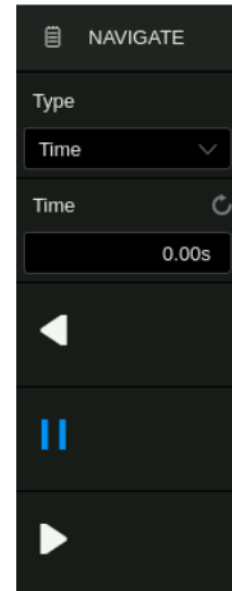

Navigate by Search Event

When the Search function is turned on and the acquisition is stopped, Navigate is usable to find search events (see the chapter "Search" for search function).

Touch **Type** in the navigate dialog box to select the navigate type as "Search Event".

Touch **Event Num** to set the event number by the universal knob or the virtual keypad. Press the navigation buttons ◀ or ▶ on the front panel to go to the previous or next search event.

Touch **Playing Mode** to set the search event playing mode.

Touch **Interval Time** to set the playing interval by the universal knob or the virtual keypad.

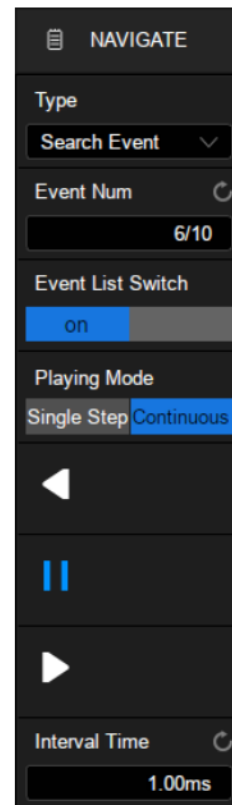

Touch the **Event List Switch** area to turn on or off the list. The list contains time labels for each event. Touching a row in the list automatically jumps to the corresponding event. This operation is equivalent to specifying an event in the **Event Num** area.



Navigate by History Frame

When the history function is turned on, Navigate can be used to play history frames (see the chapter "History" for details of the history function).

Touch **Type** in the navigate dialog box to select the navigate type as "History Frame".

Touch **Frame** to set the frame number by the universal knob or the virtual keypad. Press the navigation buttons ◀, || or ▶ on the menu to play backward, stop, or play forward.

Touch **Playing Mode** to set the search event playing mode.

Touch **Interval Time** to set the playing interval by the universal knob or the virtual keypad.

Touch **Stop On Search Event** to set the stop play condition: stop when the event is searched. This setting is only valid when the search function is on.



The following is an example of an occasional runt signal to demonstrate how to quickly locate and find events of interest by using the combination of Search and Navigate:

The input signal is a 5 V periodic square wave, in which every 200 ms there is a dwarf pulse with a height of 1/3 of the normal amplitude:

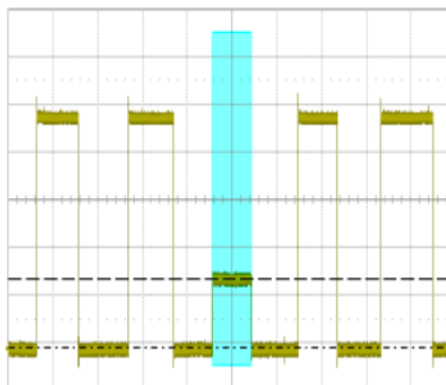

First, set the trigger type to Runt to trigger on the dwarf pulse. See the section “Runt Trigger” for details.



Then turn on the Search function and operate **Copy from Trigger** in the search dialog box so that the oscilloscope searches for the dwarf pulses according to the same setting as the trigger.

Set the horizontal scale to 10 ms/div, then 9 markers with ~10 ms interval are shown on the display, indicating that a total of 9 dwarf pulses were found in the full screen of 100 ms time range:

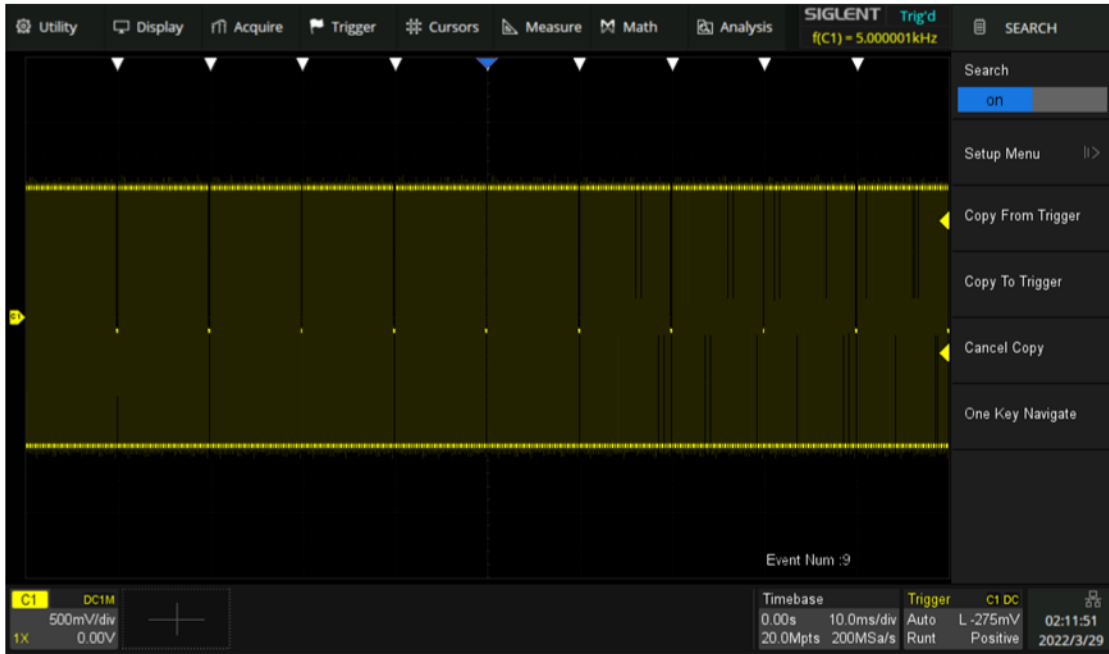

Turn on the Zoom function to observe the full view of the frame and the detail of the third dwarf pulse at the same time:

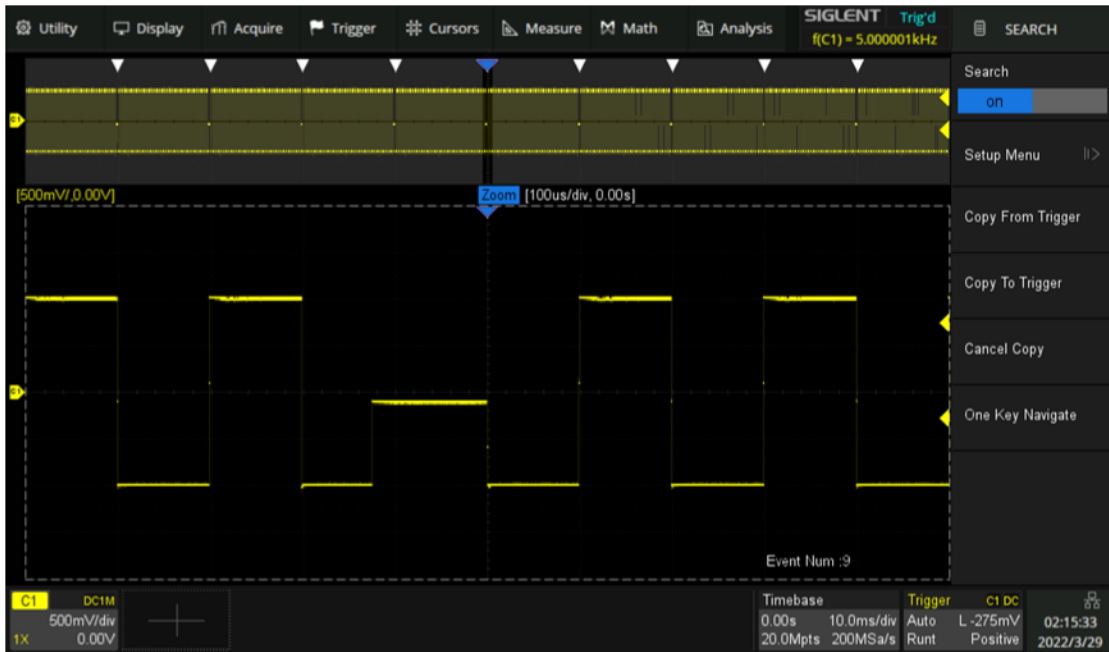

Press the **Run/Stop** button on the front panel to stop the acquisition, and then follow the steps **Navigate** > **Type** to select “Search Event”. The following figure shows the first dwarf pulse. In this example, the list is enabled and the time labels of a partial event are shown in the list.

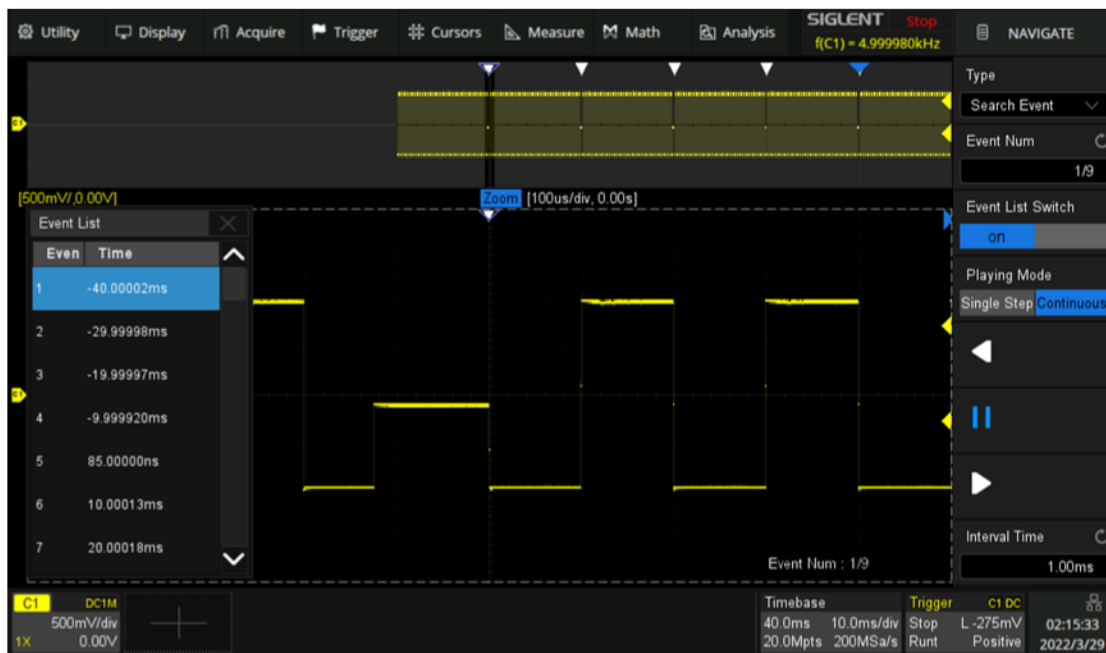

25 Mask Test

25.1 Overview

Users can create masks and define the rule used to evaluate Pass/Fail operations. An event violating the rule is defined as a failure and a pulse can be generated from the "Aux Out" port on the back panel. This is very useful to find and quantify anomalies in production tests or similar batch measurements. When Pass/Fail is enabled, the signal output from the **Aux Out** is automatically switched to Pass/Fail pulse.



- A. Mask area in green. Any dot violating the rule is highlighted in red, instead of the normal waveform color.
- B. Pass/Fail information display area, including the count of passed frames, failed frames, total frames, and the fail rate.
- C. Dialog box

Perform **Analysis** > **Mask Test** to open the Mask Test dialog box:

- A. Turn on/off the test
- B. Select the source (C1~C4)
- C. Select the rule (All In, All Out, Any In, and Any Out)
- D. Set the mask
- E. Turn on/off the Pass/Fail operation. Turning off the operation when the test is in progress will stop the test immediately, and the counters in the information display area will stop. Turning on the operation again re-starts the test and all the counters are cleared. Pressing the **Clear Sweeps** button on the front panel is equivalent.
- F. Turn on/off the information display
- G. Turn on/off "Stop on Fail". When it is "on", the oscilloscope stops the acquisition once it detects a failure
- H. Turn on/off "Failure to History". When it is "on", the failure frame will be stored internally and can be viewed through the history function
- I. Turn on/off "Capture on Fail". When it is "on", the failure waveform is detected, and the screenshot with the failure frame will be stored in the external U disk.
- J. Turn on/off the sound prompt when a failure occurs.

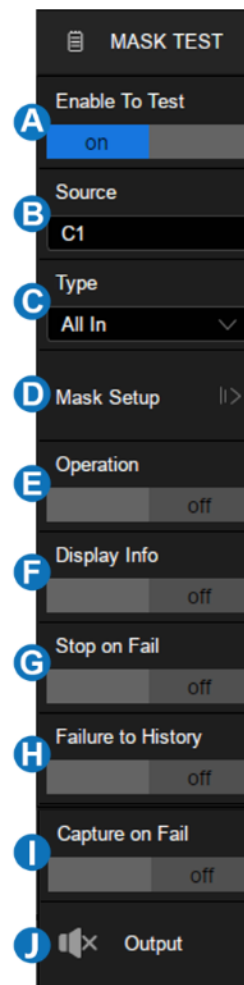

25.2 Mask Setup

Touch **Mask Setup** in the Mask Test dialog box to set the mask. There are two methods to create a mask, one is by setting horizontal and vertical values, and the other is by drawing a polygon mask.

- A. Create a mask automatically according to the waveform
- B. Create a custom mask using the Mask Editor tool
- C. Load the mask
- D. When “Auto Mask” is On, the mask grows or shrinks in proportion to the horizontal or vertical setting values. As they change, the mask adjusts to fit the new scaling values
- E. Return to the previous menu

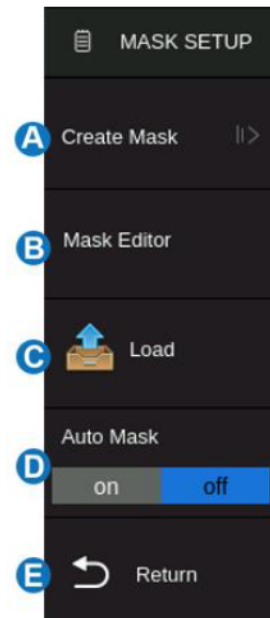

25.2.1 Create Mask

The mask can be created based on an existing waveform trace.

- A. Set the horizontal spacing of the mask around the currently displayed trace. The units are parts of the horizontal division setting.
- B. Set the vertical spacing of the mask around the currently displayed trace. The units are parts of the vertical division setting.
- C. Create the mask based on settings in **A** and **B**
- D. Save the mask
- E. Return to the previous menu

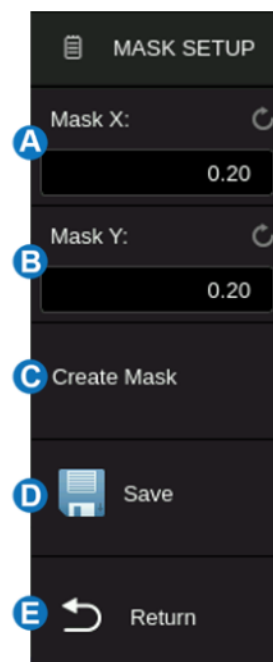

Set the values for **Mask X** and **Mask Y** (in divisions of display graticule), and then perform **Create Mask** to generate the mask. The horizontal and vertical adjustment range is 0.08~4.00 div.

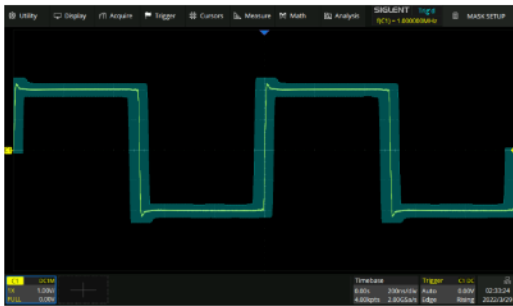

X = 0.2 div, Y = 0.2 div

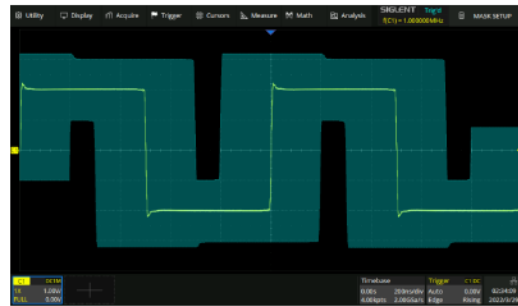

X = 1 div, Y = 1 div

Saving and recalling mask files (*.msk) is similar to the operation of setup files, see the chapter "Save/Recall" for details.

25.2.2 Mask Editor

The Mask Editor is a built-in tool that provides an approach to creating custom masks. Below is its layout:

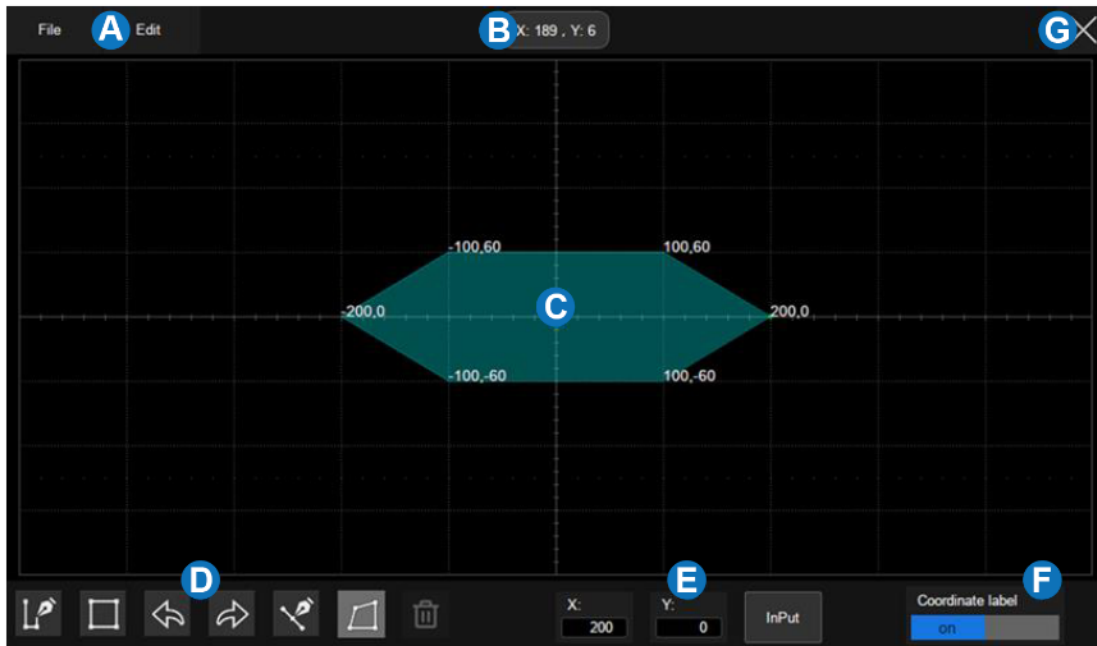

- A. Menu bar
- B. Coordinate of the latest touched point on the display
- C. Mask edit area, which is equivalent to the grid area. In this example, a hexagon has been created as a part of the mask
- D. Toolbar

- E. Coordinate edit area. Set the X ordinate and Y ordinate by the virtual keypad and then touch the “Input” button the perform the ordinate update
- F. Display or hide the coordinates of the polygon vertices on the display
- G. Exit the tool

Menu bar







There are 2 menus on the menu bar. The File menu includes ordinary file operations such as:

- **New:** Create a new mask file
- **Open:** Open an existed mask file
- **Save:** Save the current mask file
- **Exit:** Exit the Mask Editor tool

Note: The mask file created by the “Create Mask” cannot be recalled by the Mask Editor.

The contents of the Edit menu are equivalent to the Toolbar.

Toolbar

-  **Draw:** Creates vertices of a polygon by touching the display or entering values in **E** coordinate edit area
-  **Create Polygon:** Creates a polygon based on the drawn vertices by the operation Draw
-  **Undo**
-  **Redo**
-  **Insert Point:** Inserts a vertex on a selected side
-  **Edit Polygon:** Edits a polygon. Vertices, sides, and the polygon are all editable object
-  **Delete Polygon:** Deletes selected polygon

To edit a vertex, side, or polygon object, first select it, and then move it by a dragging gesture or by entering the desired value in **E** coordinate edit area. For a side, the value is for its middle point. For a polygon, the ordinate is for its geometric center.

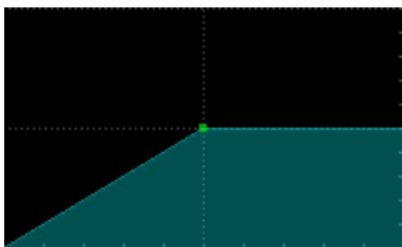

Select a vertex (point)

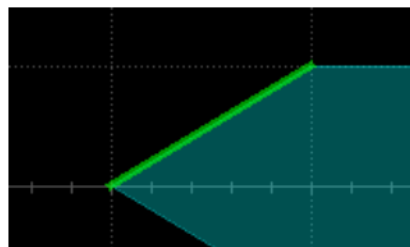

Select a side (line segment)

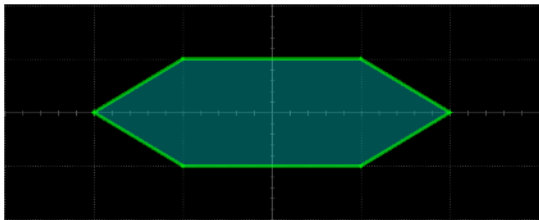

Select a polygon

25.3 Pass/Fail Rule

The Pass/Fail rule is specified at the **Type** region in the Mask Test dialog box.

- **All In:** All data points must be inside the mask to pass the test. Even a single point outside the mask will cause a failure.
- **All Out:** All data points must be outside the mask to pass the test. Even a single point inside the mask will cause a failure.
- **Any In:** Any data point inside the mask will be recognized as a pass. All data points outside the mask will cause a failure.
- **Any Out:** Any data point outside the mask will be recognized as a pass. All data points inside the mask will cause a failure.

25.4 Operation

Touch **Operation** to start/stop the test. Stopping a test in progress and restarting the test will clear the count of the passed frames, failed frames, total frames, and the fail rate. Pressing the **Clear Sweeps** button on the front panel can also clear the count information.

26 DVM

26.1 Overview

The DVM (Digital Voltage Meter) function can be used to measure parameters such as DC and AC amplitudes. The SDS3000X HD measures the specified parameter of the input signal and can display it in various formats, including Bar, Histogram, and Trend. DVM is asynchronous to the acquisition system of the oscilloscope. Sources of DVM and Measurement can be different, and DVM can work well even if the acquisition of the oscilloscope is stopped (indicated by a red-colored Run/Stop button).



- Bar display area
- Trend display area
- Histogram display area
- DVM dialog box

Touch the menu **Analysis** > **DVM** to open the DVM dialog box:

- A. Turn on or off the DVM
- B. Select the source (C1~C4)
- C. Select the Mode: DC Mean, DC RMS, AC RMS, Peak-Peak, and Amplitude
- D. Turn on or off the Auto Range
- E. Turn on or off the bar diagram
- F. Turn on or off the histogram diagram
- G. Turn on or off the trend plot
- H. Turn on or off Hold. DVM stops acquisition in Hold mode
- I. Turn on the overload alarm, an alarm will sound when the signal is out of range

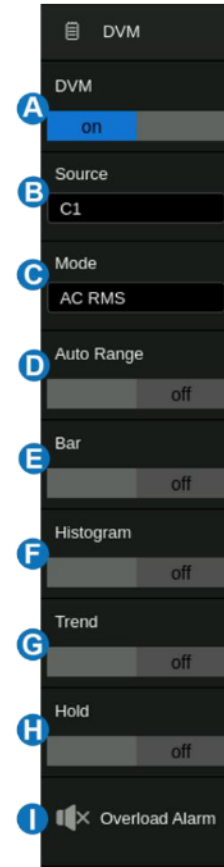

26.2 Mode

DVM provides 5 modes. Touch **mode** in the DVM dialog box to open the mode selection window:

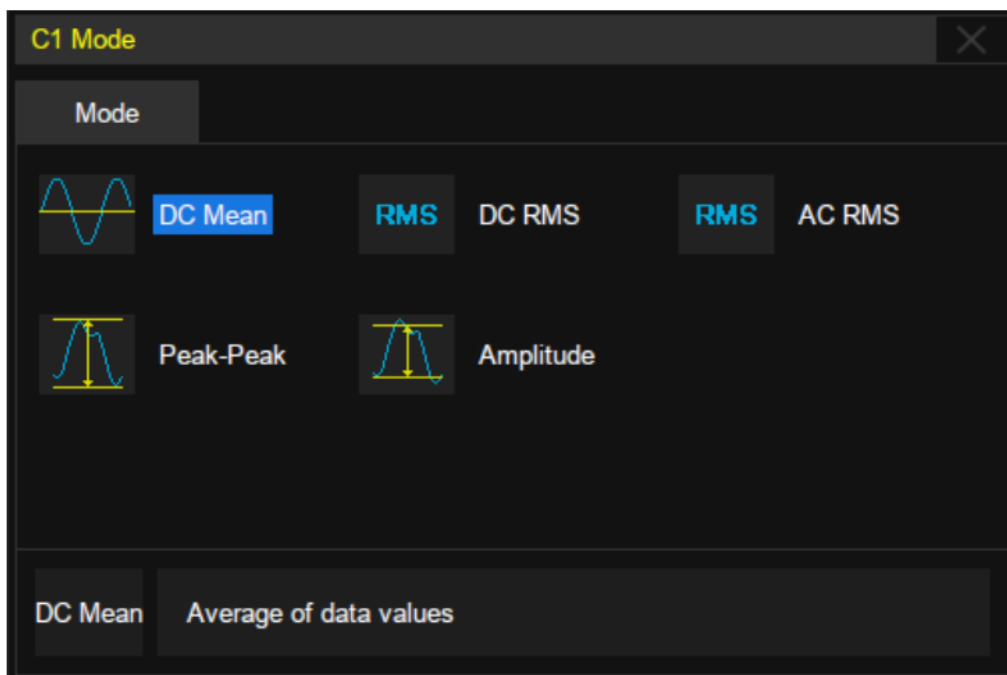

- **DC Mean:** Average of the data
- **DC RMS:** Root mean square of the data at DC coupling
- **AC RMS:** Root mean square of the data at AC coupling
- **Peak-Peak:** Difference between maximum and minimum data value
- **Amplitude:** Difference between top and base in a bimodal waveform. If not bimodal, the difference between max and min.

26.3 Diagrams

After selecting the mode, users can touch the screen to open the state diagrams: bar, histogram, and trend. The color of the data in the diagrams is consistent with the color of the source.

Bar

The bar diagram accurately displays the current measured value. Touch **Bar** in the DVM dialog box to display it.

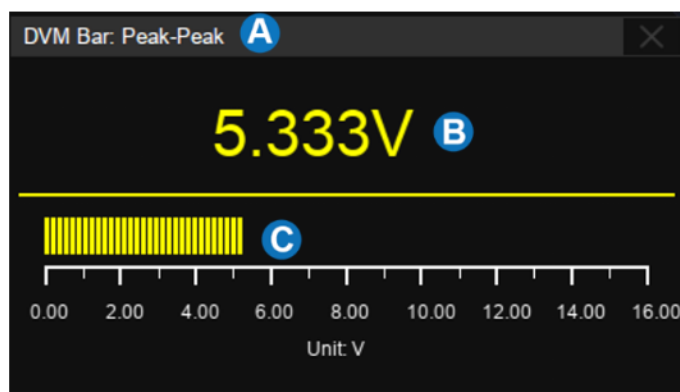

- A. Mode
- B. Current value
- C. Bar corresponding to the current value

Histogram

A histogram visually indicates the probability distribution of the measured values. Touch

Histogram in the DVM dialog box to display it.

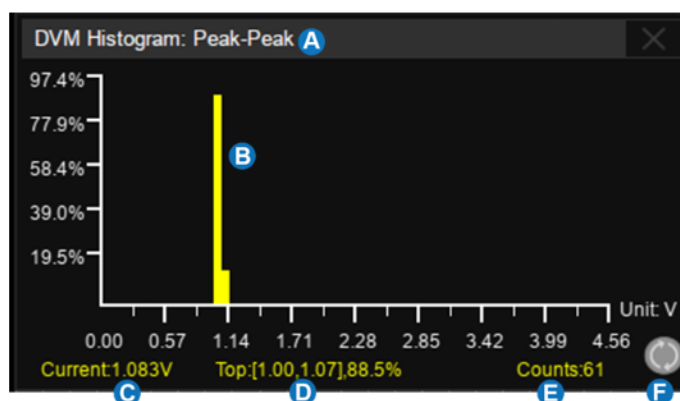

- A. Mode
- B. Histogram display area
- C. Current value
- D. The bin includes the maximum value and probability with which values fall into it
- E. Statistics counts
- F. Reset statistics

Trend

The trend diagram indicates the trend of the measured values over time. Touch **Trend** in the DVM dialog box to display it.

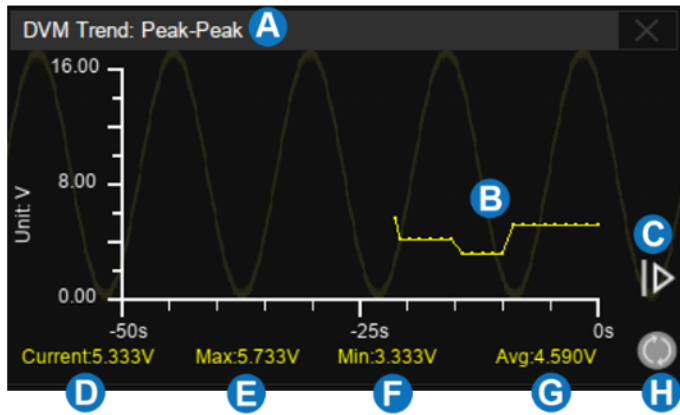

- A. Mode
- B. Trend display area
- C. Extend the range of time. Touch it to expand the time range.
- D. Current value
- E. Maximum value
- F. Minimum value
- G. Average value
- H. Reset statistics

Press the **Clear Sweeps** button on the front panel to restart counting and statistics. Touch the symbol  in the histogram and trend display areas to restart statistics.

When all the 3 diagrams are closed, there is a simple information bar on the top-left of the waveform display area to show the current value of the DVM:



27 Counter

27.1 Overview

The counter is used to measure the frequency and period of a signal or count the events happening within it. The counter is asynchronous to the acquisition system of the oscilloscope. It can work well even if the acquisition of the oscilloscope is stopped (indicated by a red-colored Run/Stop button)

Touch the menu **Analysis** > **Counter** to open the counter dialog box:

- Turn on or off Counter
- Select the mode: frequency, period, and totalizer
- Select the source (C1~C4)
- Set the level of the counter
- Turn on or off statistics
- Clear and restart the statistics. Pressing the **Clear Sweeps** button on the front panel has an equivalent effect

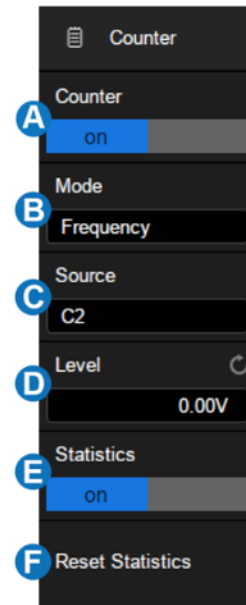

Mode

See section “Mode” for details.

Statistics

When statistics are enabled, the counter will increment the data and display the statistics results on the screen.

| | |
|---------|---------------|
| COUNTER | Frequency(C1) |
| Value | 999.9744Hz |
| Mean | 999.9914Hz |
| Min | 999.8859Hz |
| Max | 1.000105kHz |
| Stdev | 38.89054mHz |
| Count | 54 |
| Level | 0.00V |

Value -- The latest count

Mean -- The average of all historical counts

Min -- The minimum of all historical counts

Max -- The maximum of all historical counts

Stdv -- The standard deviation of all historical counts, used to judge the distribution of historical count parameters

Count -- Number of counts obtained

Level -- Counter level

Press the **Clear Sweeps** button or touch **Reset Statistics** in the measure dialog box to clear and restart statistics.

27.2 Mode

The counter provides 3 modes. Touch **Mode** in the counter dialog box to open the mode selection window:

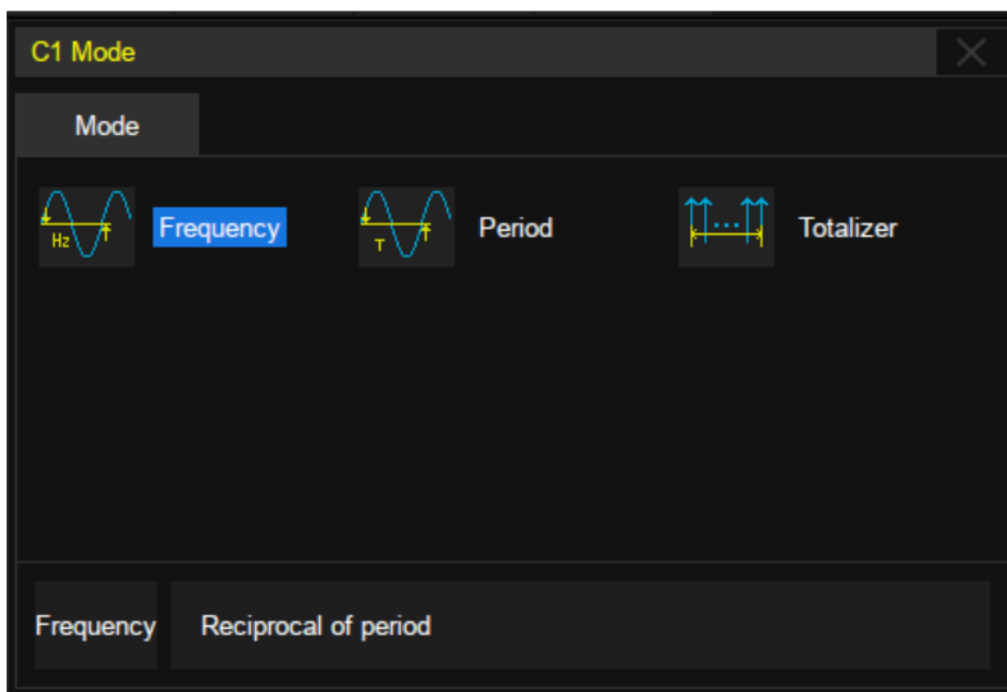

- **Frequency:** Average frequency over a set period
- **Period:** The reciprocal of the average frequency over a set period
- **Totalizer:** Cumulative count

When the mode is set to totalizer, the edge of the counting source needs to be set. When the counting gate is turned on, the counter can count only when the gate-source meets the specified conditions. Touch **Gate Setting** to recall the gate setting dialog box:

- A. Turn on or off the gate
- B. Select the gate type: Level or After Edge
- C. Gate source display area. C1 and C2 are gate sources of each other, C3 and C4 are gate sources of each other
- D. When the gate type is level, set the polarity (Positive or Negative) of the gate source. When the gate type is edge, set the slope (Rising or Falling edge) of the gate source.
- E. Set the gate level
- F. Return to the previous menu

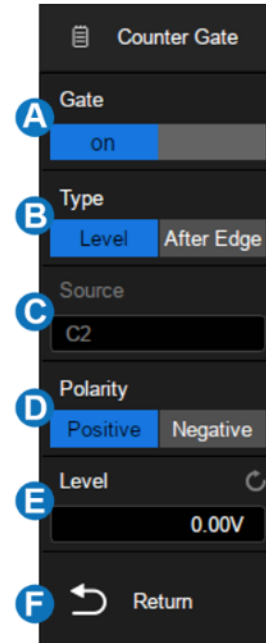

28 Histogram

28.1 Overview

The SDS3000X HD supports waveform histograms for observing probability distributions of the waveform in the specified region. The statistics can be performed in both horizontal and vertical directions. The histogram continues to update as long as the acquisition is active.

Touch **Analysis** > **Histogram** to recall Histogram dialog box:

- A. Turn on or off the histogram
- B. Select the source of the histogram: C1~C4. When Zoom is turned on, the source selection is automatically switched to Z1-Z4 (Z = Zoom waveform)
- C. Set the type of histogram: Horizontal, Vertical or Both
- D. Set the region of the histogram. The setting range is within the waveform area.
- E. Turn on or off histogram statistics
- F. Clear and restart the histogram statistics. Pressing the **Clear Sweeps** button on the front panel has an equivalent effect

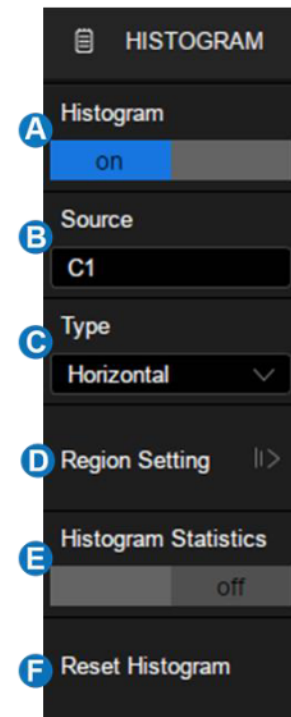

Type

- **Horizontal** -- Displays the histogram in the horizontal direction. The oscilloscope counts waveform data falling into every horizontal (time) bin defined by the histogram region and shows the histogram at the bottom of the waveform area.
- **Vertical** -- Displays histogram in the vertical direction. The oscilloscope counts waveform data falling into every vertical (amplitude) bin defined by the histogram region and shows the histogram at the left of the waveform area.
- **Both** -- Displays both horizontal and vertical histograms.

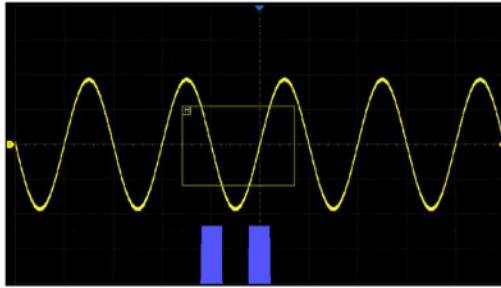

Horizontal

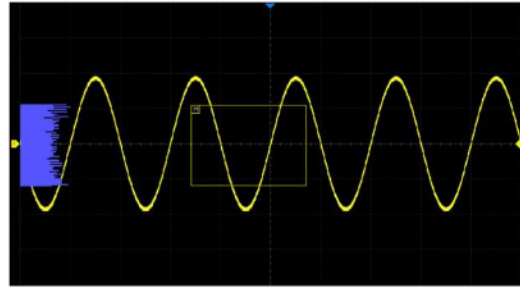

Vertical

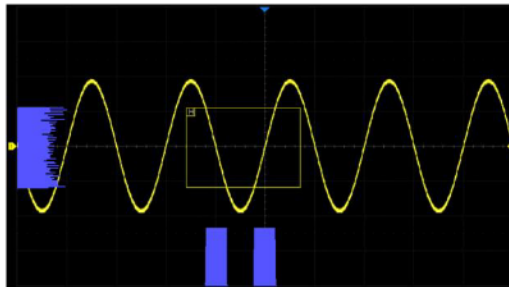

Both

Region Setting

See section “Region Setting” for details.

Histogram Statistics

When histogram statistics is turned on, the oscilloscope will show the statistical parameters of the histogram on the display.

| Histogram Statistics | | |
|----------------------|---------------|---------------|
| Type | Horizontal | Vertical |
| Sum | 26.20698Mhits | 26.20698Mhits |
| Peak | 650.0000khits | 4.247084Mhits |
| Max | 425.0000us | 833.33mV |
| Min | -80.00000us | -1.0000V |
| Pk-Pk | 505.0000us | 1.8333V |
| Mean | 88.50526us | 67.912mV |
| Median | 40.00000us | 166.67mV |
| Mode | -25.00000us | 833.33mV |
| Bin Width | 5.000000us | 166.67mV |
| Sigma | 150.8381us | 615.12mV |

Sum -- Total samples falling in the histogram region

Peak -- Samples in the highest bin

Max -- Maximum value of the samples

Min -- Minimum value of the samples

Pk-Pk -- Maximum - Minimum

Mean -- Mathematical expectation (or average) value of the samples

Median -- The value separating the higher half from the lower half of the histogram

Mode -- The value that appears most often

Bin Width -- The width of each bin

Sigma -- Standard deviation of the samples

Press the **Clear Sweeps** button or touch **Reset Histogram** in the histogram dialog box to clear and restart the statistics.

28.2 Region Setting

Histogram region can be created and moved directly by gesture or by setting **Histogram** > **Region Setting** in the dialog box. The border color of the histogram region is consistent with the color of the specified source.

Gesture

Touch any position of the waveform area and draw a rectangular box, as follow:



When the finger moves out of the touch screen, a menu pops up. Select "Histogram" in the menu:



After the region is created, it can be moved by dragging gesture.

Dialog Box

Touch **Histogram** > **Region Setting** to recall the dialog box.

- A. Set the left border of the histogram region
- B. Set the right border of the histogram region
- C. Set the top border of the histogram region
- D. Set the bottom border of the histogram region
- E. Return to the previous menu

Touch the area above to set the value by the universal knob or the virtual keypad.



29 Power Analysis

29.1 Overview

The SDS3000X HD supports a power analysis function. Power analysis can help users quickly and easily analyze and debug switching power supply design. It automatically calculates Power Quality, Current Harmonics, Inrush Current, Switching Loss, Slew Rate, Modulation, Turn On/Turn Off, Transient Response, PSRR, Power Efficiency, Output Ripple, etc. Full use of the Power analysis requires a differential voltage probe like the SIGLENT DPB series, a current probe like the SIGLENT CP series, the SIGLENT DF2001A deskew fixture, and the power analysis activation license (part number SDS3000HD-PA). Install the software option part number SDS3000HD-PA to permanently enable the power analysis function.

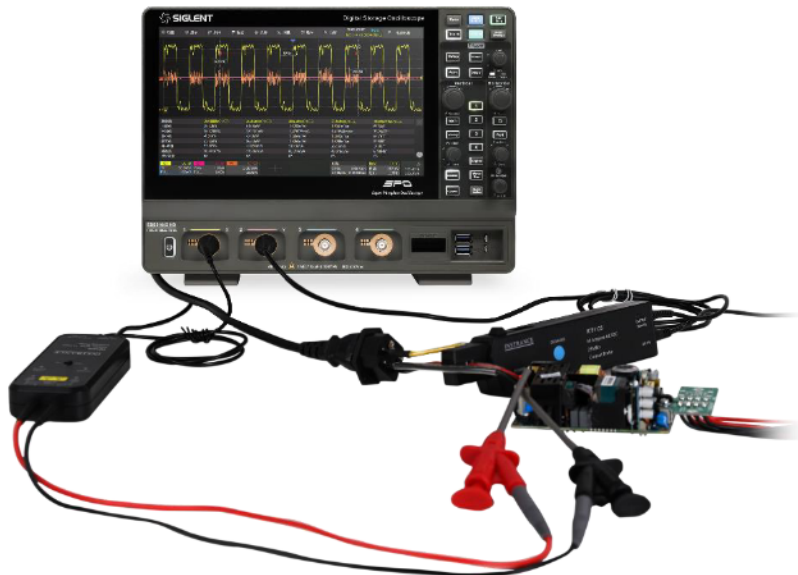

Touch **Analysis** > **Power Analysis** to recall power analysis dialog box:

- A. Enable/Disable the test
- B. Select the analysis item (Power Quality, Current Harmonics, Inrush Current, Switching Loss, Slew Rate, Modulation, Turn On/Turn Off, Transient Response, PSRR, Power Efficiency, Output Ripple, etc.)
- C. Turn on/off the state of the analysis item

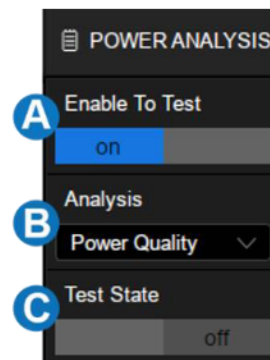

29.2 Power Quality

The specific measurement parameters of power quality analysis include active power, apparent power, reactive power, power factor, power phase angle, voltage effective value, current effective value, voltage crest factor, and current crest factor of power input of a switching power supply.

Type

Power -- Includes all the items to describe energy flow in a system: Active power, reactive power, apparent power, power factor, and power phase angle.

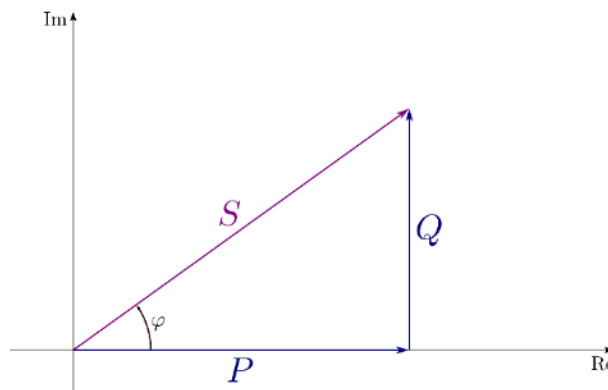

$$P: \text{Active Power} = \frac{1}{N} * \sum_{i=0}^{N-1} V_i * I_i$$

$$S: \text{Apparent Power} = V_{\text{rms}} * I_{\text{rms}}$$

$$Q: \text{Reactive Power} = \sqrt{\text{Apparent Power}^2 - \text{Active Power}^2}$$

φ : Power Phase Angle: Phase difference between voltage and current

$\cos \varphi$: Power Factor, which is the ratio of active power and apparent power.

Voltage Crest -- Voltage parameters of the power input include voltage crest, voltage effective value, and voltage crest factor.

$$V_{\text{rms}} = \frac{1}{N} * \sqrt{\sum_{i=0}^{N-1} V_i^2}$$

$$V_{\text{Crest}} = V_{\text{peak}} / V_{\text{rms}}$$

Current Crest -- Current parameters of the power input include current crest, current effective value, and current crest factor.

$$I_{\text{rms}} = \frac{1}{N} * \sqrt{\sum_{i=0}^{N-1} I_i^2}$$

$$I_{\text{Crest}} = I_{\text{peak}} / I_{\text{rms}}$$

Signal Settings

Touch **Signal** to recall signal settings dialog box:

- A. Set the input voltage source
- B. Set the input current source
- C. Set the periods displayed
- D. View the connection guide
- E. Return to the previous menu

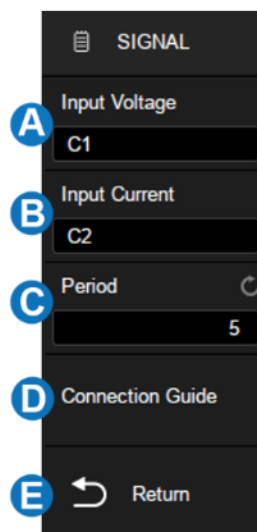

Connection Guide

Touch **Signal** > **Connection Guide** to recall the connection guide of power quality, as shown in the figure below. Please follow the instructions in this figure for correct connections. Touch the icon on the top right of the guide to close.

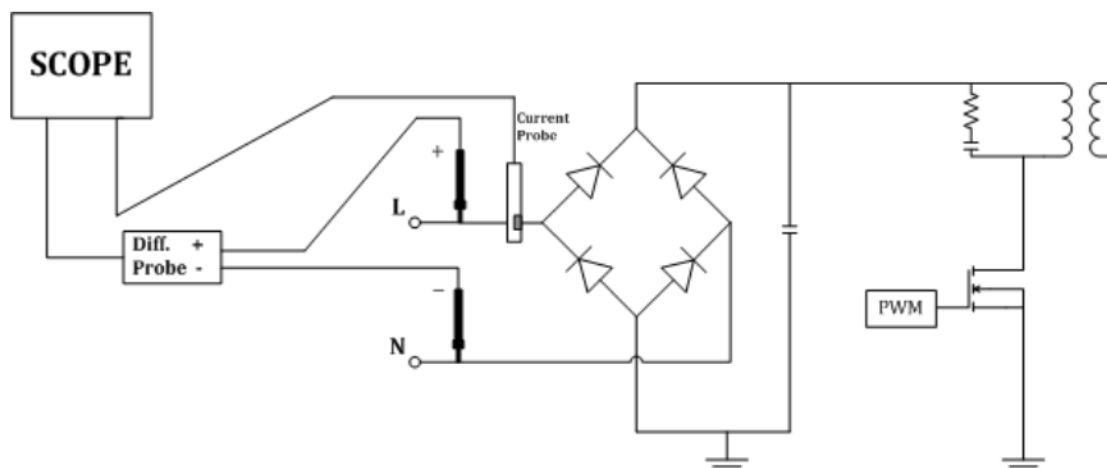

29.3 Current Harmonics

Current harmonics are used to analyze the input current harmonics. An FFT of the selected channel is performed to get the harmonic components. The signal settings and connection guide are the same as the power quality test.

Configuration

Touch **Config** to recall the configuration dialog box:

- A. Set the frequency of the line (Auto, 50 Hz, 60 Hz, or 400 Hz)
- B. Set the standard type (IEC61000-3-2 A, IEC61000-3-2 B, IEC61000-3-2 C or IEC61000-3-2 D)
- C. Set the display type (Off, Bar Chart, or Table)
- D. Return to the previous menu

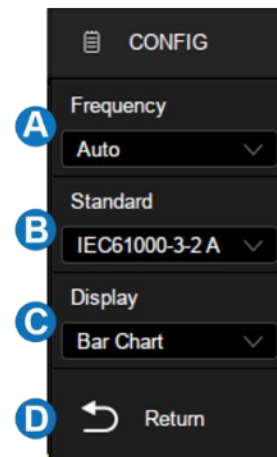

Standard

IEC 61000-3-2 is an international standard that limits mains voltage distortion by prescribing the maximum value for harmonic currents from the second harmonic up to and including the 40th harmonic current. There are 4 different classes in the EN 61000-3-2 that have different limit values:

- **Class A:** Balanced 3-phase equipment, household appliances excluding equipment identified as class D, tools, excluding portable tools, dimmers for incandescent lamps, audio equipment, and all other equipment, except that stated in one of the following classes.
- **Class B:** Portable tools, arc welding equipment which is not professional equipment
- **Class C:** Lighting equipment.
- **Class D:** PC, PC monitors, radio, or TV receivers. Input power $P \leq 600 \text{ W}$.

Parameter Description

For the first 40 harmonics, the following values are displayed:

- **Measured Value (RMS)** -- The measured value displayed in the unit specified by the harmonic unit parameter.
- **Limit Value (RMS)** -- Limits specified by the selected standard
- **Margin (%)** --The margin specified by selected standard parameters. The margin value is $(\text{standard value} - \text{measured value}) / \text{standard value} * 100\%$

- Pass/Fail State** -- Determine whether the measured value is passed or failed according to the selected standard. The rows in the table or the bars in the bar chart are rendered in different colors based on the pass / fail state. When the value is greater than 85% of the limit but less than 100% of the limit, it is defined as a critical state.

- Total Harmonic Distortion (THD)** = $100\% * \frac{\sqrt{X_2^2 + X_3^2 + \dots + X_n^2}}{X_1}$, where X_n is the nth harmonic, and X_1 is the basic component.



29.4 Inrush Current

A large current far greater than the stable current may flow through at the moment of switching on a power supply. The large current is called the inrush current. The current waveform when switching on is shown in the figure below:

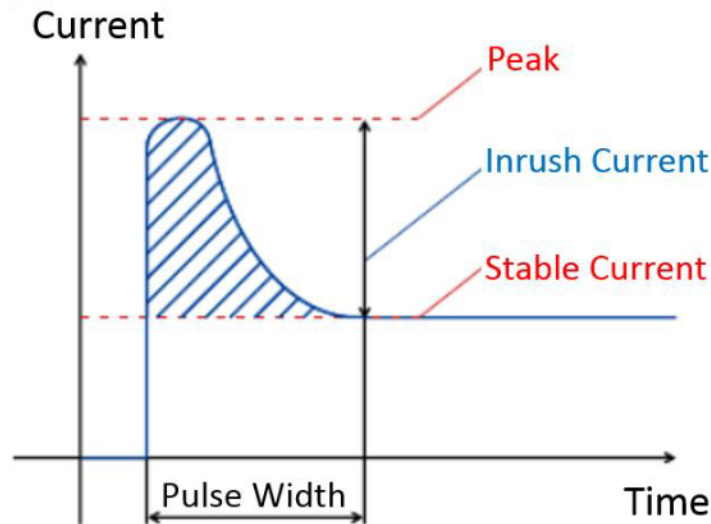

Signal Settings

Touch **Signal** to recall signal settings dialog box:

- A. Set the input voltage source
- B. Set the input current source
- C. Set the expected current value, the range is 100 mA ~ 500 A. The oscilloscope will set the trigger level to expected current/20 and the vertical scale of the current channel to expected current/3.
- D. Set the maximum effective input voltage (V_{rms}), the range is 1 V ~ 1 kV. The oscilloscope will set the vertical scale of the voltage channel to maximum input voltage/6
- E. View the connection guide
- F. Return to the previous menu

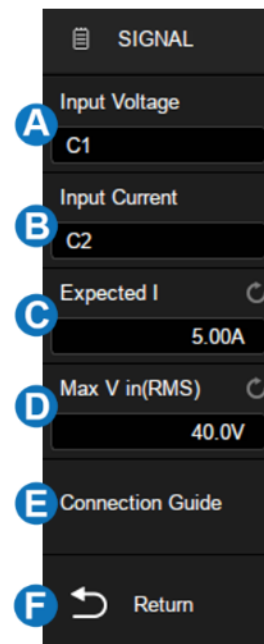

29.5 Switching Loss

Switch loss analysis can be used to calculate the power dissipated in the switching period.

Deskew Calibration

A relatively small skew can cause a large measurement error of switching loss, especially during the on phase when the voltage is close to zero and the non-on phase when the current is close to zero. This is a typical oscilloscope dynamic range limitation when trying to measure weak voltage and (or) current in the presence of relatively large switching voltage and (or) current.

To correct the skew between the oscilloscope channels or probes, the deskew procedure should be performed once initially, and re-run when any part of the hardware setup changes (for example, a different probe, different oscilloscope channel, etc.) or when the ambient temperature changes. The deskew procedures by using the DF2001A deskew fixture are as follows:

- A. Demagnetize and zero-adjust the current probe
- B. Set up connections to the DF2001A deskew fixture

| | Small Loop | Large Loop |
|--|--|---|
| Available current probes | CP4020 (100 kHz,20 Arms) CP4050 (1 MHz,50 Arms) CP4070 (150 kHz,70 Arms) CP4070A (300 kHz,70 Arms) CP5030 (50 MHz,30 Arms) CP5030 (100 MHz,30 Arms) | CP5150 (12 MHz,150 Arms) CP5500 (5 MHz,500 Arms) |
| High-voltage differential probe sense points | J7: signal terminal J6: earth terminal | J3: signal terminal J4: earth terminal |

- a) Connect D+ and D- of the high-voltage differential probe to J7 and J6
- b) Connect the current probe to the loop with the direction of the arrow indicating the direction of the current flow
- c) Make sure the switch S1 on the deskew fixture is set to the appropriate side of the fixture (either “small loop” or “large loop”)
- d) Connect the deskew fixture to a USB port on your oscilloscope or a PC using a USB cable. The USB port supplies power to the deskew fixture

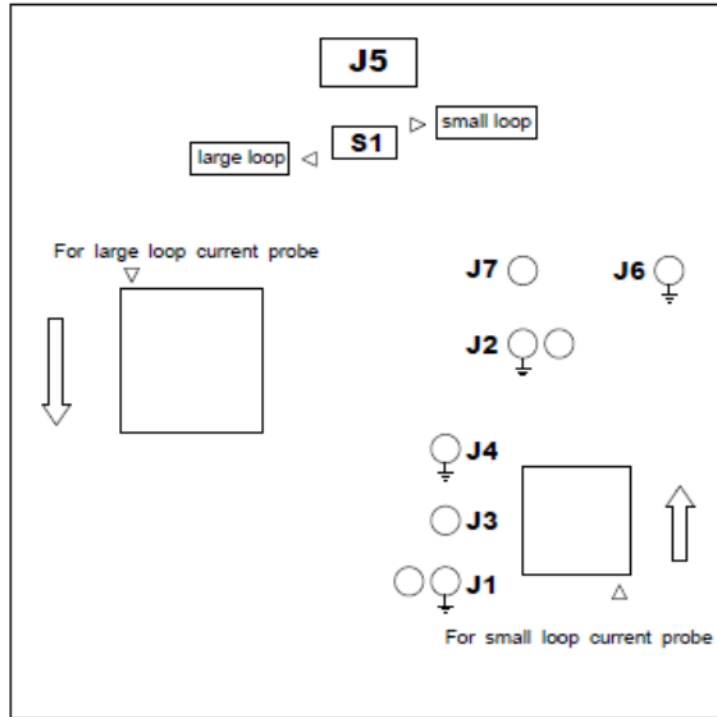

- C. Connect the voltage and current probes to the oscilloscope input channel
- D. Touch **Signal** to enter the signal setting menu. Select the corresponding input channel, and then touch **Auto Deskew** to perform the calibration. When the process completes, a message will pop up indicating whether the deskew operation was successful or not.



Before deskew calibration



After deskew calibration

Configuration

Touch **Config** to recall the configuration dialog box:

- A. Set the voltage reference, i.e. the switch level at the edge of the input switch. This value is a percentage of the maximum switching voltage. Adjusting the value to ignore background noise. This value is used to determine the threshold hysteresis of the switch edge
- B. Set the current reference, i.e. the switch level at the beginning of the input switch edge. This value is the percentage of the maximum switching current. This value can be adjusted to ignore background noise or invalid offset that is difficult to eliminate in the current probe. This value is used to determine the threshold hysteresis of the switch edge
- C. Set the conduction type (Waveform, Rds(on) or Vce(sat))
- D. Set Rds(on) resistance
- E. Set Vce voltage
- F. Return to the previous menu

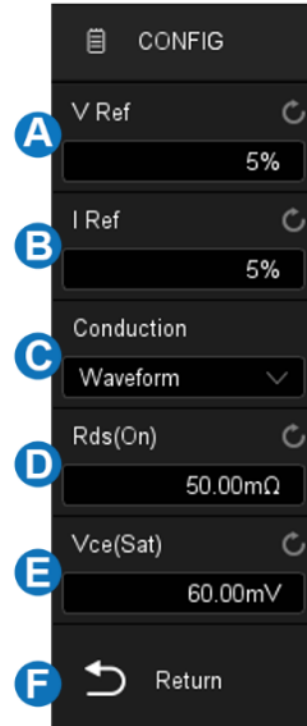

Conduction Type

- **Waveform** -- The power waveform uses the original data, and the calculation formula is $P = V * I$, $E = P * T$.
- **Rds (on)** -- In the on area (where the voltage level is lower than the voltage reference (adjustable)), the power calculation formula is $P = I^2 * R_{ds} (on)$. In the off area (where the current level is lower than the current reference (adjustable)), the power calculation formula is $P = 0$ watt.
- **Vce (sat)** -- In the on area (where the voltage level is lower than the voltage reference (adjustable)), the power calculation formula is $P = V_{ce} (sat) * I$. In the off area (where the current level is lower than the current reference (adjustable)), the power calculation formula is $P = 0$ watt.

Connection Guide

Touch **Signal** > **Connection Guide** to recall the connection guide of switching loss, as shown in the figure below. Please follow the instructions in this figure for connection. Touch the icon on the top right of the guide to close.

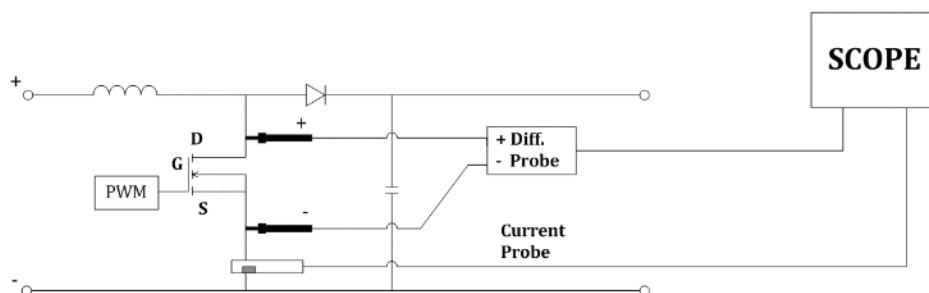

29.6 Slew Rate

The slew rate measures the change rate of voltage or current during switching.

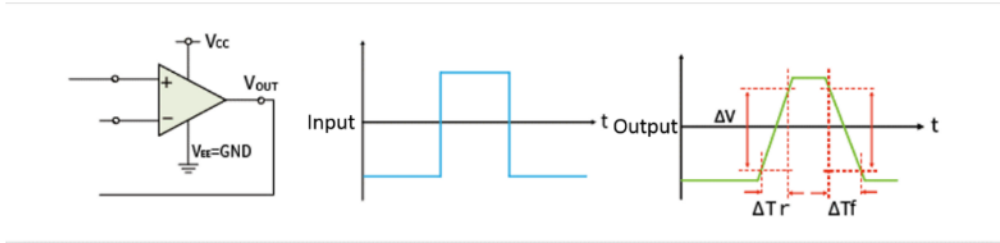

Connection Guide

Touch **Signal** > **Connection Guide** to recall the connection guide of slew rate, as shown in the figure below. Please follow the instructions in this figure for connection. Touch the icon on the top right of the guide to close.

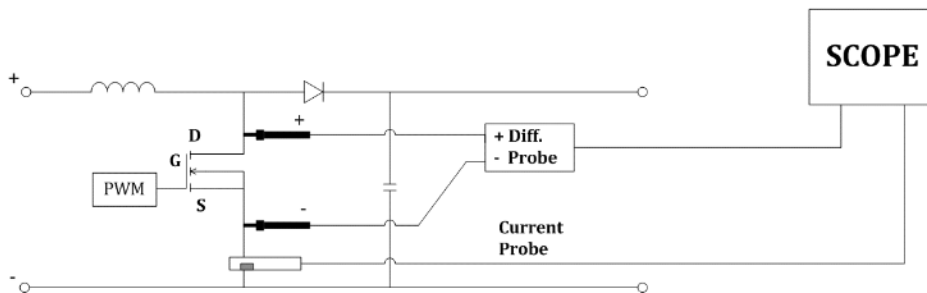

29.7 Modulation

Modulation analysis measures the control pulse signal of the switching device (MOSFET) and observes the pulse width, duty, period, frequency, and other trends of the control pulse signal in response to different events.

Connection Guide

Touch **Signal** > **Connection Guide** to recall the connection guide of modulation, as shown in the figure below. Please follow the instructions in this figure for connection. Touch the icon on the top right of the guide to close.

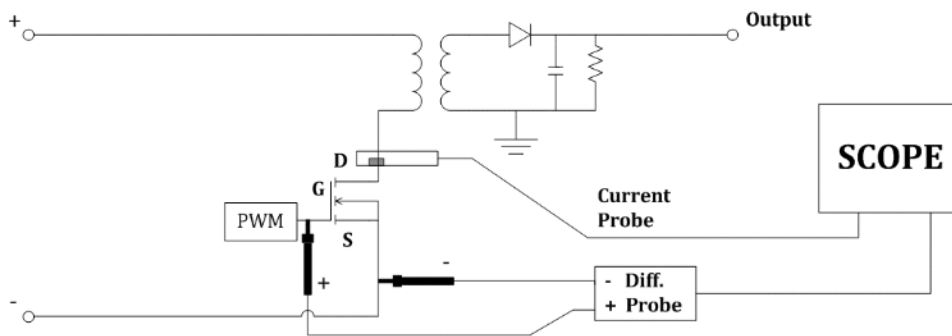

29.8 Output Ripple

Power supply ripple is an important parameter to evaluate DC power supply, which represents the quality of output DC voltage. Ripple analysis can measure the current value, average value, minimum value, maximum value, standard deviation, and count of the power supply output ripple.

Connection Guide

Touch **Signal** > **Connection Guide** to recall the connection guide of output ripple, as shown in the figure below. Please follow the instructions in this figure for connection. Touch the icon on the top right of the guide to close.

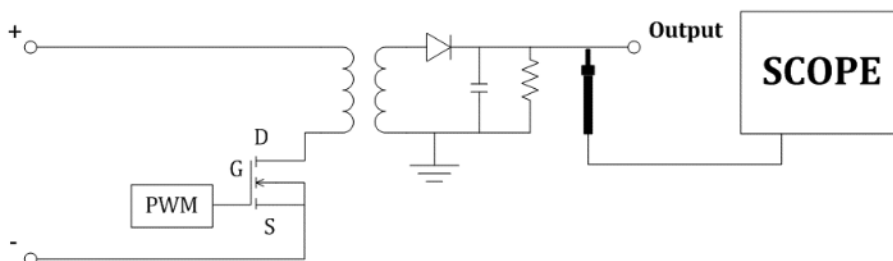

29.9 Turn On/Turn Off

Turn-on analysis determines the time taken for the power supply to reach 90% of its steady-state output. Turn-off analysis determines the time taken for the power supply to fall to 10% of its maximum output voltage.

Signal Settings

Touch **Signal** to recall signal settings dialog box:

- A. Set the input voltage source
- B. Set the output voltage source
- C. Set the input type (AC or DC)
- D. Set the duration, the range is 5 ns ~ 20 s. The oscilloscope will set the timebase according to the value (duration / 10)
- E. Set the maximum effective input voltage V_{rms} , the range is 1 V ~ 1 kV. The oscilloscope will set the vertical scale of the voltage channel to maximum input voltage / 7 and the trigger level to maximum input voltage / 10.
- F. Set the stable output voltage value, the range is -30 V ~ 30 V. The oscilloscope will set the vertical scale of the output voltage channel to stable output voltage / 6
- G. View the connection guide
- H. Return to the previous menu

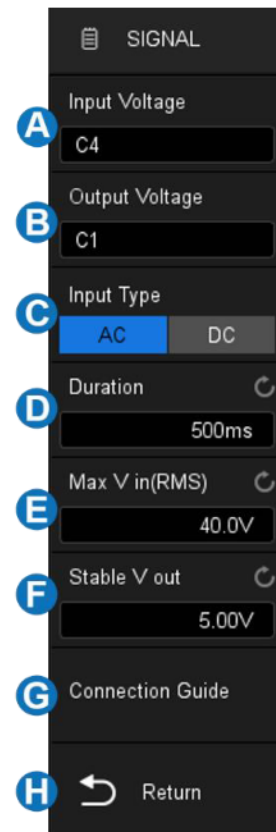

Testing Conditions

- **Turn On** -- Determines the time taken for the power to reach a certain percentage of its steady-state output. The turning on time is between T2 and T1, where:
 - T1 = When the input voltage first rises to a certain percentage (usually 10%) of its maximum amplitude
 - T2 = When the output DC voltage rises to a certain percentage (usually 90%) of its maximum amplitude
- **Turn Off** -- Determines the time it has taken for the power supply to be turned off to fall to a certain percentage of its maximum output voltage. The turning off time is between T2 and T1, where:

T1 = When the input voltage finally falls to a certain percentage (usually 10%) of its maximum amplitude

T2 = When the output DC voltage finally falls to a certain percentage (usually 10%) of its maximum amplitude

Connection Guide

Touch **Signal** > **Connection Guide** to recall the connection guide of turn on/turn off, as shown in the figure below. Please follow the instructions in this figure for connection. Touch the icon on the top right of the guide to close.

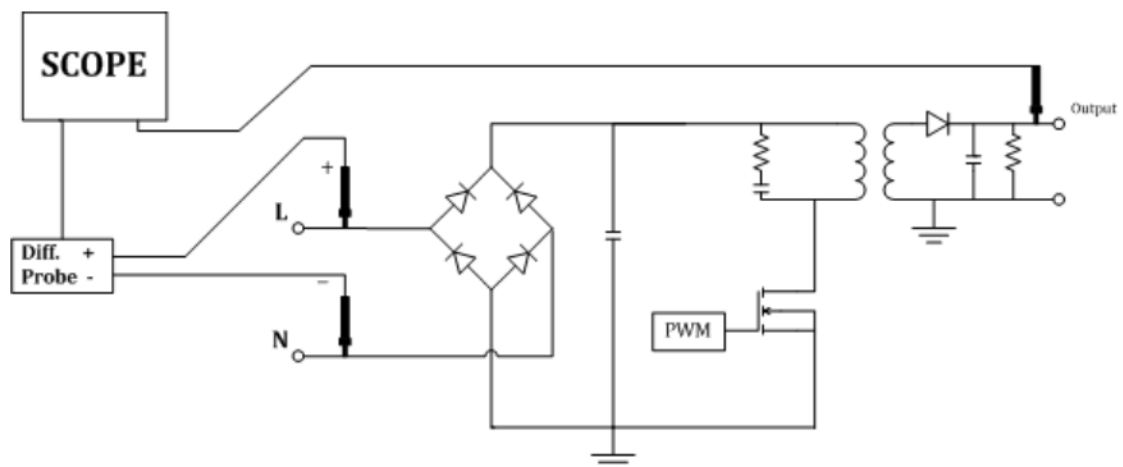

29.10 Transient Response

Transient response analysis can determine the response speed of the output voltage of the power supply to the change of the output load. This time starts from the first time that the output voltage exits the stable band and ends at the last time that the output voltage enters the stable band.

Signal Settings

Touch **Signal** to recall signal settings dialog box:

- A. Set the output voltage source
- B. Set the output current source
- C. Set the duration. The oscilloscope will set the appropriate time base according to the duration
- D. Set the stable output voltage, i.e. the expected output DC voltage of the power supply in a stable state
- E. Set the overshoot percentage of output voltage, which can be used to determine the stable band value of transient response and adjust the vertical scale of the oscilloscope
- F. View the connection guide
- G. Return to the previous menu



Configuration

Touch **Config** to recall the configuration dialog box:

- A. Set the input low current value. This is the expected low current value before or after the load change
- B. Set the input high current value. This is the expected high current value before or after the load change
- C. Return to the previous menu

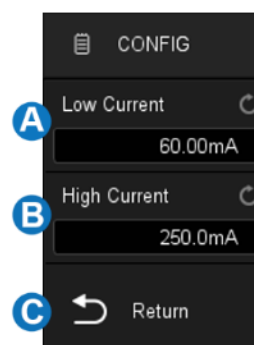

Note: The low and high current values are used to calculate the trigger level and adjust the oscilloscope vertical scale. After the load changes, the current value changes from low to high (or from high to low), and the oscilloscope triggers and performs to measure the transient response stability time.

Connection Guide

Touch **Signal** > **Connection Guide** to recall the connection guide of transient response, as shown in the figure below. Please follow the instructions in this figure for connection. Touch the icon on the top right of the guide to close.

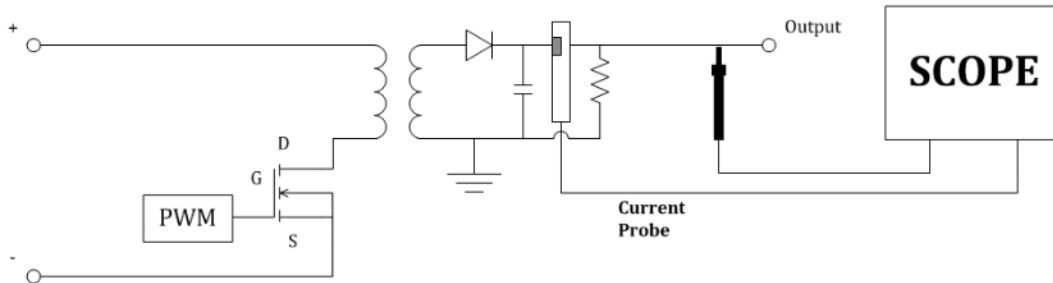

29.11 PSRR

The power supply rejection ratio (PSRR) test is used to determine how the regulator suppresses ripple noise in different frequency ranges. The oscilloscope controls the arbitrary waveform/function generator to output a sweep signal, which is used to introduce ripple into the DC voltage transmitted to the voltage regulator. Measure the AC RMS ratio of input to output, and plot the relationship between the ratio and frequency. The background noise of the oscilloscope is higher than that of the network analyzer, and the sensitivity is lower than that of the network analyzer, so the PSRR measured by the oscilloscope is difficult to exceed -60 dB. The PSRR test is generally acceptable for sampling the overall PSRR behavior of the power supply under test.

The configuration of PSRR is the same as that of the Bode plot, see the chapter "Bode Plot" for details.

Connection Guide

Touch **Signal** > **Connection Guide** to recall the connection guide of PSRR, as shown in the figure below. Please follow the instructions in this figure for connection. Touch the icon on the top right of the guide to close.

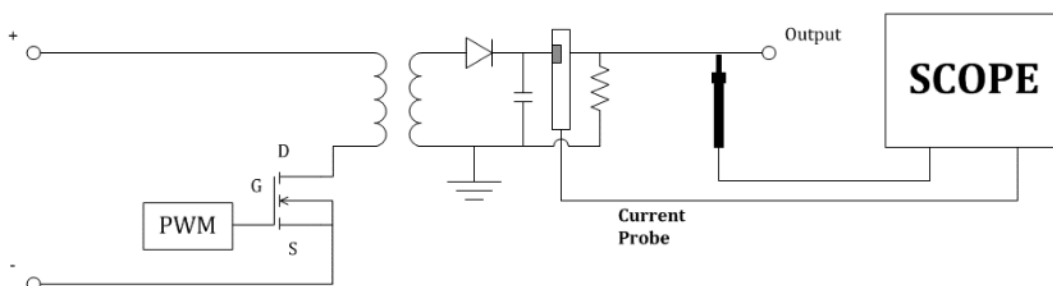

29.12 Power Efficiency

Power efficiency analysis can test the overall efficiency of the power supply by measuring the output power and input power. This analysis is only supported on 4-channel models because all of the input voltage, input current, output voltage, and output current are necessary for the measurement.

Connection Guide

Touch **Signal** > **Connection Guide** to recall the connection guide of power efficiency, as shown in the figure below. Please follow the instructions in this figure for connection. Touch the icon on the top right of the guide to close.

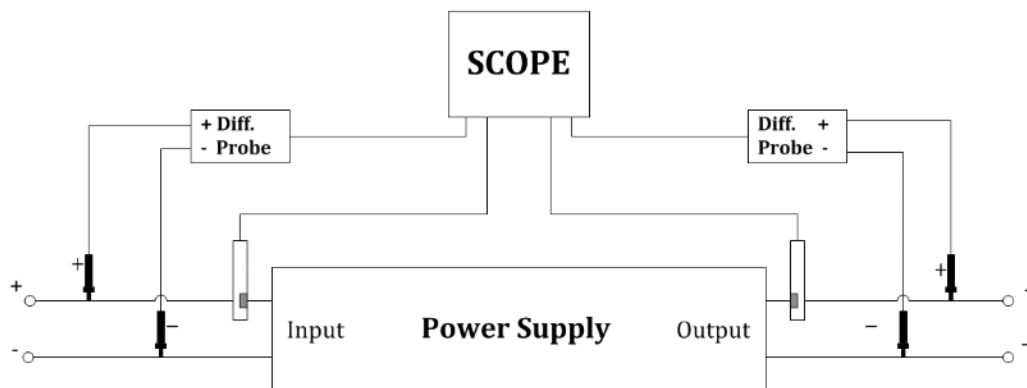

29.13 SOA

The safe operating area (SOA) of MOSFETs defines the voltage, current, and power consumption conditions over which the device can be expected to operate without self-damage. The oscilloscope can automatically generate the SOA according to the **Voltage Limit**, **Current Limit**, and **Power Limit** parameters set in the **Config** menu, and judge if the stress on the MOSFET is beyond the SOA or not. This helps the designers to quickly find a problem or latent risk in the circuit.

Connection Guide

Touch **Signal** > **Connection Guide** to recall the connection guide of power efficiency, as shown in the figure below. Please follow the instructions in this figure for connection. Touch the icon on the top right of the guide to close.

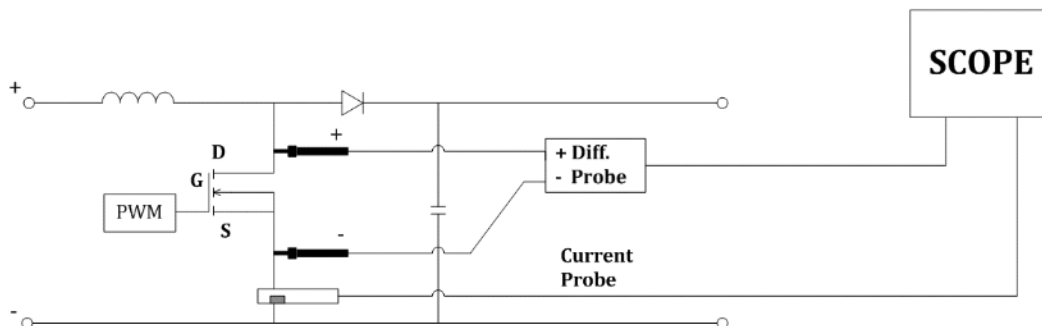

Note: Perform a Deskew operation between the voltage and current input channels before the test. See section “Switching Loss” for more details on deskewing.

The test steps are as followed:

1. In the **Input Setup** menu, assign correct channels to **Input Voltage** and **Input Current**. Set **Duration** as the expected observed duration, then the oscilloscope will automatically set the timebase according to it.
2. In the **Config** menu set **Voltage Limit**, **Current Limit**, and **Power Limit** parameters according to the datasheet of the MOSFET device under test, then the oscilloscope will automatically generate the SOA and the vertical scale of the **Input Voltage** and **Input Current** channels according to them.
3. Turn on **Test State**. The oscilloscope will begin to acquire the voltage and current waveforms, and display the SOA measurement, showing if the measured stresses are in the SOA or not.
4. Users can adjust horizontal, vertical, and trigger settings during the test for best observation.

Below is an example of testing the power-up stresses on a MOSFET and judging if the stresses are safe for the MOSFET using the SOA:



Voltage and current waveforms on the MOSFET at power-up

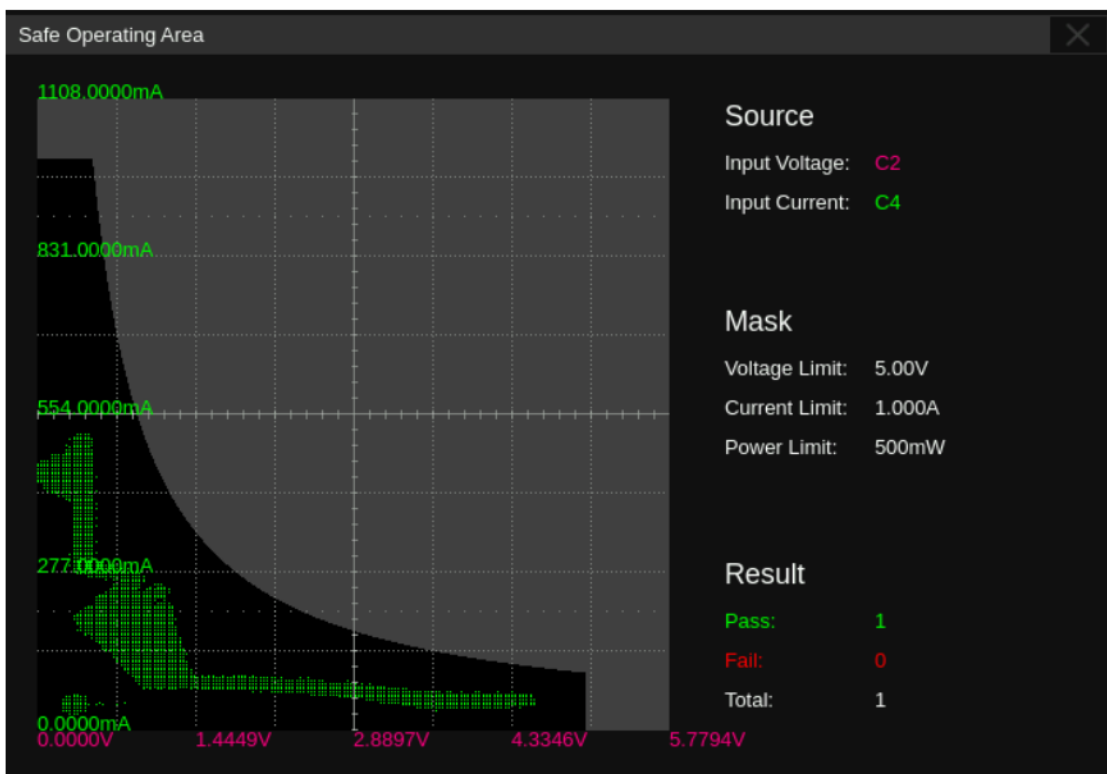

SOA, in which the mask is created according to the voltage limit, current limit, and power limit. The result shows “Pass” because all the stresses are within the mask.

30 Bode Plot

30.1 Overview

The SDS3000X HD supports an automatic Bode plot function. This function provides a frequency response curve of the device-under-test as well as the interface for output sweep parameter control and data display settings. At this time, either the SIGLENT SAG1021I arbitrary waveform generator or one of a SIGLENT SDG series arbitrary function generators are supported. During the sweep, the oscilloscope configures the generator output frequency and amplitude and then compares the input signal to the output of the DUT. Gain (G) and phase (P) are measured at each frequency and plotted on the frequency response Bode plot. When the loop response analysis is complete, you can move the markers on the chart to see the gain and phase values measured at each frequency point. You can also adjust the scale and offset settings for the amplitude and phase plots.



Touch **Analysis** > **Bode Plot** to recall Bode plot dialog box:

- A. Turn on/off the Bode plot
- B. Configure the Bode plot (DUT, AWG connection, sweep parameters)
- C. Turn on/off the operation
- D. Set display parameters, including coordinate axis, trace visibility, and cursors
- E. Data list. Open the data list of the Bode plot to view the curve data, save the data results to a U-disk or recall it from a U-disk
- F. Set the measurement parameters. Parameter measurement of scanning curve includes upper cut-off frequency (UF), lower cut-off frequency (LF), bandwidth (BW), gain margin (GM), and phase margin (PM)
- G. Quickly print the specified Bode Plot waveform area to the storage

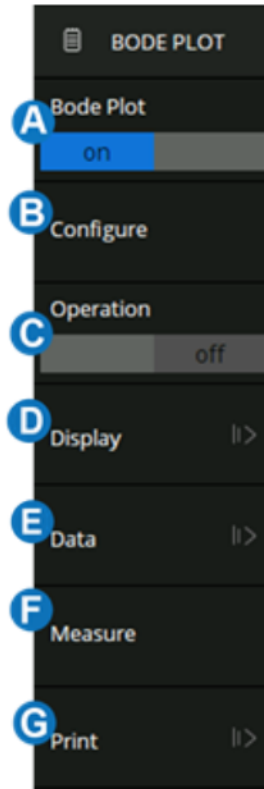

30.2 Configuration

30.2.1 Connection

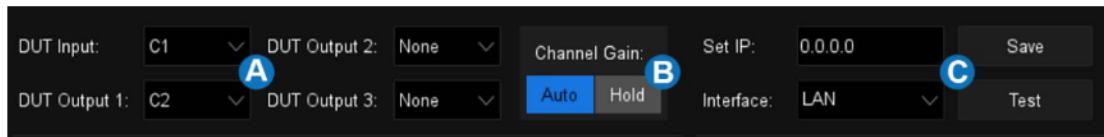

- A. DUT input and output channels
- B. Channel gain. When it is set to Auto, the oscilloscope will automatically adapt the vertical scale according to the signal amplitude; when it is set to Hold, it will always keep the vertical scale before the test operation
- C. Arbitrary waveform generator connection settings. Touch **Interface** to select the connection type. When selecting LAN, it needs to **Set IP** and **Save** it. Touch **Test** to confirm whether the arbitrary waveform generator is connected correctly.

30.2.2 Sweep

Touch **Sweep Type** to select the sweep type. There are two types: Simple and variable level.

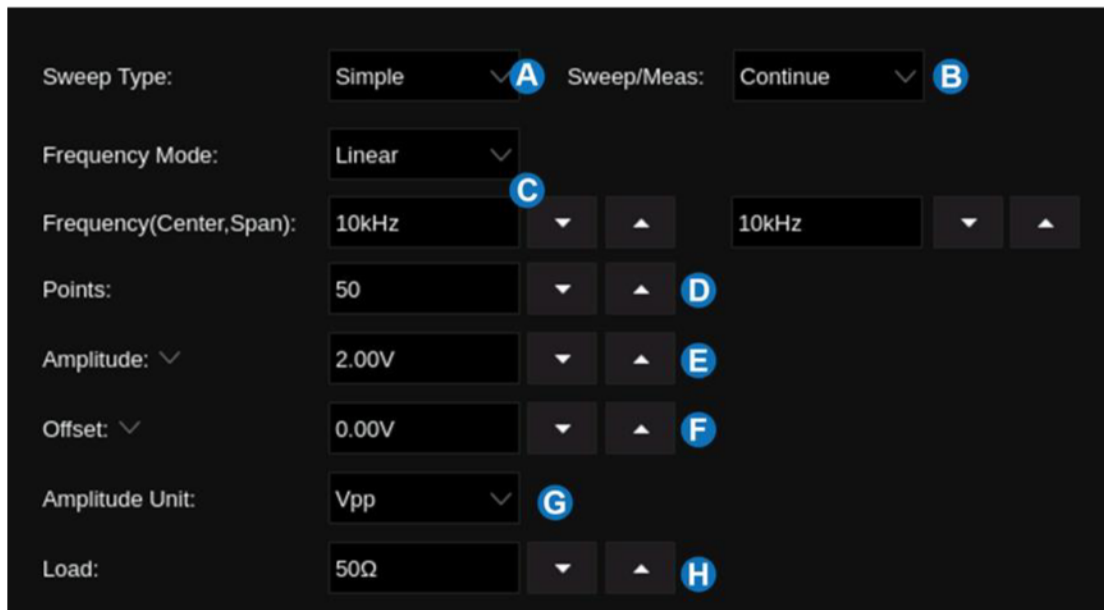

- A. Set the sweep type
- B. Set the sweep as Continue or Single
- C. Set the sweep frequency. The frequency mode can be linear or decade. When it is set to linear, the corresponding center frequency and span frequency need to be set; when it is set to a decade, the corresponding start frequency and stop frequency need to be set

- D. Set the number of sweep points. The larger the number of points, the higher the sweep resolution
- E. Set the amplitude of the sweep signal
- F. Set the offset of the sweep signal
- G. Set the signal amplitude unit. When it is set to dB, reference level and load need to be set
- H. Set the load

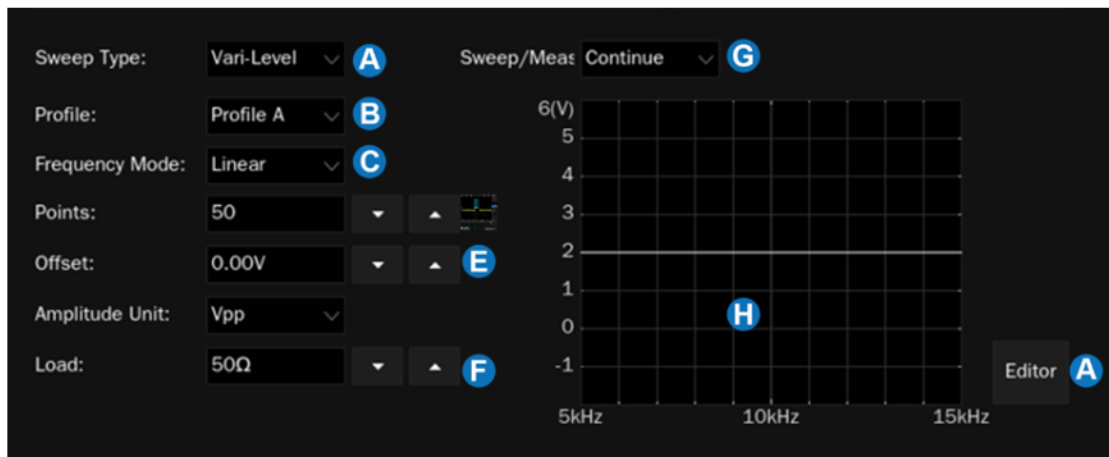

- A. Set the sweep type to Vari-Level
- B. Select a profile. Up to 4 profiles can be edited
- C. Set the frequency mode
- D. Set the number of sweep points
- E. Set the offset of the sweep signal
- F. Set the signal amplitude unit. When it is set to dB, reference level and load need to be set
- G. Set the sweep as Continue or Single
- H. Variable level signal display area
- I. Touch **Edit** to turn on the profile editor

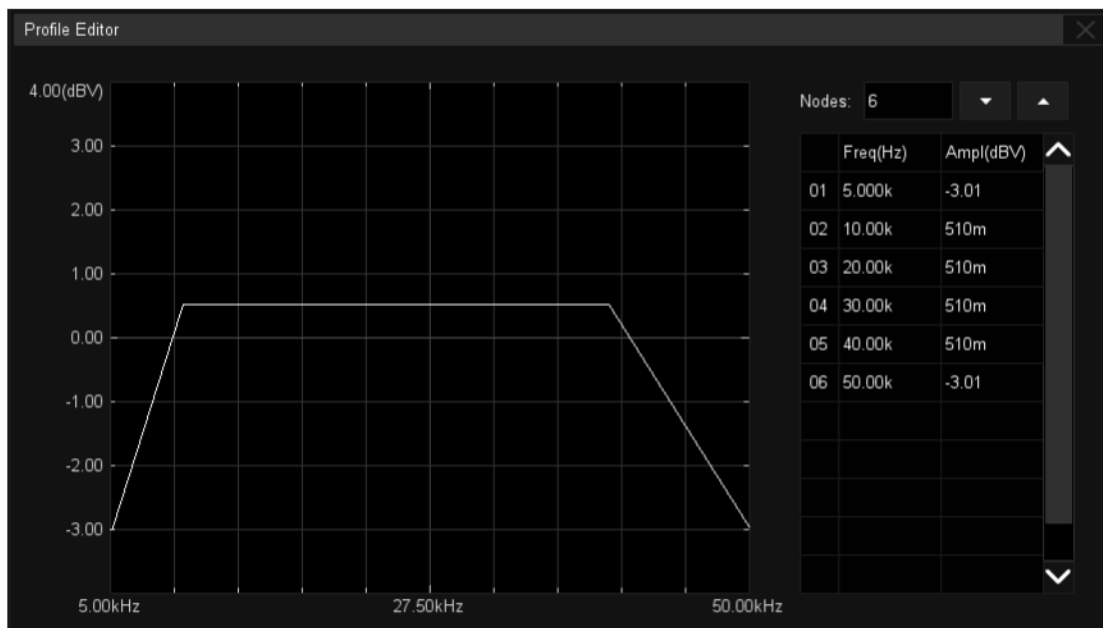

Touch **Nodes** to set the signal node number through the universal knob, or touch ▲ to increase the nodes and ▼ to decrease.

Touch the cell in the table area to set the frequency and amplitude of the corresponding node. Touch to activate the cell, adjust the value through the universal knob, or touch the cell again to call up the virtual keypad for setting.

30.3 Display

Bode plot display settings include amplitude, phase, cursors, trace visibility and waveform type.

Amplitude

Set the amplitude coordinate axis of the Bode plot. Touch **Display** > **Amplitude** to recall the amplitude setting dialog box:

- Set the reference position to center or top
- Set the scale of the amplitude coordinate axis
- Set the reference level, the max value of the amplitude coordinate axis
- Set the amplitude mode. Set to Vout to display the amplitude value of the output signal; set to Vout/Vin to display the amplitude ratio of the output signal to the input signal
- When the mode is Vout, it needs to set the unit (Vpp, Vrms, dBV, dBu, dBm, or Arbitrary dB); when the mode is Vout/Vin, it needs to set the amplitude axis type (Linear or Logarithmic).
- Auto-Set. According to the output signal amplitude curve, the oscilloscope automatically sets the scale and reference level
- Return to the previous menu

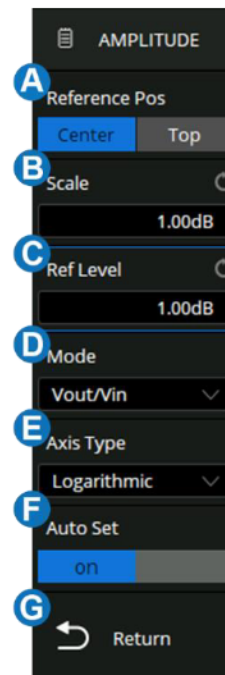

Phase

Set the phase coordinate axis of the Bode plot. Touch **Display** > **Phase** to recall the phase setting dialog box:

- Set the reference position to center or top
- Set the scale of the phase coordinate axis
- Set the reference level, the max value of the phase coordinate axis
- Set the phase unit (Degree or Rad)
- Auto-Set. According to the output signal phase curve, the oscilloscope automatically sets the scale and reference level
- Return to the previous menu

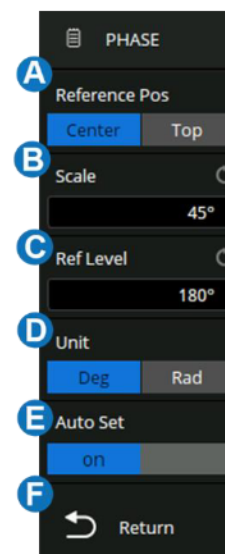

Cursors

SDS3000X HD can use the cursor to measure the Bode plot curve. The cursor of the Bode plot is similar to the ordinary cursor, see the chapter "Cursors" for details. Touch **Display** > **Cursors** to recall the cursor setting dialog box.

- A. Turn on/off the cursors of the Bode plot
- B. Set the cursors type (X or Y)
- C. Specify the cursor and set the position (by gestures, universal knob, or virtual keypad)
- D. Set the source 1
- E. Set the source 2
- F. Return to the previous menu

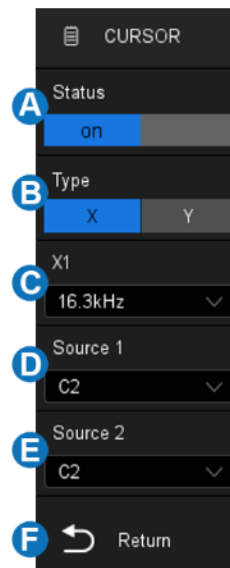

Trace Visibility

When multiple output signals are connected, the Bode plot interface will display the amplitude and phase curves of all output signals at the same time. Users can turn on/off other scanning curves to observe the details of specific curves. Touch **Display** > **Trace Visibility** to recall the setting dialog box.

30.4 Data Analysis

With the data list, cursor measurement, and automatic measurement functions, the Bode plot curve can be analyzed in detail. The data list provides the information of each scanning point. The cursors can be used to flexibly measure the change of each position of the curve. The automatic measurement function can be used to measure the five parameters of the Bode plot curve: upper cut-off frequency (UF), lower cut-off frequency (LF), bandwidth (BW), gain margin (GM), phase margin (PM).



- A. Data list display area
- B. Cursors
- C. Data point location line
- D. Cursor information display area
- E. Measurement parameters display area
- F. Bode plot dialog box

Data List

Touch **Data** to recall the data setting dialog box:

- Turn on/off the data list
- Set the selected row in the list. Adjust the universal knob to set, or directly touch the list display area to select a specific line.
- Set the data source
- Save/Recall the data. Saving and recalling the Bode plot data (*.csv) is similar to the operation of setup files, see the chapter "Save/Recall" for details
- Return to the previous menu

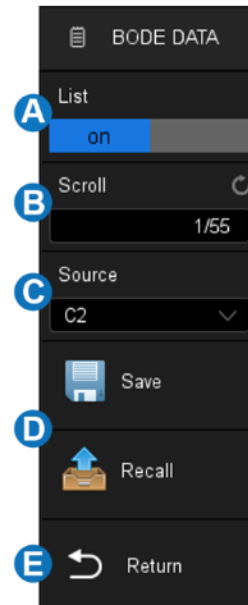

Measure

Touch **Measure** to recall the measure setting dialog box:

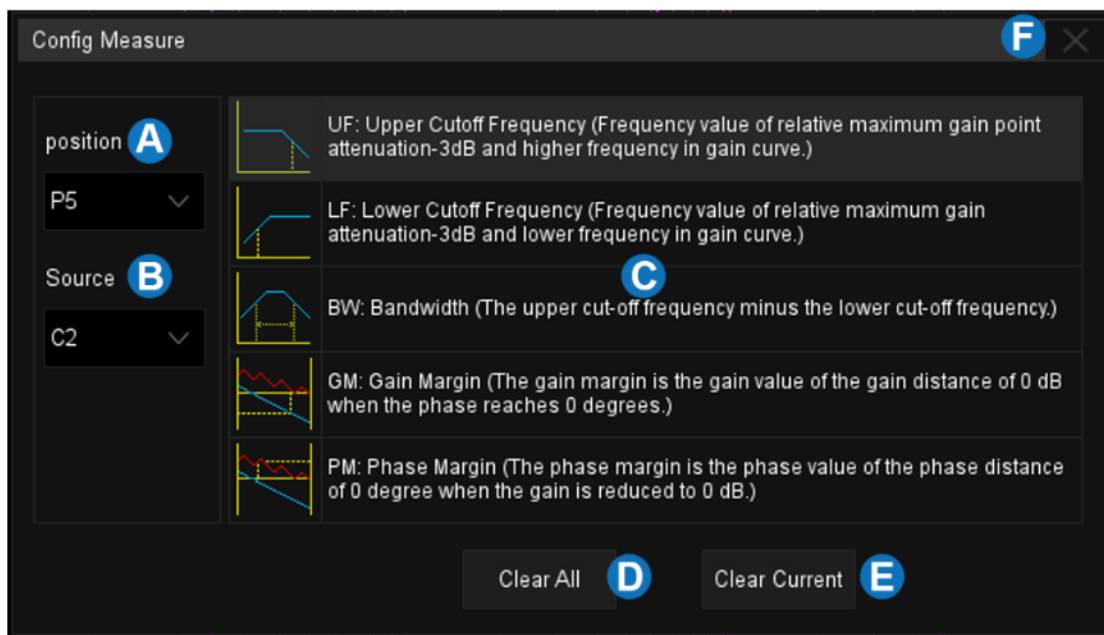

- Set the position of measurement items, and support 5 measurement items at most
- Set the measurement source
- Measurement parameter area. Touch each parameter area to activate the measurement parameter. In the figure above, "UF" is activated.
- Clear all measurements

- E. Clear the current measurement
- F. Close the measurement configuration window

For example, to add UF measurements for C2 and GM measurements for C3, follow the steps below:

Measure > *Position* > *Source* > *UF*
Measure > *Position* > *Source* > *GM*

31 Display

Display settings include display type of waveform, color, persistence, grid type, trace brightness, graticule brightness, etc.

Touch the menu **Display** > **Menu** to recall the display dialog box.

- A. Switch the waveform display type to Vectors (line display) or Dots
- B. Enable/disable color grading
- C. Set persistence
- D. Clear display. The operation clears all waveforms displaying on the screen and clears persist
- E. Set menu auto-hide time
- F. Set the menu style to Embedded or Floating. When set to Embedded, the grid area will be compressed horizontally to display the complete waveform when the dialog box is displayed. When set to Floating, it will directly cover part of the grid area when the dialog box is displayed
- G. Select the grid type (Full Grid, Light Grid, and No Grid)
- H. Set the trace intensity (0~100%)
- I. Set the backlight (0~100%)
- J. Set the graticule brightness (0~100%)
- K. Set the LED brightness (10~100%)
- L. Customize the colors of waveforms
- M. Display the axis labels

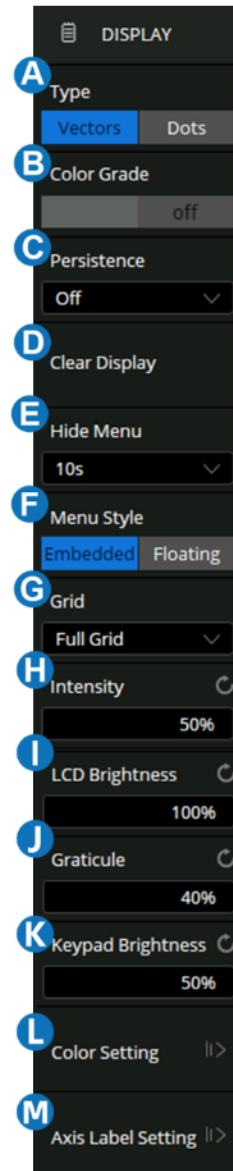

Display Type

There is no difference between the vector and dot display types when the number of samples of a frame is greater than 1000. When the sample number is below 1000, there are some differences.

- **Vectors:** The samples are connected by lines (i.e. interpolated) and displayed. The interpolation methods include linear interpolation and $\sin(x)/x$ interpolation. See the section of "Acquisition Setup" for details of interpolation.

- **Dots:** Displays the raw samples directly.

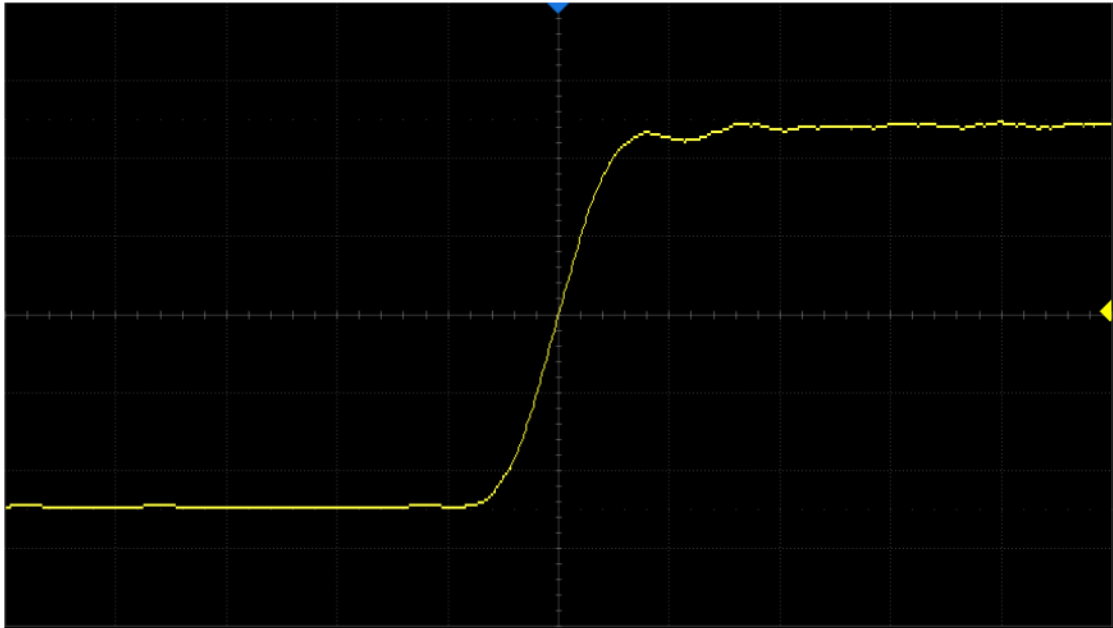

Vector Display

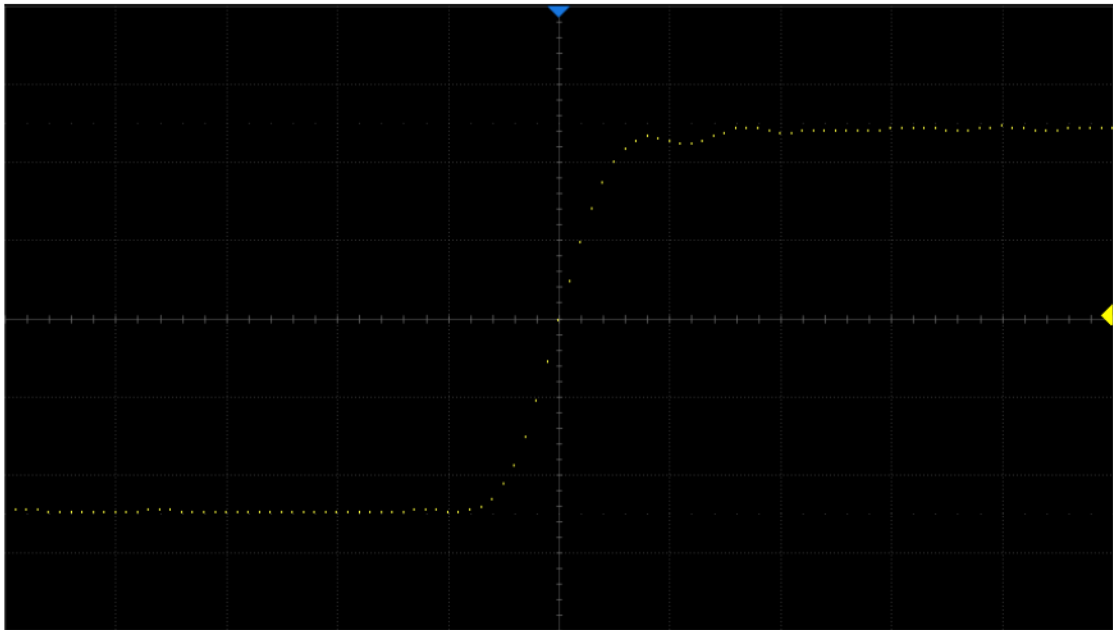

Dot Display

Note: In the Run state, due to the high waveform update rate of the oscilloscope, the waveform displayed is the superposition of multiple frames. Therefore, what is seen using the dots display is not the discrete sampling points, but the display effect similar to equivalent sampling. Stop the acquisition to view the original samples of each frame separately.

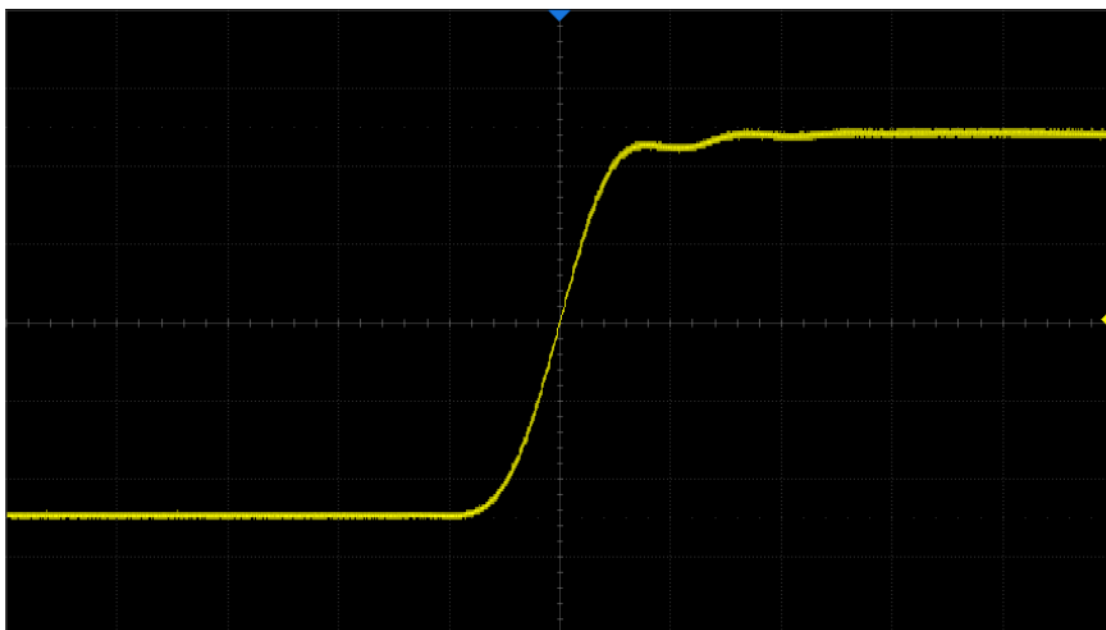

Dots display in Run state

Color Grade

Color grade uses color temperature to map the probability of the waveforms. The greater the probability that the waveform appears in a pixel, the warmer the color of the pixel. The smaller probability, the colder the color temperature of that pixel.

The picture below shows the change of color from cold to warm.

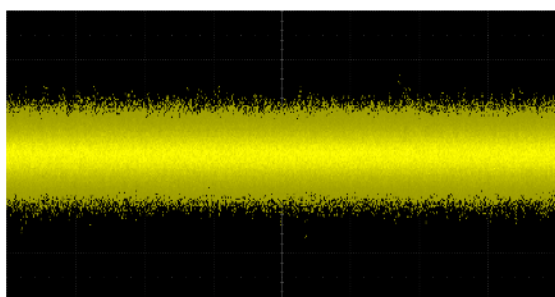
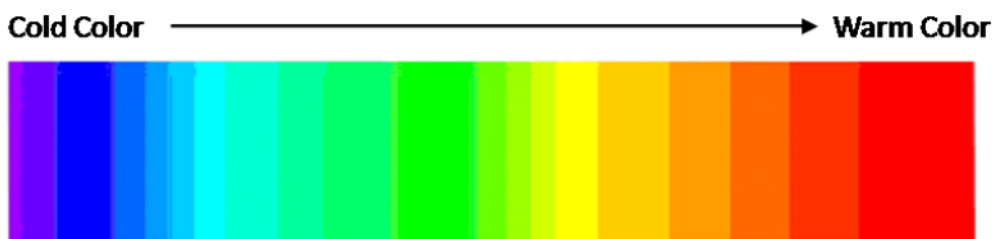

Color grade On

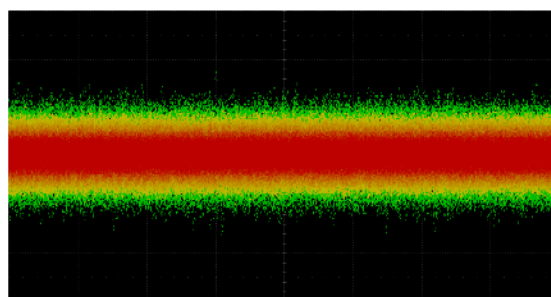

Color grade Off

Set Persist

With persistence, the oscilloscope updates the display with new acquisitions but does not erase the results of previous acquisitions in the specified period. All previous acquisitions are displayed with reduced intensity. New acquisitions are shown in their normal color with normal intensity. In combination with SDS3000X HD's high waveform update rate and persist function, in some cases anomalies in the waveform can be found in a short time without complex trigger settings to improve test efficiency. Below is an example to display glitches in a data sequence with infinite persistence.

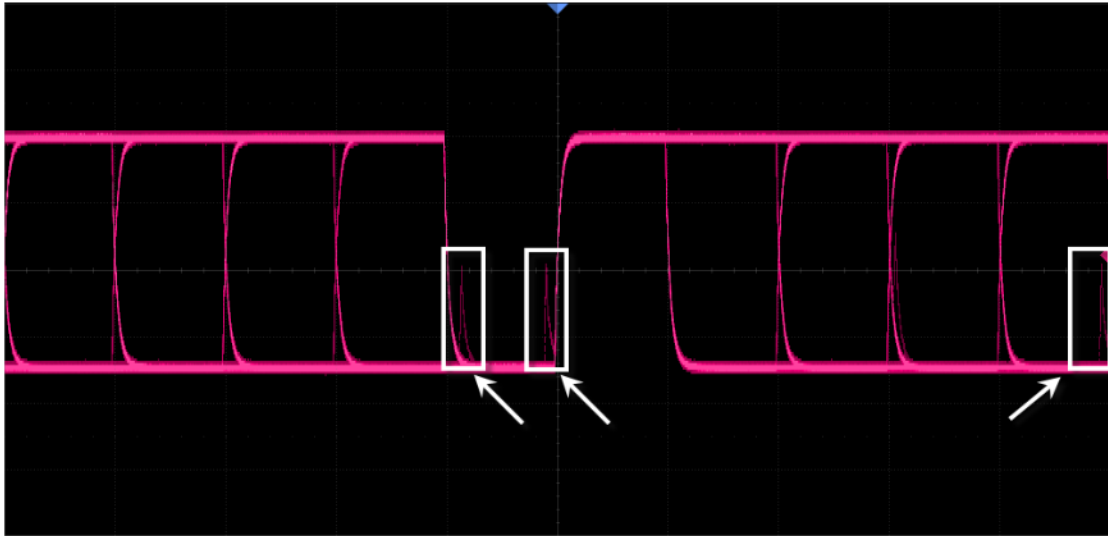

When the display dialog box and persist are off, touch **Display** > **Persistence** can quickly turn on persist.

Touch **Persist** in the display dialog box to set the persistence time.

- **Off:** Turn off persist.
- **Variable persist time (100ms, 200ms, 500ms, 1s, 5s, 10s, 30s):** Choose different persist times. The oscilloscope updates with the newly acquired waveform display. Acquired waveforms will be cleared after the corresponding time has expired.
- **Infinite:** Select "Infinite", previous acquisitions will never be erased until a **Clear Display** or **Clear Sweeps** operation is performed.

Set Grid

- **Full Grid:** Display 8*10 grid
- **Light Grid:** Display 2*2 grid
- **No Grid:** Display without grid

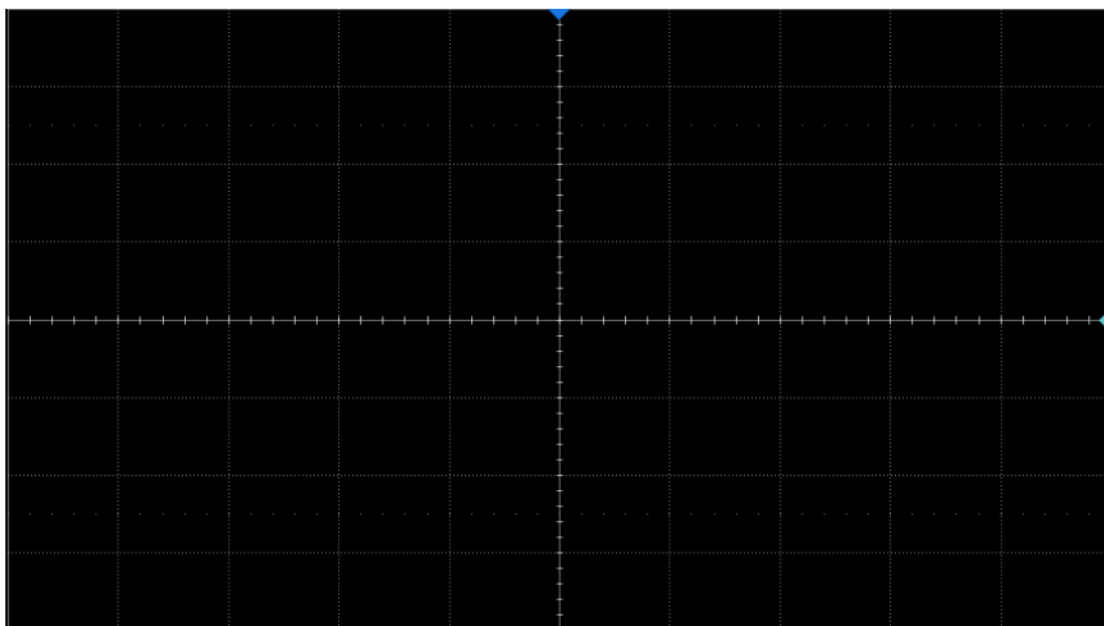

Full Grid

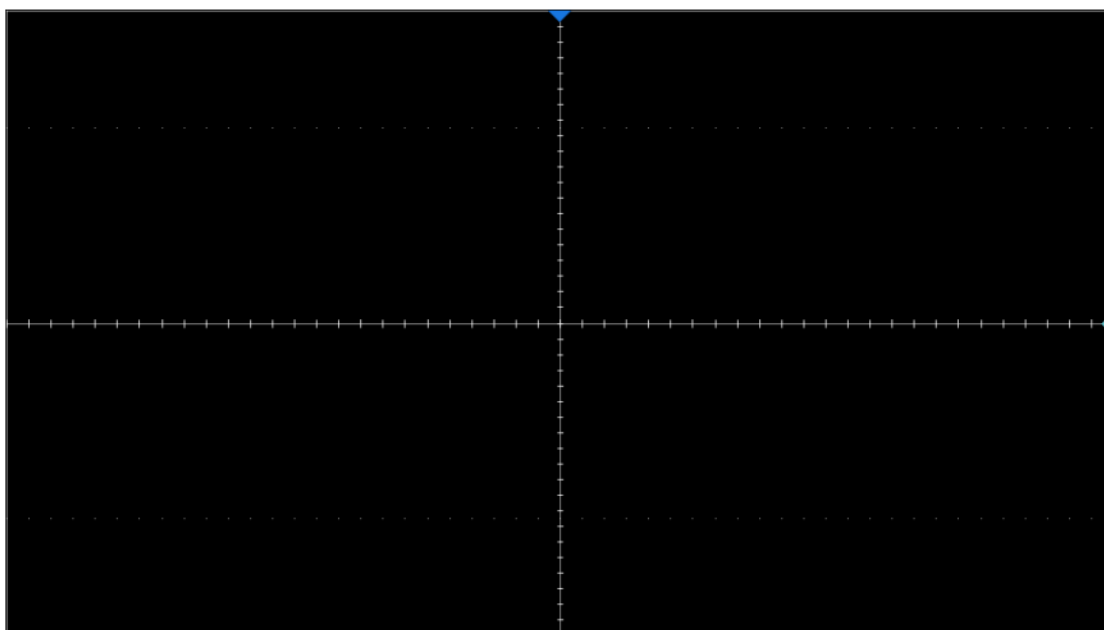

Light Grid

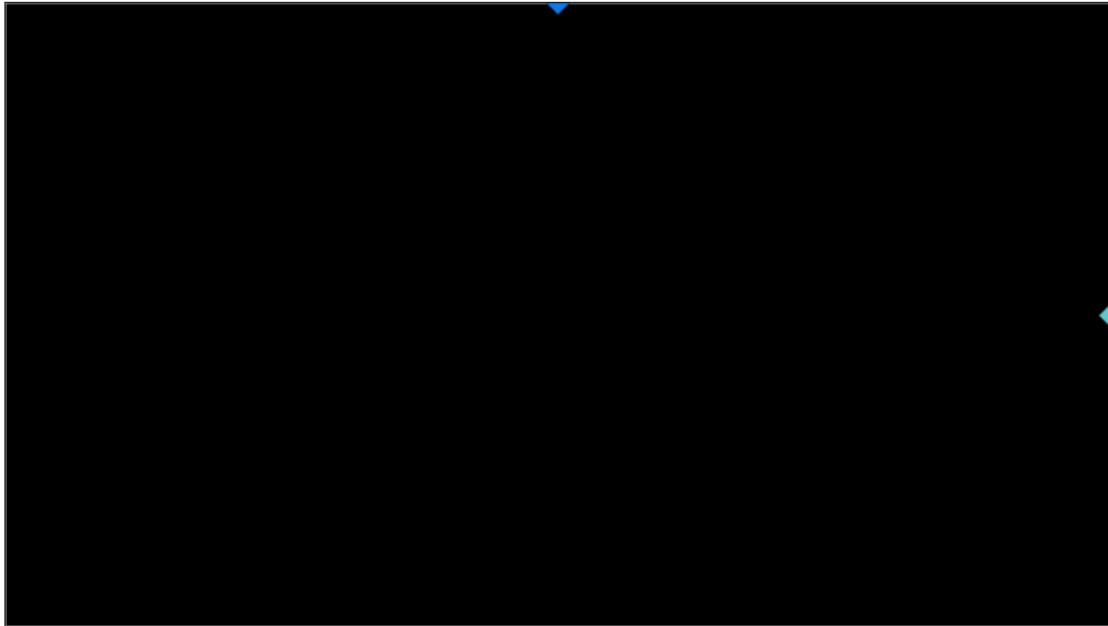

No Grid

Color Setting

The color setting supports user-defined trace colors. Touch the color rectangle box to set in the pop-up palette page. Touch the **Default** area to restore the default color for all channels.



Select a color directly on the palette and preview its hue, saturation, light, and RGB values or directly modify the color parameters to customize the color. After the change, touch **OK** to confirm.

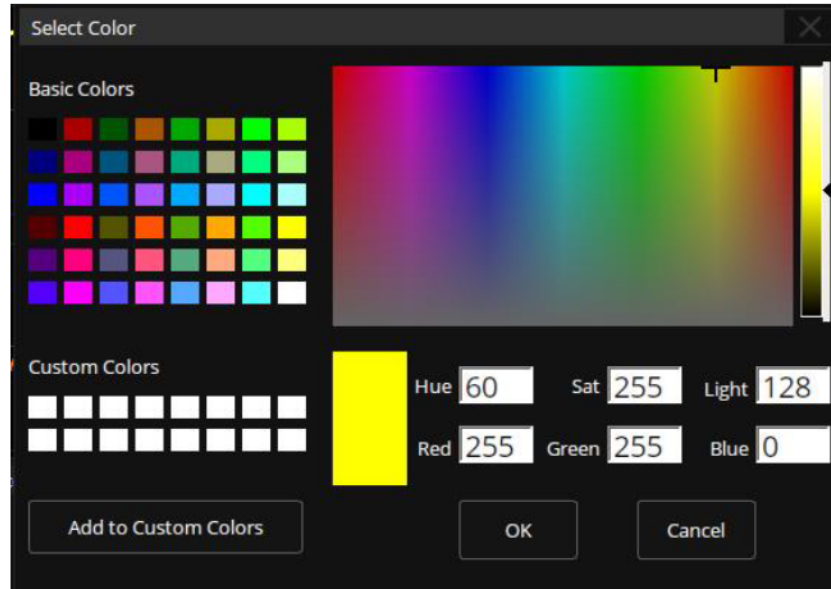

Axis Label Setting

Turn on the axis label, the horizontal axis label will be displayed at the bottom of the grid, and the vertical axis label will be displayed at the left of the grid. There are two display modes of axis: moving and fixed.

- **Moving mode:** When moving the waveform, the position of the axes moves with the waveform, while the coordinates remain fixed.
- **Fixed mode:** The position of the axes remain fixed, while the coordinates update as the waveform is moving.



Moving mode

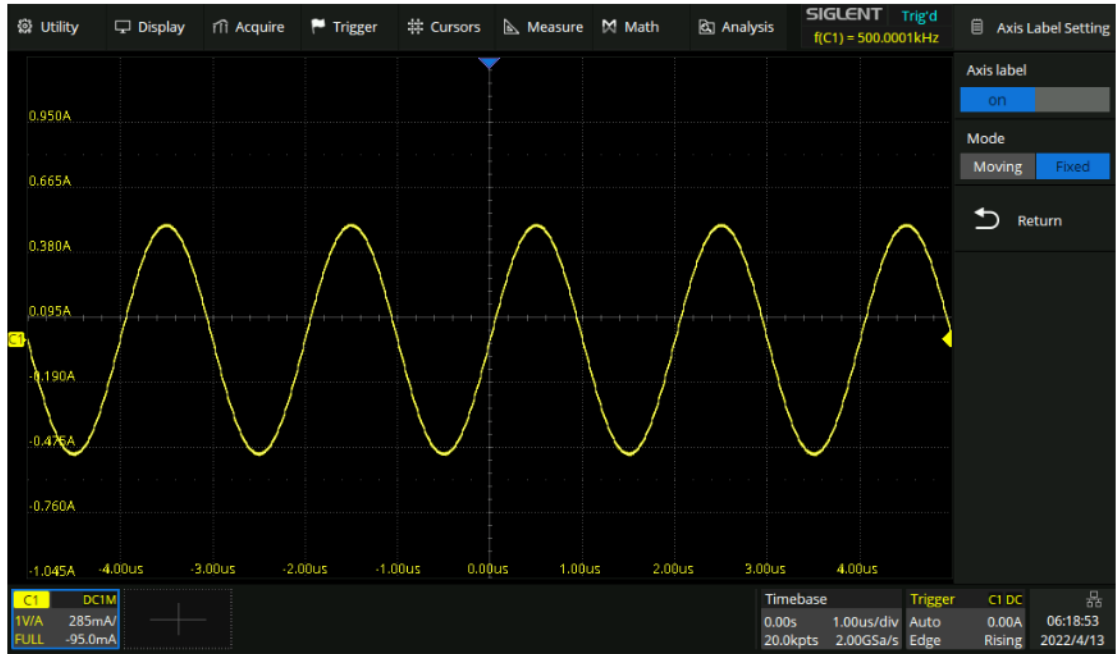

Fixed mode

32 Arbitrary Waveform Generator

32.1 Overview

The SDS3000X HD supports an external arbitrary waveform/function generation when purchasing SAG1021I and activated using option SDS3000HD-FG.

The AWG functions include:

- 6 basic waveforms: Sine, Square, Ramp, Pulse, Noise, and DC
- 45 built-in arbitrary waveforms
- Output frequency up to 50 MHz
- -3 V ~ +3 V output amplitude range
- 42 V isolated voltage

Refer to the datasheet for the detailed specifications of the AWG.

Press the **WaveGen** button on the front panel, or touch the menu **Utility** > **Wave Gen** to recall the dialog box.

- Turn on/off the output of AWG
- Select the waveform type (Sine, Square, Ramp, Pulse, Noise, DC, and Arb)
- Set the frequency
- Set the amplitude
- Set the offset
- Other AWG settings: Output load, overvoltage protection, and so on.
- System information and firmware upgrade



32.2 Output

For safety, pressing the **Wave Gen** button does not automatically turn on the output of AWG. To turn on the output, touch **Output** in the AWG dialog box after pressing **Wave Gen**. When the output is enabled, the **Wave Gen** button lights up.

32.3 Wave Type

The AWG function provides six standard waveforms and multiple arbitrary waveforms. The standard waveforms are Sine, Square, Ramp, Pulse, Noise, and DC.

The following table shows all waveform types and corresponding parameters.

| Wave Type | Parameters |
|-----------|--|
| Sine | Frequency, Amplitude, Offset |
| Square | Frequency, Amplitude, Offset, Duty |
| Ramp | Frequency, Amplitude, Offset, Symmetry |
| Pulse | Frequency, Amplitude, Offset, Duty |
| DC | Offset |
| Noise | Stdev, Mean |
| Arb | Frequency, Amplitude, Offset, Arb Type |

The Arbitrary waveforms consist of two types: built-in waveforms and stored waveforms. Touch **Arb Type** in the AWG dialog box, and select the arbitrary in the pop-up window:

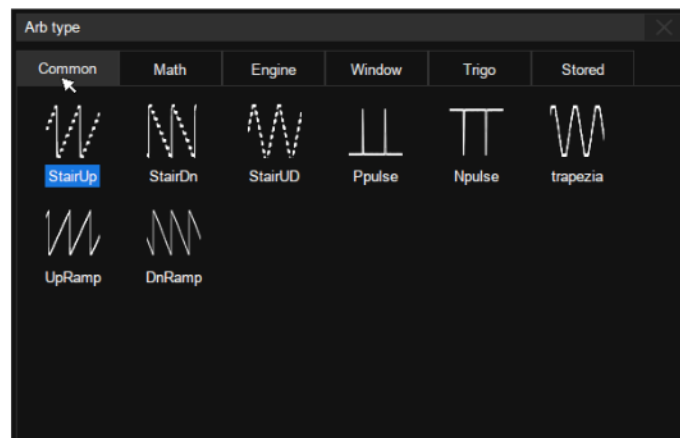

There are 6 tabs in the window. Under each tab, a catalog of waveforms is listed. Built-in waveforms are stored in Common, Math, Engine, Window, and Trigo. Stored waveforms are located in the Stored menu.

Users can edit arbitrary waveforms using SIGLENT EasyWaveX PC software, send the stored waveforms to the instrument through the remote interface, or import the stored waveforms through a U disk.

32.4 Other Setting

Touch **Setting** in the AWG dialog box to recall the "Other Setting" dialog box:

- A. Select the output load
- B. Turn on/off the OVP (Over Voltage Protection)
- C. Turn on/off the sync output. Only supported for external SAG1021I function/arbitrary waveform generator module.
- D. Do zero adjust
- E. Set to default
- F. Return to the previous menu

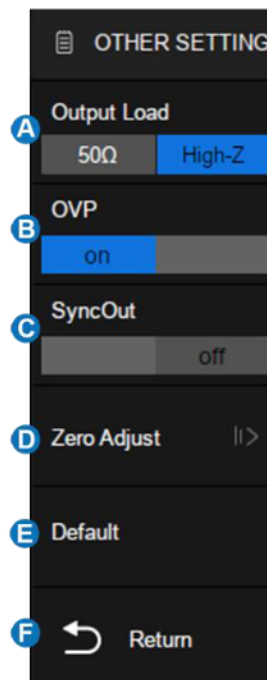

Output Load

The selected output load value must match the load impedance. Otherwise, the amplitude and offset of the output waveform of AWG will be incorrect.

OVP

When OVP is enabled, the output will be turned off automatically once the protection condition is met. The protection condition is when the absolute value on the output port is higher than $4\text{ V} \pm 0.5\text{ V}$. At the same time, a warning message is displayed.

Zero Adjust

The output zero error of the AWG can be calibrated by using auto mode or manual mode. The object of the Zero Adjust is: when AWG outputs 0 V DC signal, the measured mean value of the corresponding channel is within $\pm 1\text{ mV}$.

- **Auto Steps:** In this mode, the adjustment can only be performed with C1 of the oscilloscope. Connect the output of AWG to C1 of the oscilloscope, press **Auto** , and the AWG will start to automatically adjust. The scope will display “Zero adjust completed!” when the adjustment is done.
- **Manual Steps:** The AWG can be manually calibrated through any channel on the oscilloscope. Take C2 as an example:
 - 1) Connect the output of AWG to C2, open C2, set it to DC coupling, turn on the bandwidth limit, and set the probe attenuation to 1X.
 - 2) Set the vertical scale of C2 to a small scale such as 1 mV/div. Turn on Measure and set the parameter to the Mean of C2.
 - 3) Press **Manual** and rotate the universal knob to adjust the compensation value, until the mean value of C2 is within ± 1 mV, and then press **Save** .

32.5 System

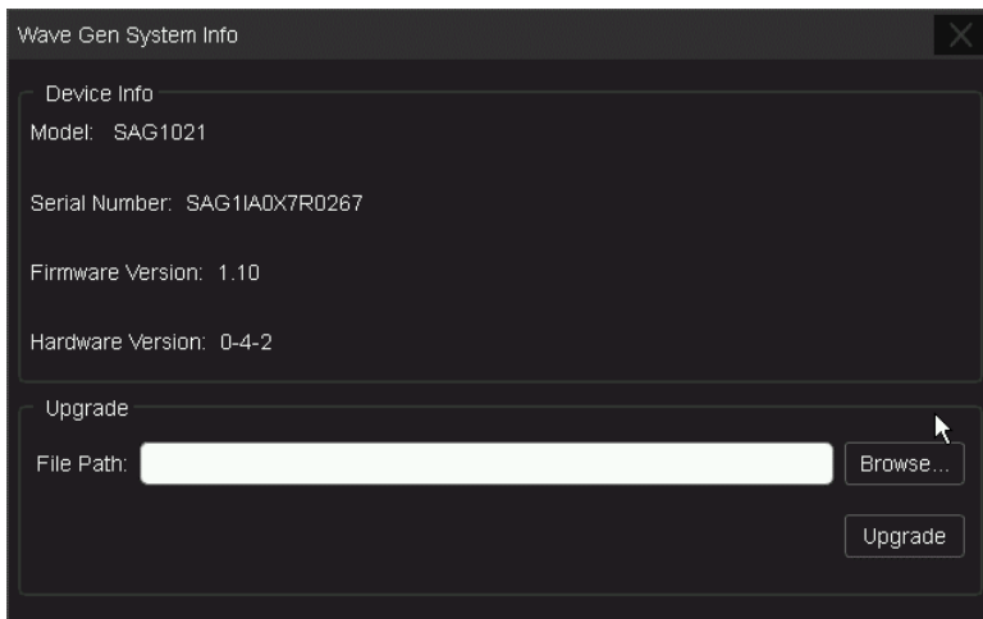

Device Info -- Includes Model, Serial Number, Firmware Version, and Hardware Version of the AWG module.

Upgrade

The firmware here refers to the firmware of the SAG1021I module. The SDS3000X HD supports firmware and configuration file upgrades for the SAG1021I via a U disk. Follow the steps below:

1. Copy the upgrade file (*.ADS) to the U disk.
2. Insert the U disk to one of the USB host ports of the oscilloscope.
3. Touch **Browse** to select the path of the upgrade file. See the chapter "Save/Recall" for the

detailed operation.

4. Touch **Upgrade** to start the upgrade progress. A progress bar shows the percentage finished.
5. After the upgrade, the SAG1021I will be removed from the system, and the oscilloscope prompts "Upgrade completed. Please reconnect the AWG device."
6. Enter the **System** dialog box again to check if the upgraded hardware version number is consistent with the target version.



Warning: Don't cut off the power during the upgrade!

33 Save/Recall

The SDS3000X HD supports saving setups, screenshots, and waveform data files to internal storage, external USB storage devices (e.g. U disk), or network storage. Saved setups and waveforms can be recalled as needed.

For details of network storage, refer to the section “SMB Files share”.

33.1 Save Type

SDS3000X HD supports save types: Setup, Image (*.bmp/*.jpg/*.png), Waveform Data (binary/CSV/MatLab), and FileConverter Tool. It also supports saving the current setup as the default setting. Here are brief descriptions of save types:

Setup

The default save type of the oscilloscope. The setup is saved with the *.xml file extension.

BMP

Saves the screenshot in *.bmp format.

JPG

Saves the screenshot in *.jpg format.

PNG

Saves the screenshot in *.png format.

Binary Data

Saves the waveform data in binary (*.bin) format.

CSV Data

Saves the waveform data in ".csv" format. After selecting this type, you can touch the **ParaSwitch** to determine whether to include the scope configuration parameter information (horizontal timebase, vertical scale, etc.) or not. Touch the **Save All Channel** to save all displayed waveforms on the screen or select the **Source** to save. The available sources include C1 ~ C4, F1 ~ F4 and M1 ~ M4.

Matlab Data

Saves the waveform data in *.mat or *.dat format which can be imported by Matlab directly. The

available sources include C1 ~ C4, F1 ~ F4 and M1 ~ M4 (except for FFT).

To Default Key

The oscilloscope provides two options for the default setting. When the Default Type is set to “Factory”, the factory default setting will be recalled by pressing the Default button on the front panel; When the Default Type is set to “Current”, the last setting saved by the “To Default Key” operation will be recalled by pressing the Default button on the front panel.

FileConverter Tool

The mini tool is used to convert stored binary files to CSV format for viewing with a spreadsheet program. This is ideal when collecting large datasets. For a waveform frame with deep memory (Greater than 10 Mpts), saving directly as a CSV file will take a long time and will occupy a large amount of memory on a USB storage device. It's recommended to save the data as a binary file and then convert it to a CSV file on a computer.

To Memory

Saves the waveform data to memory(M1~M4) , refer to chapter “Memory” for detailed information.

The following table shows the relationship between the save types and save/recall operations.

| Type | Save to External | Recall |
|---------------|------------------|--------|
| Setup | √ | √ |
| BMP | √ | × |
| JPG | √ | × |
| PNG | √ | × |
| Binary Data | √ | × |
| CSV Data | √ | × |
| Matlab Data | √ | × |
| FileConverter | √ | × |
| Memory | √ | × |





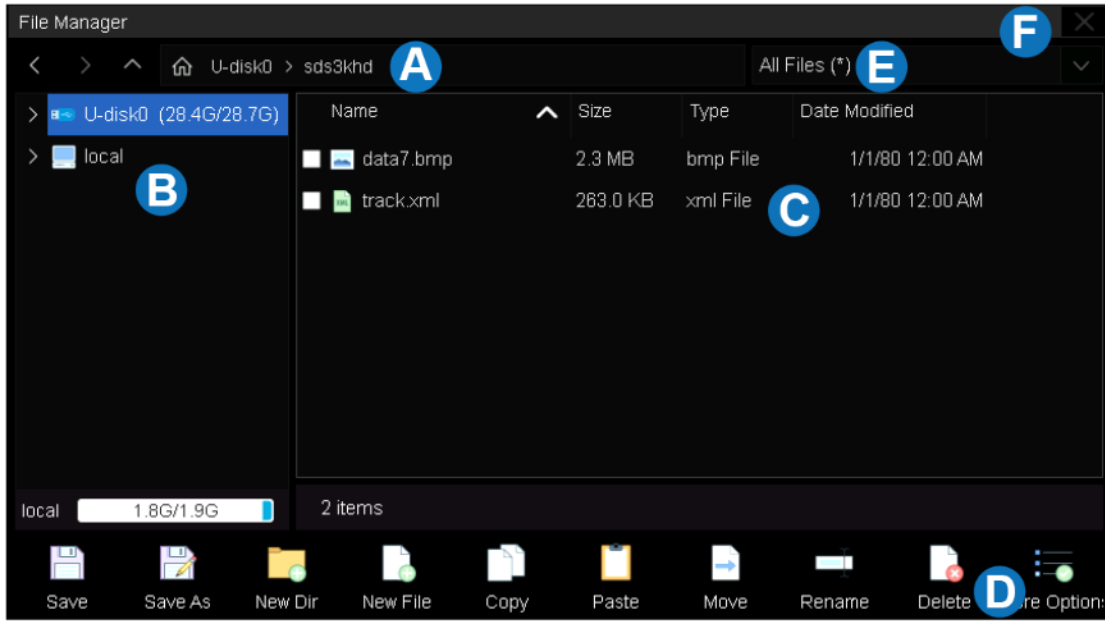

33.2 File Manager









The SDS3000X HD's file manager has a similar style and operation to the Windows® operating systems.



- A. Address bar
- B. Navigation panel
- C. File list
- D. Toolbar
- E. File type
- F. Close the file manager

Table 33.1 Description of icons in the file manager

| Icon | Description | Icon | Description |
|---|-------------|---|---------------|
|  | Back |  | New directory |
|  | Forward |  | New file |
|  | Up level |  | Copy |

| | | | |
|---|----------------|---|--------|
|  | Root directory |  | Paste |
|  | Save |  | Rename |
|  | Save as |  | Delete |
|  | Recall |  | Move |

33.3 Save and Recall Instances

Save the screenshot to the path “Udisk0\sds3khd\” in the format of BMP

First, Insert the U disk.

Secondly, set the parameters of the Save operation:

- Select Mode as "Save"
- Select Type as "BMP"
- Select the Image Style. "Normal" saves images with the same color of the display; "Inverted" saves images with a white background color to save ink during printing
- Select to include the menu in the Print Area or not. "No" only saves the grid area and descriptor boxes; "Yes" saves the whole display
- Touch File Manager to open the file manager

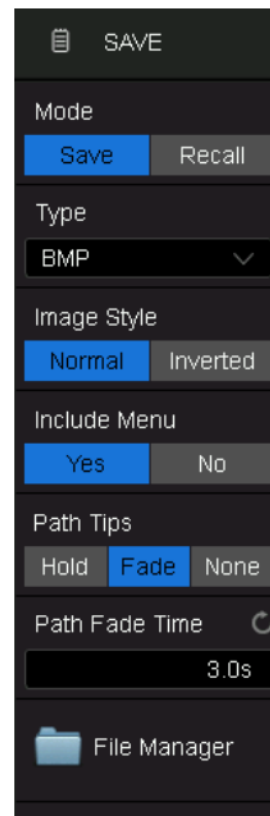

Third, select the “Udisk0\sds3khd\” directory in the file manager:

Fourth, touch **Save As** , click the pop-up text box to recall the virtual keyboard and input the file name, and then touch **OK** :

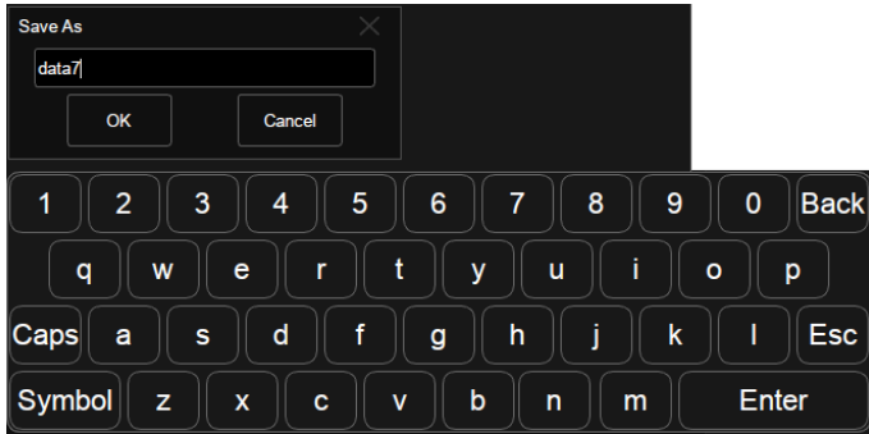

Once saved, the new BMP file is visible in the file manager:

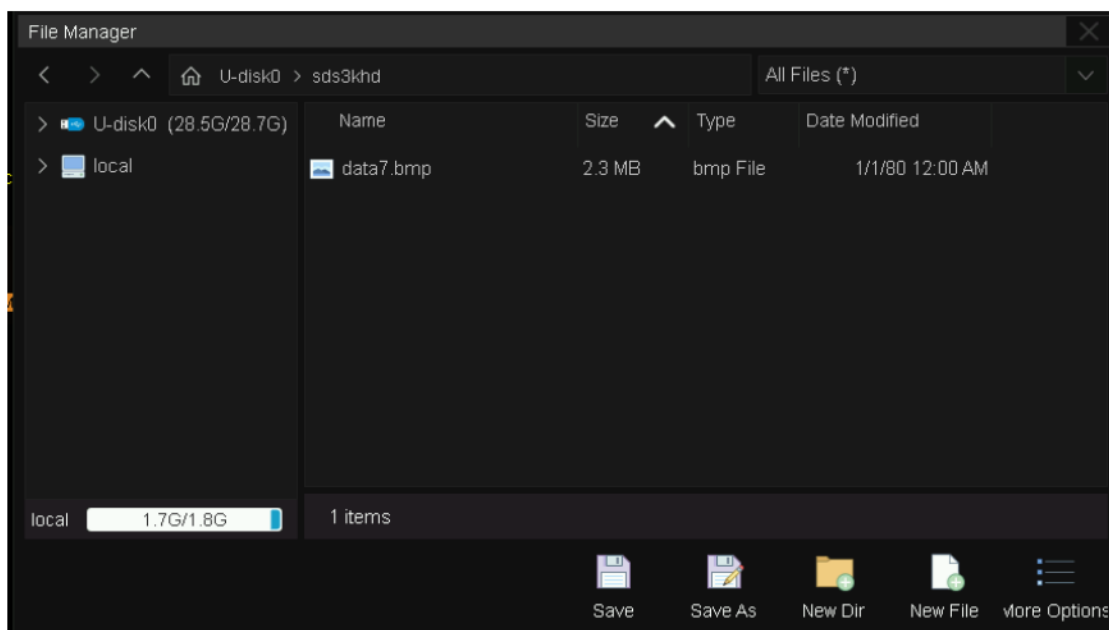

In step 4, if **Save** is selected instead of **Save As**, the system saves the file as the default file name SDS3xx4XHD_BMP_n.bmp, where n is an integer incrementing from 1. The default save path is \SIGLENT\.

Note: Touch **Utility** > **Print** to quickly save a screenshot to the path where the last screenshot is saved.

Note: When a file is saved successfully, a message will pop up to inform that it has been saved, and the filename of the next file to be saved is shown as well. The default naming strategy is to add an incremental number at the end of the first saved filename.

Note: A saved picture can be browsed on the oscilloscope by opening it in the File Manager.



Recall the setup file "track.xml" stored in path "Udisk0\sds3khd"

First, insert the U disk with the file "track.xml" stored folder "\sds3khd\".

Second, set the parameters of the Recall operation:

- Select **Mode** as "Recall"
- Select **Type** as "Setup"
- Touch **File Manager** to open the file manager

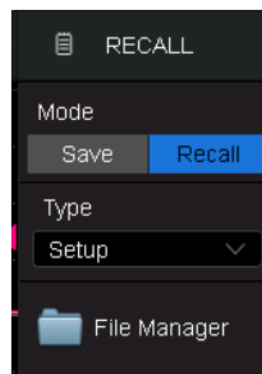

Third, select the "Udisk0\sds3khd\" directory in the file manager, and then select the setup file "track.xml"

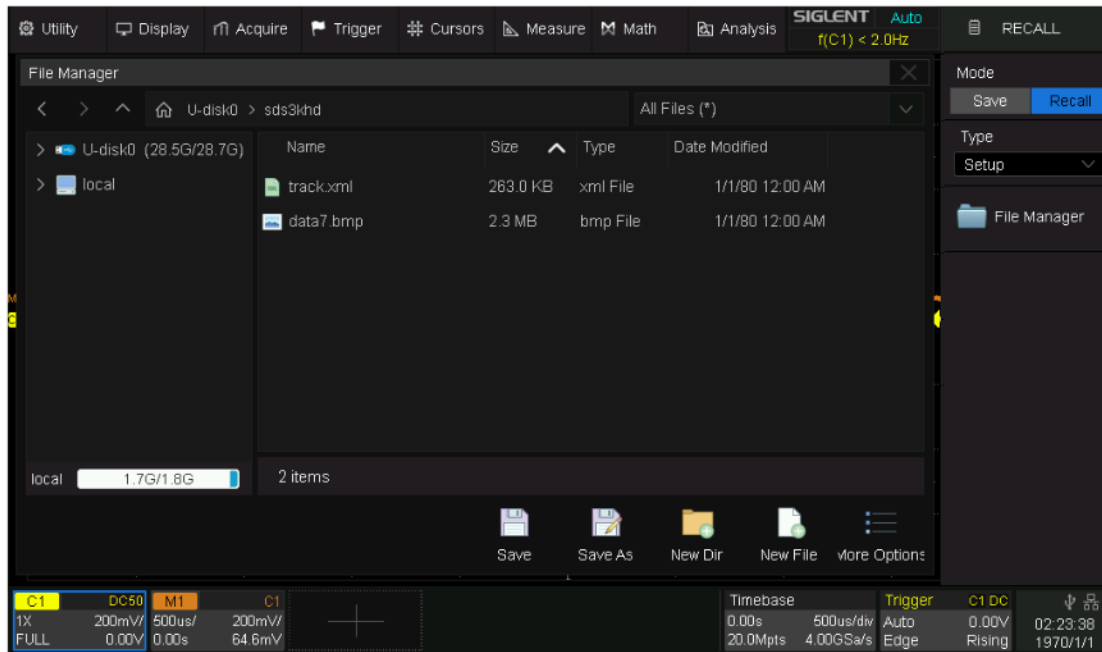

Fourth, touch the Recall icon  and wait for the oscilloscope to finish recalling the setup.

33.4 Quick Save and Screenshot

Users can use the **Save** button to quickly save files of the specified type (including screenshots). See the section "Save Button" for details.

For simple screenshot requirements, perform **Utility** > **Print** to quickly save screenshots.

34 Utility

34.1 System Information

Operate **Utility** > **Menu** > **System Info** to check the system status. System information includes the contents shown below.

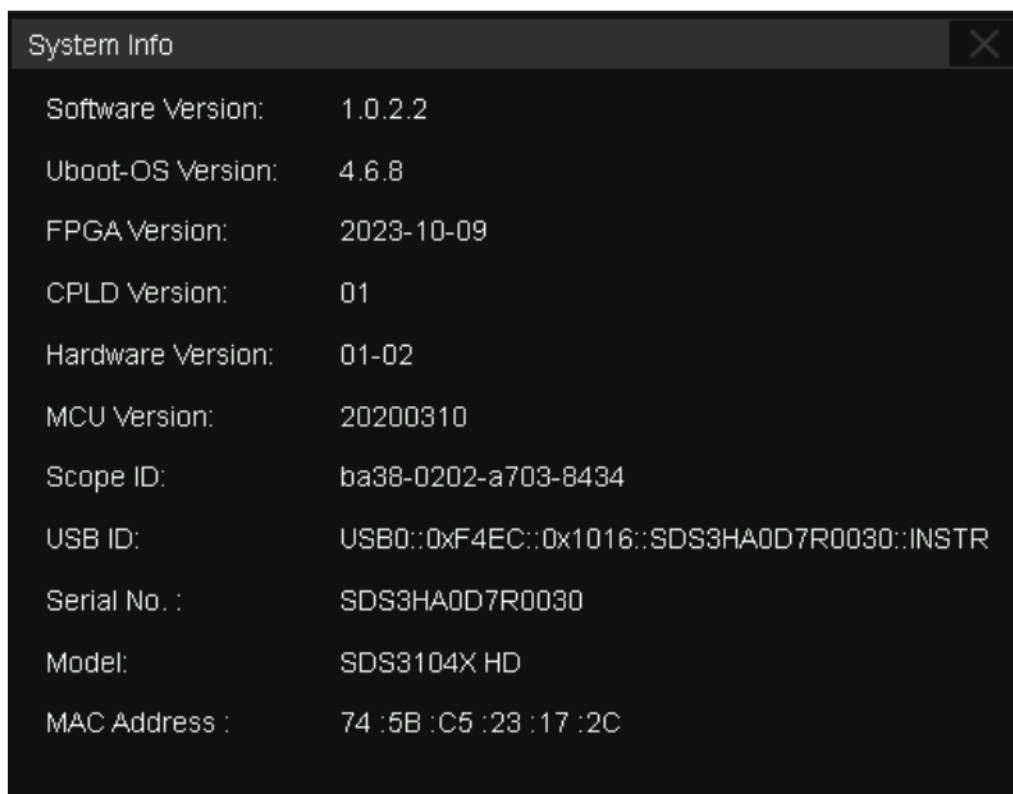

| System Info | |
|-------------------|---|
| Software Version: | 1.0.2.2 |
| Uboot-OS Version: | 4.6.8 |
| FPGA Version: | 2023-10-09 |
| CPLD Version: | 01 |
| Hardware Version: | 01-02 |
| MCU Version: | 20200310 |
| Scope ID: | ba38-0202-a703-8434 |
| USB ID: | USB0::0xF4EC::0x1016::SDS3HA0D7R0030::INSTR |
| Serial No. : | SDS3HA0D7R0030 |
| Model: | SDS3104X HD |
| MAC Address : | 74 :5B :C5 :23 :17 :2C |

34.2 System Setting

34.2.1 Language

The SDS3000X HD supports multiple languages, including Simplified Chinese, Traditional Chinese, English, French, Japanese, German, Spanish, Russian, Italian, Portuguese, and so on.

Operate **Utility** > **Menu** > **System Setting** > **Language** , and select the language in the list.

34.2.2 Screen Saver

The screen saver will be activated if the oscilloscope has not been operated for a period. At this time the backlight of the display is cut off to save power consumption.

Operate **Utility** > **Menu** > **System Setting** > **Screen Saver** to specify the period before screen saver, or select "Off" to disable the screen saver.

Any action from the mouse, touch screen, or front panel can trigger to exit the screen saver.

34.2.3 Beeper

Follow the steps **Utility** > **Menu** > **System Setting** > **Beeper** to enable or disable the audible buzzer.

34.2.4 Touch Screen

Perform **Utility** > **Menu** > **System Settings** > **Touch Screen** or press the **Touch** button on the front panel to enable the touch screen function. When the function is disabled, the instrument no longer responds to any touch operation, but still responds to the key and mouse operations, and the remote operations of the WebServer is not affected.

34.2.5 Auto Power-on

Operate **Utility** > **Menu** > **System Setting** > **Auto Power On** to set. See the chapter "Power on" for details.

34.2.6 Date/Time

The SDS3000X HD has an RTC clock, which helps to record absolute time information for

screenshots, history frames, and so on.

Operate **Utility** > **Menu** > **System Setting** > **Date/Time** to open the Date/Time dialog box:

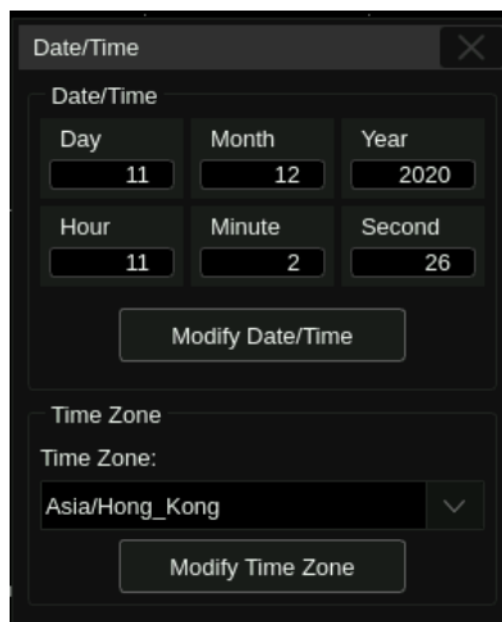

Touch the text box of Hour, Minute, Second, Day, Month, and Year to edit these fields. Touch the **Modify Date/Time** button to perform the change. Touch the text box of Time Zone to select the time zone. Touch the **Modify Time Zone** button to perform the change.

34.2.7 Reference Position Setting

The reference position is used to set the strategy of scaling on the horizontal and vertical axes, adapting to different requirements.

Operate **Utility** > **Menu** > **System Setting** > **Reference Pos** to open the dialog box, and choose the strategy for the offset value change in the vertical (or horizontal) direction when the vertical (or horizontal) scale is changed.

Horizontal Ref

- **Fixed Delay:** When the time base is changed, the horizontal delay value remains fixed. As the horizontal timebase scale is changed, the waveform expands/contracts around the center of the display
- **Fixed Position:** When the time base is changed, the horizontal delay remains fixed to the grid position on the display. As the horizontal time base scale is changed, the waveform expands/contracts around the position of the horizontal display.

Vertical Ref

- **Fixed Offset:** When the vertical scale is changed, the vertical offset remains fixed. As the vertical scale is changed, the waveform expands/contracts around the main X-axis of the display
- **Fixed Position:** When the vertical scale is changed, the vertical offset remains fixed to the grid position on the display. As the vertical scale is changed, the waveform expands/contracts around the position of the vertical ground position on the display.

Take Horizontal Ref as an example to demonstrate the scaling effect of different settings:

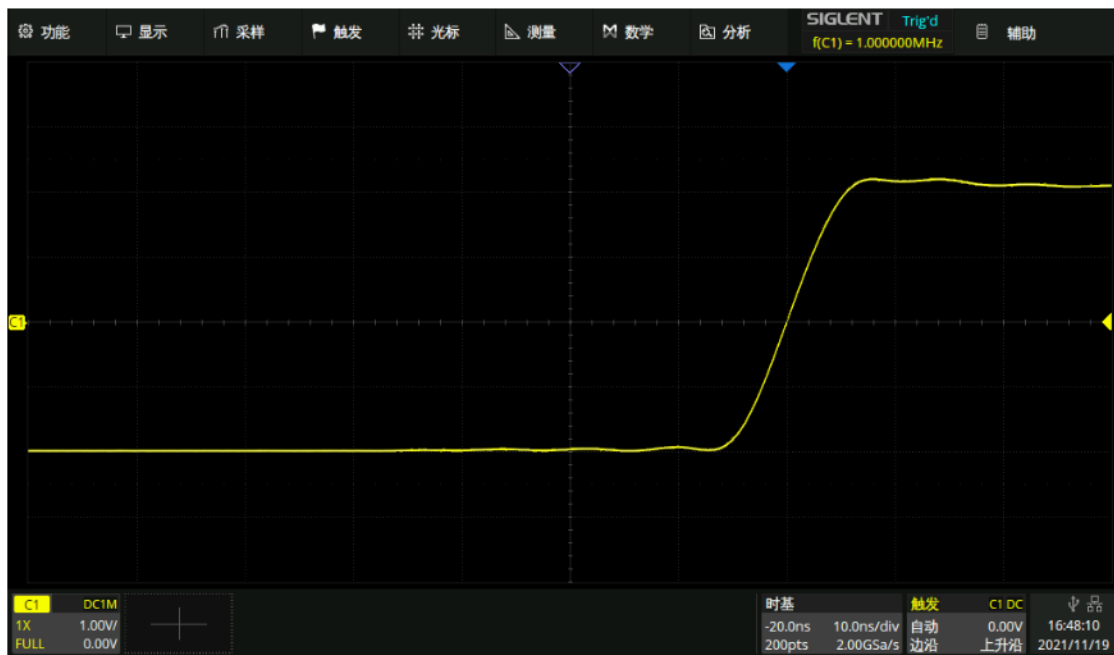

Timebase = 10 ns/div, Horizontal Delay = -20 ns = - 2 div

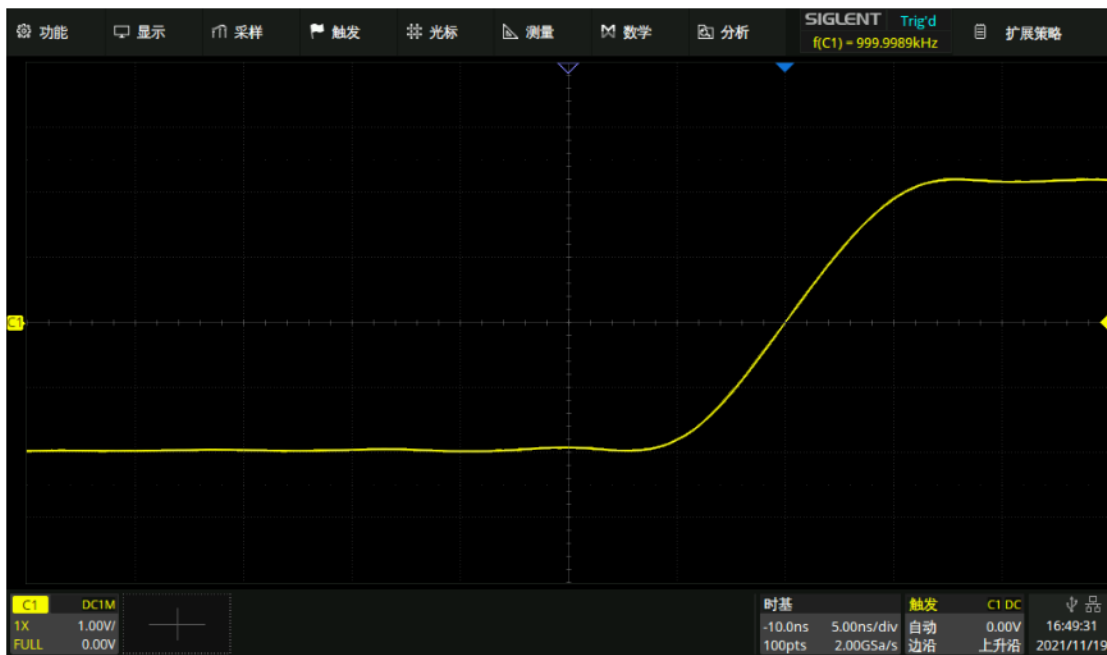

Fixed position, timebase is changed to 5 ns/div, the grid number of delay (2div) remains fixed, while the horizontal delay changes to -10 ns

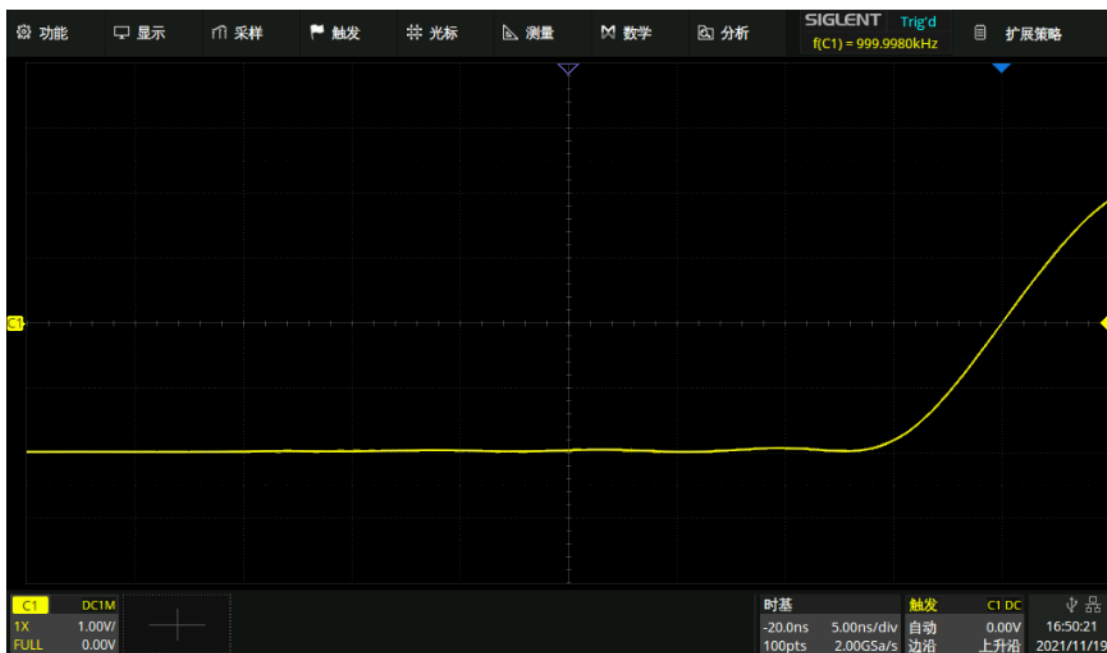

Fixed delay, timebase is changed to 5 ns/div, the horizontal delay value remains fixed, while the grid number of delay changes to 4div

34.3 I/O setting

34.3.1 LAN

Operate the following steps to set the LAN port:

Perform **Utility** > **Menu** > **I/O** > **LAN Config** to open the LAN Config dialog box.

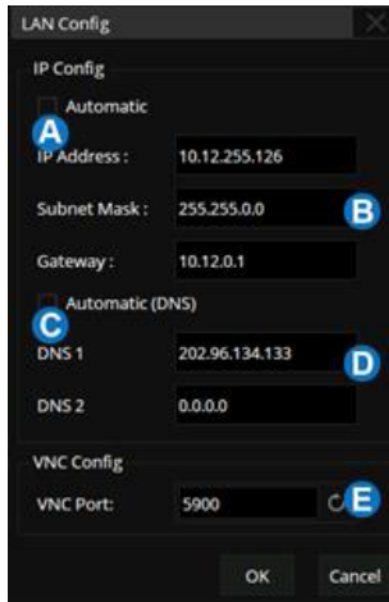

- A. Check **Automatic** to enable dynamic IP. In this case, the oscilloscope must be connected to the local area network with a DHCP server. Contact your network administrator to confirm the relevant information.
- B. When **A** is not checked, the oscilloscope uses static IP. Set the static IP address, subnet mask, and gateway separately.
- C. If your network provides Dynamic DNS, you can enable **Automatic (DNS)** to let the oscilloscope register its hostname and use the DNS server for name resolution.
- D. When **C** is not checked, set the DNS IP address manually
- E. When accessing more than two SIGLENT instruments through the web browser, it is necessary to set a different VNC port number for each instrument. The range is from 5900 to 5999.

34.4 Install Options

The SDS3000X HD provides a few options to enhance its functionality. Contact your local **SIGLENT** sales representative or **SIGLENT** technical support to get the corresponding option key. Perform the following steps to install the option:

Utility > **Menu** > **Software Options**

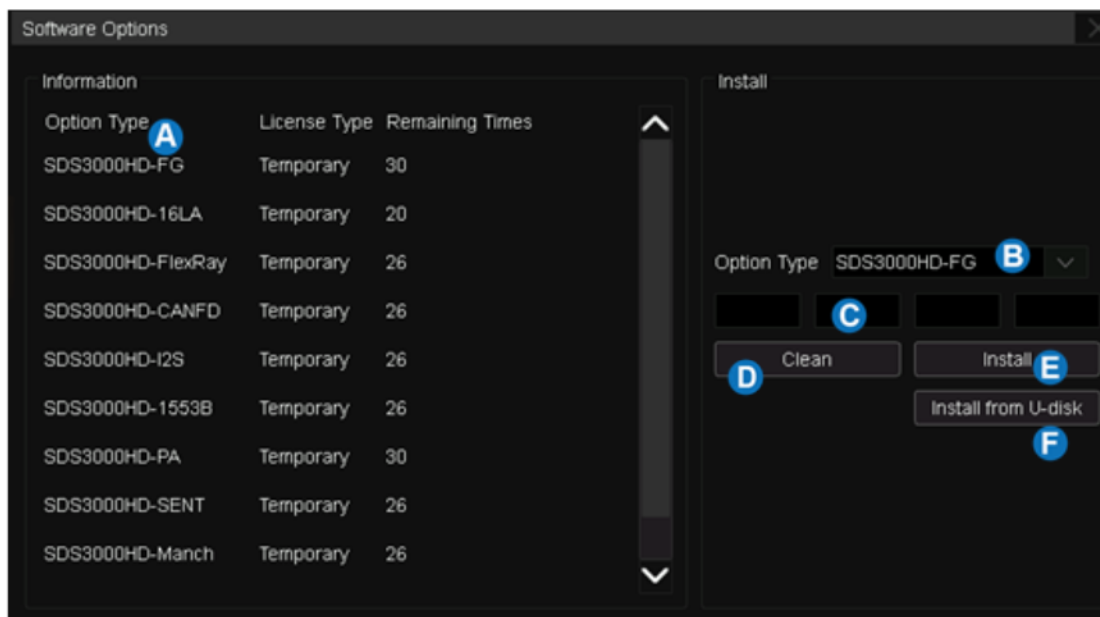

- A. Option information display area. When the option is not activated, the license type is displayed as "Temporary" and can be tried up to 30 times.
- B. Select the option to install.
- C. The option key input area, touch or click the text box and enter the key by the virtual keyboard.
- D. Clear the characters in the key input area.
- E. After entering the option key, click **Install** to perform the installation.
- F. Use the U-disk to automatically install the option, the license must be stored in the root directory of the U-disk.

34.5 Maintenance

34.5.1 Upgrade

The firmware is upgradeable through external USB memory devices/U disk. Make sure the U disk contains the correct upgrade file (*.ads) and is connected to the oscilloscope before performing the upgrade.

Operate **Utility** > **Menu** > **Maintenance** > **Upgrade** to recall the upgrade dialog box:

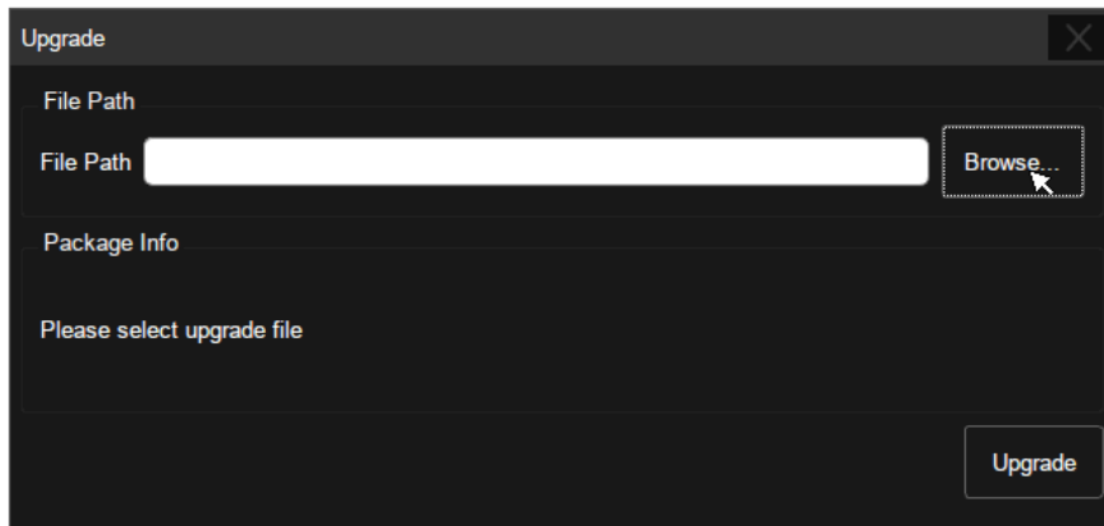

Click **Browse** to open the file manager, select the correct upgrade file and touch the Recall icon

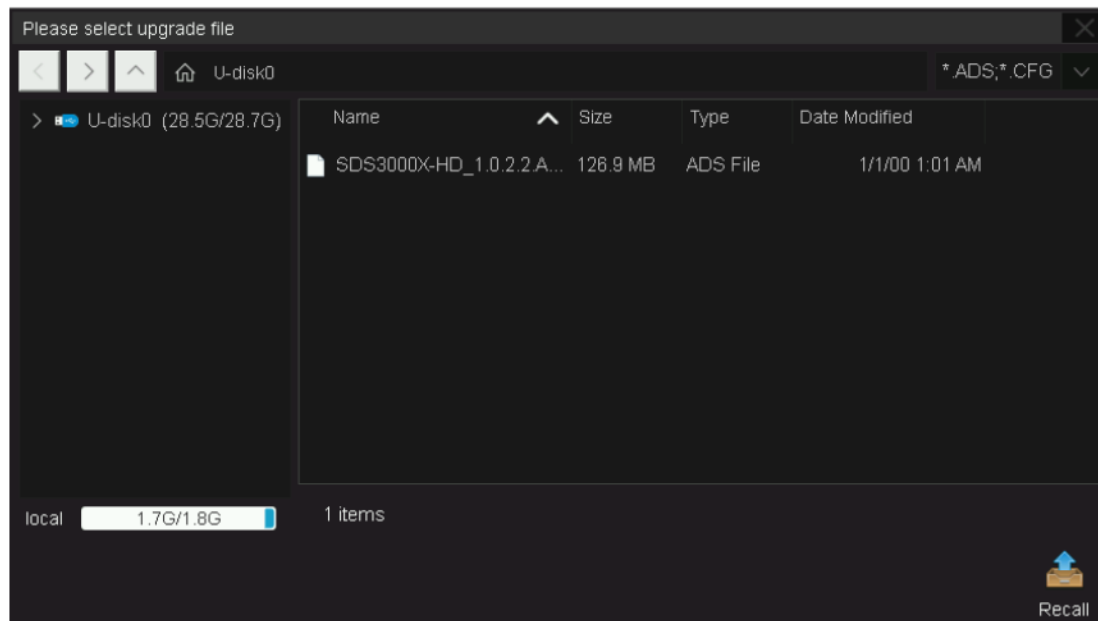

Click **Upgrade** in the upgrade dialog box to start the upgrade. The oscilloscope first copies the upgrade file (*.ads) to the local memory and parses it. If the parse succeeds, it will show the following

dialog. Users can choose **Cancel** to cancel the upgrade or **Reboot** to restart the oscilloscope immediately and continue the upgrade. Otherwise, the oscilloscope will restart automatically to finish the upgrade.

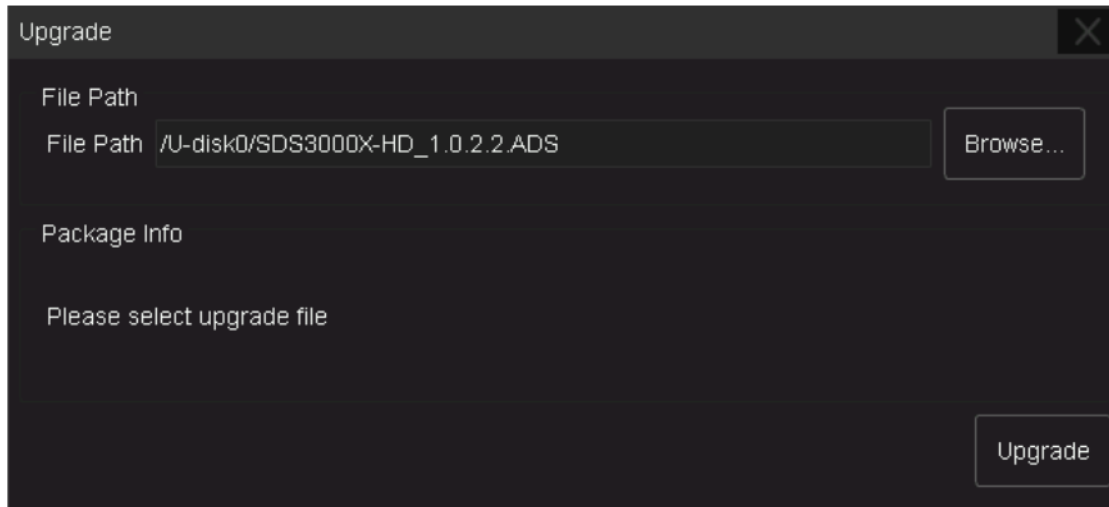

After the reboot, check if the version number is in "System Information".

| | |
|---|--|
|  | Warning: Do not turn off the power during upgrading. Otherwise, the oscilloscope may not boot up! |
|---|--|

34.5.2 Self-Test

The Self-tests include screen, keyboard, and LED tests. It is used to check whether the oscilloscope has any electrical or mechanical problems with the user interface such as color distortion, and the sensitivity of buttons and knobs.

Screen Test

The screen test is used to find out whether the oscilloscope display has serious color distortion, bad pixels, or screen scratches. Perform **Utility** > **Menu** > **Maintenance** > **Self Test** > **Screen Test**, and the oscilloscope will enter the screen test interface as shown below. The screen displays in blue at first.

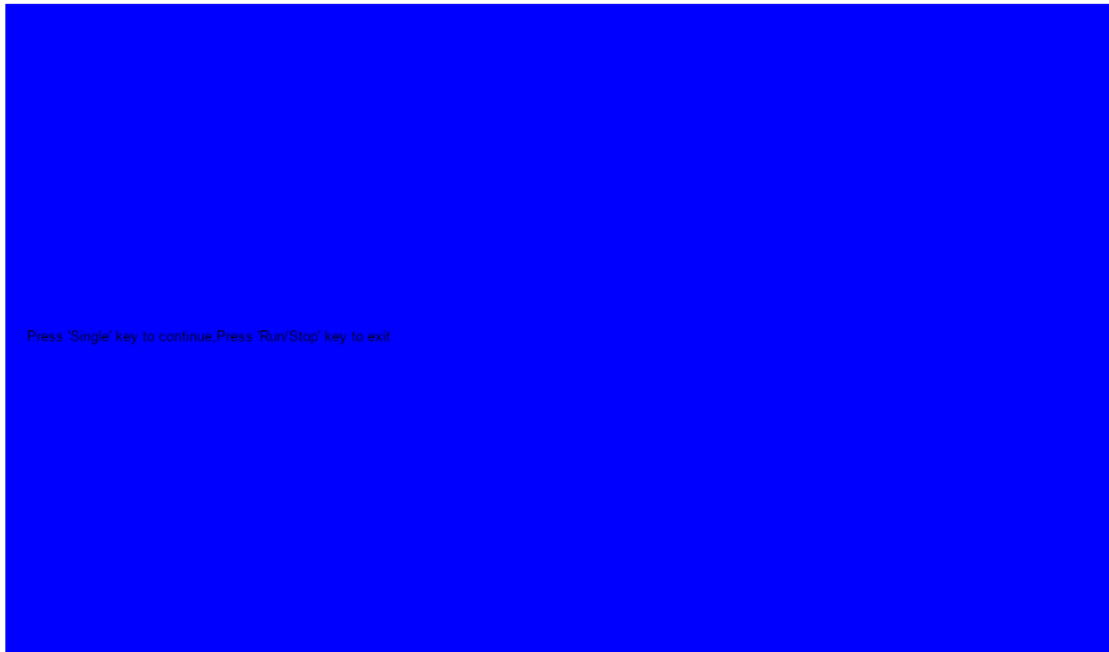

Press the "Single" button to switch to red and green display mode. Observe whether there is any color distortion, bad pixels, or scratches on the screen. Press the "Run/Stop" button to exit the screen test mode.

Keyboard Test

The keyboard test is used to check whether the oscilloscope front panel buttons or knobs are responsive or sensitive. Perform **Utility** > **Menu** > **Maintenance** > **Self Test** > **Keyboard Test** to recall the following interface:

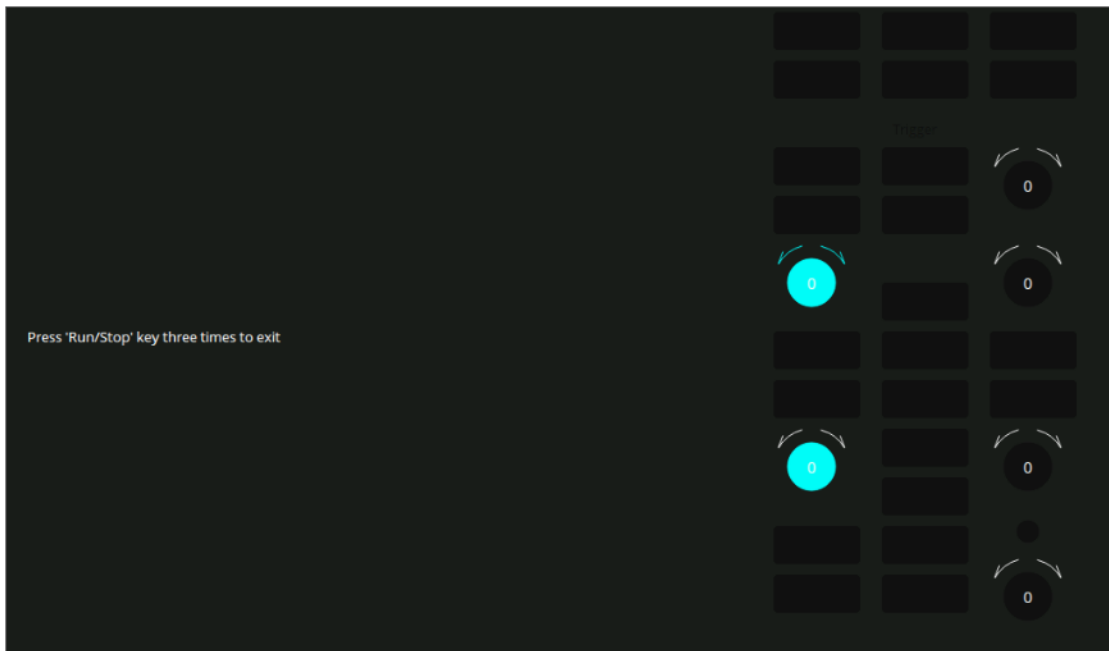

Knob test: Turn each knob clockwise, counter-clockwise, and press down. Observe whether the value on the corresponding knob (default 0) on the screen increases or decreases in real-time and whether the knob lights up when it is pressed.

Button test: Press each button and check whether the corresponding button icon on the screen lights up in real-time.

Press the "Run/Stop" button three times to exit the keyboard test.

LED Test

The LED test is used to check whether the button backlight on the front panel is functional. Operate **Utility** > **Menu** > **Maintenance** > **Self Test** > **LED Test** to recall the following interface:

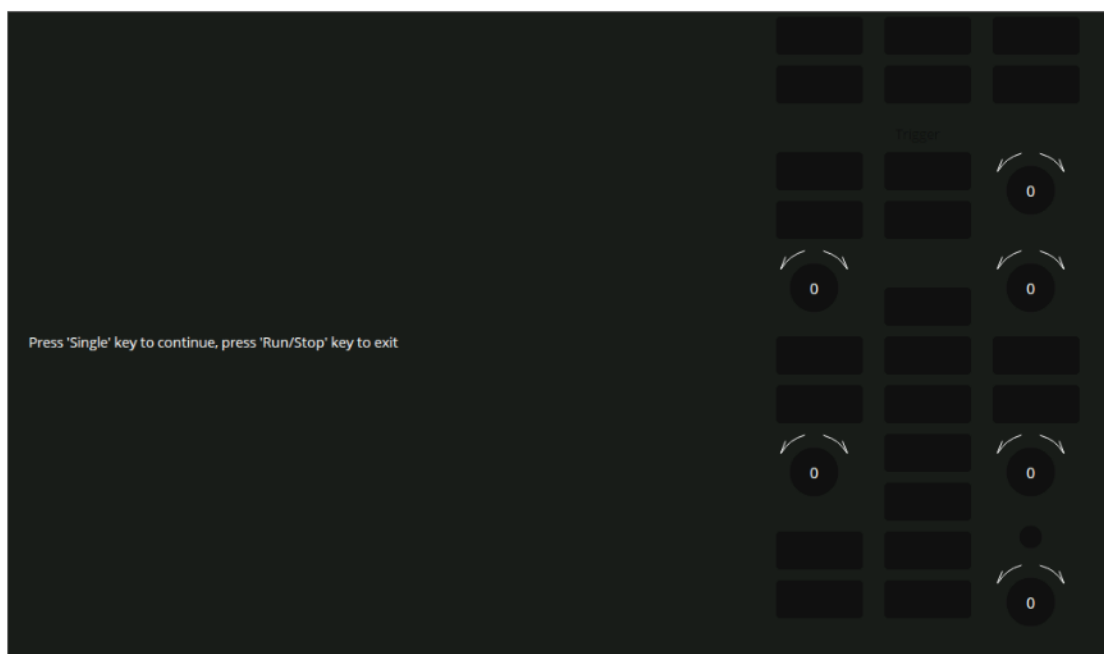

Press the "Single" button and the first LED on the front panel will light. The corresponding position of the key on the screen will also change color. Press the "Single" button to check the next button. Press the "Single" button consecutively until all the backlights are tested. Press the "Run/Stop" button to exit the LED test.

34.5.3 Self-Calibration

The self-calibration program can quickly calibrate the oscilloscope to reach the best working state and the most precise measurement. It is recommended to perform a self-calibration if the change of ambient temperature is more than 5 °C.

Note: Make sure the oscilloscope has been warmed up or operated for more than 30 minutes before the self-calibration.

Please do the self-calibration as follows:

1. Disconnect everything from all inputs.
2. Operate **Utility** > **Menu** > **Maintenance** > **Self Calibration** , and the following dialog box appears. Select **Continue** to start the self-cal program.

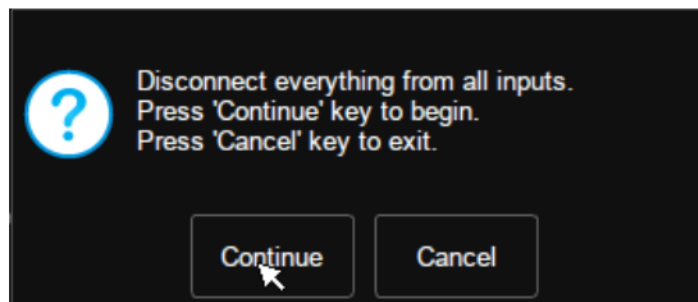

3. The oscilloscope will not respond to any operation until the self-cal is finished. After the self-cal is completed, touch the screen or press any button to exit.

34.5.4 Developer Options

This function is used for internal development by **SIGLENT**.

34.6 Service

34.6.1 LXI

This oscilloscope complies with LXI version 1.5, defined in LXI device specification 2016, which can be used to quickly build automated test systems.

Touch **LXI** to recall the LXI status box as below:

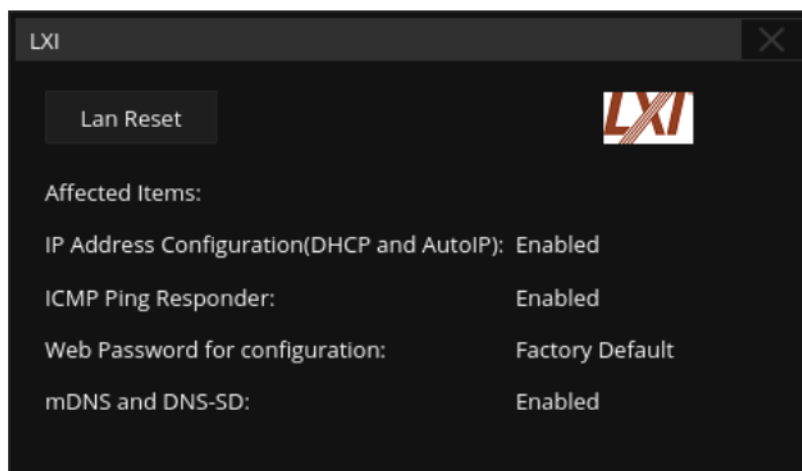

Touch **LAN Reset** to restore the LAN defaults to your oscilloscope. It will enable automatic IP, ICMP Ping responder, and Multicast DNS, and reset the webserver password which is set in **Utility > I/O > Web Server**.

After setting the LAN, the LXI welcome page can be loaded through the browser, refer to the section "LAN" and "Web Browser" for details. When starting instrument identification in the web server, the LXI image in the upper right corner will flash continuously.

34.6.2 SMB Files share

Perform **Utility > Menu > Service > SMB Files share** to enter the "Mount SMB File Share" interface. SDS3000X HD supports two types of SMB settings: Client and Server.

When the SDS3000X HD serves as Client, set the network storage path and the content related to access permissions, then the SDS3000X HD can store or recall files on the specified path. When the device being accessed in network access serves as Server, set up a shared directory and access permissions on the server, and then set up network storage on SDS3000X HD.

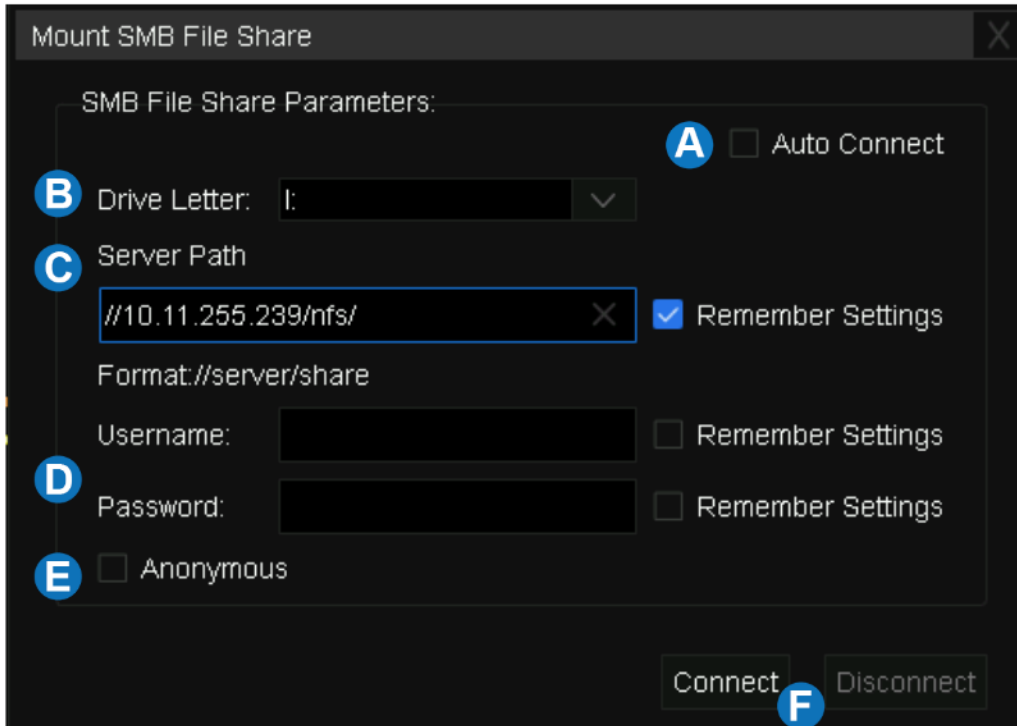

- A. Select "Auto Connect" to automatically connect to the server after each startup.
- B. Select the drive letter.
- C. Set the server path. Enter the path in the text box, and select "Remember Settings" to save the path.
- D. Enter user name and password in the text box.
- E. Select "Anonymous" to access the specified path in the default guest mode (username: Guest, password: none), and it needs to be set on the server to allow anonymous access.
- F. Manually connect or disconnect.

As Server, the IP address of the SDS3000X HD is automatically imported from the IP address obtained from LAN settings, and the username is fixed as "ShareUser", and user only needs to set the password and confirm the settings to access it.

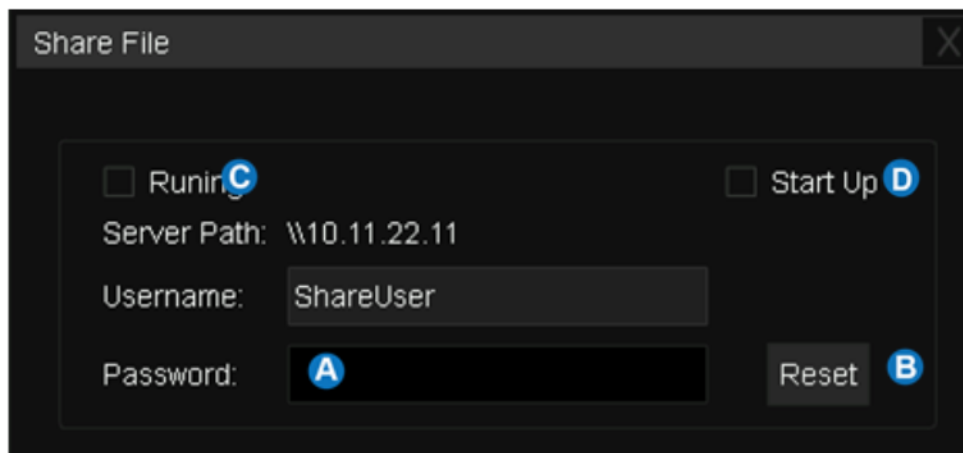

- A. Password setting area.
- B. Reset the password.
- C. When selected, file share service will take effect, otherwise it will not take effect.
- D. Check to automatically start up the share file at every power on.

34.6.3 Web Server

The SDS3000X HD includes a web server function, you can access and control the oscilloscope using a web browser. See the section "Web Browser" for details about remote control operation.

Perform **Utility** > **Menu** > **Service** > **Web** to set the password to control the instrument. The password length is limited to 20 bytes.

34.6.4 Emulation

When the "Emulation" option is set to "Tektronix", the SCPI command set of the instrument is changed to be compatible with Tek. This setting can help the user switch from a Tek scope with minimum changes to the existing code.

34.7 Save Button

Push the **Save** button on the front panel to perform the specified save action. The default is to save a screenshot as a picture (.bmp/.png/.jpg). Touch **Utility** > **Save Button** to set the file type and path.

- A. Select the save type: Screenshot or Save to
- B. When the save type is "Save to", set the save type referred to in the chapter "Save/Recall".

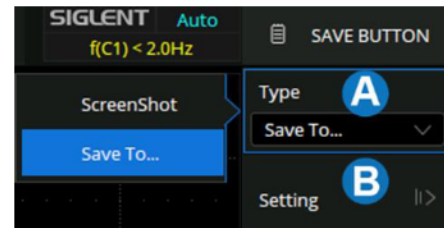

34.8 Quick Action

Push the **Quick Action** button on the front panel to perform a specified action. Touch **Utility** > **Quick Action** to open the **Quick Action** menu and set the action mapping to the button. For example, press the button to change the trigger source, or to turn color grading on. By default, Quick Action is disabled, and pushing the button for the first time will open the Quick Action menu.

- A. Enable/disable quick action. When disabled, pressing **Quick Action** will have no response
- B. Set the category. When set as "Analysis", the button can be preset as an analysis function switch; When set as "Edge trigger", the button can be preset to change some trigger parameters such as source and slope; When set as "Display", the button can be preset to change some display parameters such as color grade and persistence
- C. Set the action of this button under the selected category

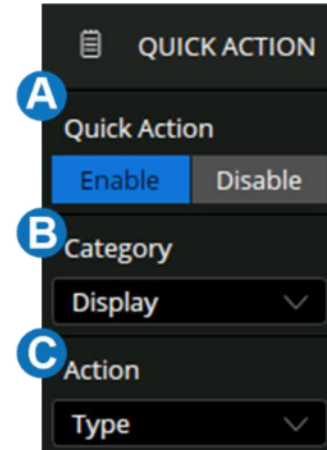

35 Troubleshooting

The commonly encountered failures and their solutions are listed below. When you encounter those problems, please solve them using the corresponding steps. If the problem remains, please contact **SIGLENT** as soon as possible.

1. The screen is still dark (no display) after power on:
 - 1) Check whether the power is correctly connected.
 - 2) Check whether the power switch is on.
 - 3) Check whether the fuse is burned out. If the fuse needs to be changed, please contact **SIGLENT** timely and return the instrument to the factory for replacement by the maintenance personnel authorized by **SIGLENT**.
 - 4) Restart the instrument after finishing the above inspections.
 - 5) If it still does not work correctly, please contact **SIGLENT**.

2. The signal is sampled but no waveform of the signal is displayed:
 - 1) Check whether the probe is correctly connected to the signal connecting wire.
 - 2) Check whether the signal connecting wire is correctly connected to the BNC (namely channel connector).
 - 3) Check whether the probe is correctly connected to the item to be tested.
 - 4) Check whether there are signals generated from the item to be tested.
 - 5) Resample the signal.

3. The tested voltage amplitude is greater or lower than the actual value (Note that this problem usually occurs when the probe is used):
 - 1) Check whether the attenuation coefficient of the channel complies with the attenuation ratio of the physical probe.
 - 2) Disconnect the oscilloscope from the external signal and do a self-cal.

4. There is a waveform display but not stable:
 - 1) Check the trigger signal source: check whether the source item at the trigger panel complies with the signal channel used.
 - 2) Check whether it is a "false wave": when the signal frequency is very large (more than half of the sample rate), it is easy to appear as a "false wave". At this point, a small time base should be set to make the sample rate more than 2 times the signal frequency.
 - 3) Check the trigger type: general signals should use the "Edge" trigger and video signals should use the "Video" trigger. Only when the proper trigger type is used, can the waveform be displayed stably.

- 4) Change the trigger holdoff setting.
5. No display after pressing **Run/Stop** :
Check whether the mode at the trigger panel (TRIGGER) is on “Normal” or “Single” and whether the trigger level exceeds the waveform range. If yes, set the trigger level to the middle or set the mode to “Auto”.
Note: Using **Auto** could automatically finish the above setting.
6. The touch screen does not respond to touch operation:
 - 1) Check whether the **Touch** button backlight on the front panel is lighted up. If not, the touch screen is not turned on. Press the button to enable the touch screen
 - 2) Restart the instrument.
7. The USB storage device cannot be recognized:
 - 1) Check whether the USB storage device can work normally.
 - 2) Make sure whether the USB interface can work normally.
 - 3) Make sure that the USB storage device being used is flash storage type. This oscilloscope does not support hardware storage type.
 - 4) Make sure that the U disk system format is FAT32.
 - 5) Restart the instrument and then insert the USB storage device to check it.
 - 6) If the USB storage device still cannot be used normally, please contact **SIGLENT**.



About SIGLENT

SIGLENT is an international high-tech company, concentrating on R&D, sales, production and services of electronic test & measurement instruments.

SIGLENT first began developing digital oscilloscopes independently in 2002. After more than a decade of continuous development, SIGLENT has extended its product line to include digital oscilloscopes, isolated handheld oscilloscopes, function/arbitrary waveform generators, RF/MW signal generators, spectrum analyzers, vector network analyzers, digital multimeters, DC power supplies, electronic loads and other general purpose test instrumentation. Since its first oscilloscope was launched in 2005, SIGLENT has become the fastest growing manufacturer of digital oscilloscopes. We firmly believe that today SIGLENT is the best value in electronic test & measurement.

Headquarters:

SIGLENT Technologies Co., Ltd
Add: Bldg No.4 & No.5, Antongda Industrial
Zone, 3rd Liuxian Road, Bao'an District,
Shenzhen, 518101, China
Tel: + 86 755 3688 7876
Fax: + 86 755 3359 1582
Email: sales@siglent.com
Website: int.siglent.com

North America:

SIGLENT Technologies America, Inc
6557 Cochran Rd Solon, Ohio 44139
Tel: 440-398-5800
Toll Free: 877-515-5551
Fax: 440-399-1211
Email: info@siglentna.com
Website: www.siglentna.com

Europe:

SIGLENT Technologies Germany GmbH
Add: Staetzlinger Str. 70
86165 Augsburg, Germany
Tel: +49(0)-821-666 0 111 0
Fax: +49(0)-821-666 0 111 22
Email: info-eu@siglent.com
Website: www.siglenteu.com

Follow us on
Facebook: SiglentTech

