User Manual

SHS1000 Series Handheld Digital Oscilloscope

UM03010-E07C

Declaration

Copyright © SIGLENT TECHNOLOGIES CO.,LTD. All rights reserved.

Contents in this manual are not allowed to copied, extracted and translated
without permission by the company.

Safety Information

Carefully read the following safety information before using the SHS1000.

Specific warning and caution statements, where they apply, appear throughout the manual.

A “Warning” identifies conditions and actions that pose hazard(s) to the user.

A “Caution” identifies conditions and actions that the user should notice.

The following international symbols are used on the SHS1000 and in this manual:



**Hazardous
Voltage**



**Protective
Earth Ground**



Warning



Earth Ground



**Power
Switch**

- ◆ Use only insulated voltage probes, test leads and adapters supplied with the SHS1000, or accessories appointed by the company.
- ◆ Before use inspect voltage probes, test leads and accessories for mechanical damage and replace when damaged.
- ◆ Always connect the battery charge first to the AC outlet before connecting it to the SHS1000.
- ◆ Do not apply voltages that higher than 600 V from earth ground to any input when using scope ports in a CAT III environment. Do not apply voltages that higher than 1000 V from earth ground to any input when using scope ports in a CAT II environment.
- ◆ Do not apply voltages that higher than 600 V from earth ground to the isolated inputs when using scope ports in a CAT III environment. Do not apply voltages that higher than 1000 V from earth ground to the isolated inputs when using scope ports in a CAT II environment.
- ◆ Do not apply input voltages above the rating of the instrument. Use caution when using 1:1 test leads because the probe tip voltage will be directly transmitted to the SHS1000.
- ◆ Do not apply voltages that higher than 600 V from earth ground to any input when using multimeter ports in a CAT III environment. Do not apply voltages that higher than 1000 V from earth ground to any input when using multimeter ports in a CAT II environment.
- ◆ Do not apply voltages that higher than 600 V from earth ground to the isolated inputs when using multimeter ports in a CAT III environment.

Do not apply voltages that higher than 1000 V from earth ground to the isolated inputs when using multimeter ports in a CAT II environment.

- ◆ **Do not insert metal objects into connectors.**
- ◆ **Always use the SHS1000 only in the manner specified.**

The terms 'isolated' is used in this manual to indicate a measurement in which the SHS1000 input BNC or banana jacket is connected to a voltage different from earth ground. The isolated input connectors have no exposed and are fully insulated to protect against electrical shock.

Use of the SHS1000 in a manner not specified may impair the protection provided by the equipment. Before use, inspect the test leads for mechanical damage and replace damaged test leads!

Whenever it is likely that the safety has been impaired, the SHS1000 must be turned off and disconnected from the line power. The matter should then be referred to qualified personnel.

Introduction of SHS1000 Series Handheld Digital Oscilloscope

This manual mainly introduces SHS1000 series Handheld Digital Oscilloscope.

Adopting bandwidth isolation technique, SHS1000 realizes that all input ports are isolated so that high-voltage signals can be measured safely. This series combines functions of scope, multimeter and recorder. It provides real time sampling rate as high as 1GSa/s, maximal bandwidth 100MHz, 2Mpts memory depth, small volume, compact interface and etc. It satisfies the most needs of outside measurement and improves working efficiency greatly.

Function Characteristics

- ◆ The SHS1000 combines the functions of oscilloscope, multimeter and recorder (including trend plot and waveform recorder) along with isolated double channels.
- ◆ Adopt bandwidth isolation technique, SHS1000 realizes that both scope and multimeter input channels' isolation.
- ◆ CATII1000V and CATIII600V between two channels references, between channels reference and earth ground
CATII600V and CATIII300V between channels reference and Multimeter input reference
- ◆ CATII300V and CATIII150V input direct
CATII1000V and CATIII600V input with 10: 1 probe
- ◆ 5.7 inches color TFT LCD.
- ◆ It provides maximal bandwidth 100MHz, real time sample rate 50GSa/s, memory depth 2Mpts.
- ◆ The multimeter display resolution is 6000 points and can measure voltage, current, resistance, capacitance, diode, continuity.
- ◆ Support scope measure parameters trend plot, multimeter measure parameter trend plot and scope waveform recorder.
- ◆ 3 types of trigger mode: auto, normal and single; 5 types of trigger function: edge, pulse, video, slope and alternative.
- ◆ 32 types of auto-measurement function and 3 types of cursor measure mode.
- ◆ 4 kinds of digital filter mode: +, -, *, /, FFT.

- ◆ Unique digital filter function and waveform recording function.
- ◆ 2 groups of reference waveform, 20 groups of common waveform, 10 groups of setting inside save / recall; Support waveform, setting, CSV and bitmap file save and recall with USB flash driver.

Accessories of SHS1000

- ◆ A Quick Start
- ◆ A product guaranty card
- ◆ A certification
- ◆ Two 10:1 probes
- ◆ An USB cable
- ◆ A Probes calibrated device
- ◆ A CD (including EasyScope3.0 computer software system)

Contents

Safety Information	II
Introduction of SHS1000 Series Handheld Digital Oscilloscope	IV
Function Characteristics	IV
Accessories of SHS1000	V
Chapter 1 Accidence	1
Accidence of the Front Panel and User Interface	1
Function Check.....	4
Probe.....	4
Chapter 2 Using the Scope	6
Menu and Control Buttons	6
Automatic Settings.....	7
CH1/CH2 Channel Functions	7
Scope's Function Menu.....	10
Acquire Signals System	10
Display System	12
Math Waveform.....	14
Horizontal System.....	16
Reference waveform	18
Cursor and Measure System.....	19
Cursor measure	19
Parameter Measure.....	21
Trigger System.....	26
Save and Recall System.....	34
Utility System	38
Chapter 3 Using the Multimeter	44
Making DC and AC Voltage Measurement.....	45
Making Resistance Measurement.....	46
Making Diode Measurement.....	47
Making Continuity Measurement.....	47
Making Capacitance Measurement.....	48
Making DC and AC Current Measurement.....	49
Chapter 4 Using the Recorder Functions	51
Oscilloscope Trend Plot	52
Waveform Recorder	55
Multimeter Trend Plot.....	58
Chapter 5 Prompting and Troubleshooting	61
System Prompting Messages Instruction	61
Troubleshooting	63

Chapter 6 Service and Support.....	65
Maintain Summary.....	65
Contact SIGLENT.....	65
Appendix A: Default Setup.....	69
Appendix B: Battery Installation.....	71
Appendix C: Daily Maintaining and Cleaning.....	72

Chapter 1 Accidence

About this Chapter

This chapter mainly covers the following contents:

- ◆ Get a primary understanding of the front panel and user interface
- ◆ A brief function check
- ◆ Probe compensation

Accidence of the Front Panel and User Interface

You'd better get an understanding of the front panel before you operate the SHS1000 series Handheld Digital Oscilloscope. The following contents introduce the function of the front panel. With its help you could be familiar with the operations of the SHS1000 in a short time.



Figure 1-1 Front Panel

Description

- | | |
|---|--|
| 1. power on/off key | 10. menu on/off key |
| 2. CH1 vertical range and position key | 11. arrow keys |
| 3. CH1 on /off key | 12. Auto, Run/Stop, Cursor function keys |
| 4. Scope, Meter, Recorder function menu | 13. CH2 on/off key |
| 5. option keys | 14. Trigger, User, Save/Recall function keys |
| 6. Handle | 15. CH2 vertical range and position keys |
| 7. LCD | 16. time base and horizon position keys |
| 8. LOGO | 17. multimeter input ports |
| 9. BW and sample rate | |

Notes:

The arrow keys include these functions: direction keys, moving trigger level, setting the trigger level to zero, choosing menu, setting horizontal position to zero, moving cursor.



Figure 1-2 Isolated Inputs Channels



Figure 1-3 Side Panel

Description

1. USB Device
2. USB Host
3. power input port

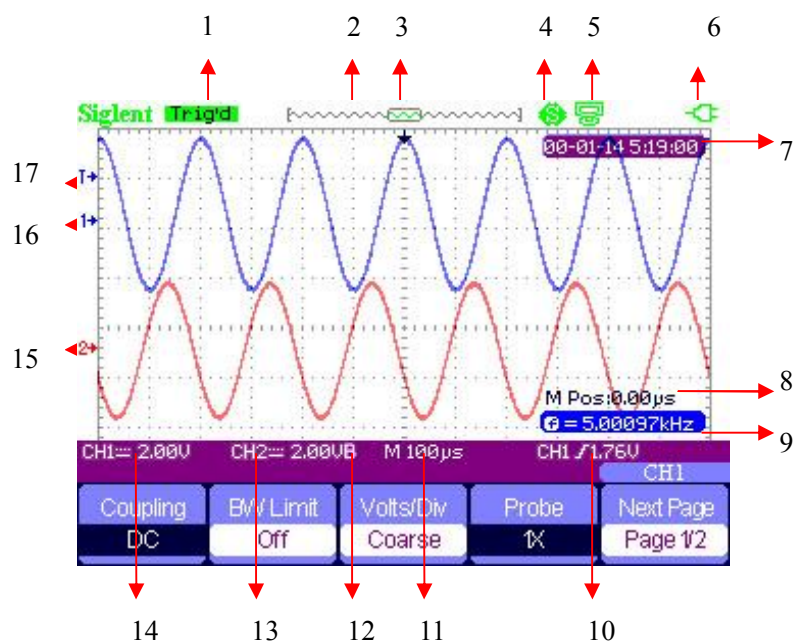

Figure 1-4 User Interface

Description

1. Trigger state

Armed: The scope is acquiring data of pre-trigger, please ignore all triggers under this state.

Ready: The scope has sampled all pre-triggers data and is ready to accept trigger.

Trig'd: The scope has found a trigger and is sampling data after trigger.

Stop: The scope stops sampling data.

Auto: The scope is sampling waveform without trigger under automatic mode.

Scan: The scope samples and displays waveform under scan mode.

2. Shows location of current waveform in the memory

3. Shows the trigger position in the memory

4. : **Print Key** option chooses to **print figure**

: **Print Key** option chooses to **save figure**

5. : **USB Device** option chooses to connect **computer**

: **USB Device** option chooses to connect **printer**

6. Shows power state

12. "B" shows the BW limited is on

7. Shows current time

13. Channel's vertical range

8. Horizontal position

14. Channel's coupling states

9. Frequency Counter

15. "2" is a symbol of channel 2

10. Shows the trigger level

16. "1" is a symbol of channel 1

11. Shows the time base

17. "T" shows the trigger level

Function Check

Let's make a quick function check to make sure whether the SHS1000 works normally. Please do the following steps:

1. Power the SHS1000. The SHS1000 performs all the self check items and makes sure that it passes the self check.
2. Connect the probe to the **CH1** of the SHS1000. Align the slot of the probe connector with the salient on the CH1 BNC, push down and twist right to lock the probe. Connect the probe tip and reference lead to the **Probe Comp** connectors.
3. Press **【Auto】**, you will see a square wave with 1 KHz frequency and about 3V peak-peak in a few seconds.
4. Press **【CH1】** twice to cancel channel 1, then press **【CH2】** to display channel 2 and repeat step 2 and 3.

Probe

Probe Safety

There is high-voltage protected material around the probe and no metal exposed to the air. Don't use probe with broken insulation.

Probe Compensation

When you connect the probe to an arbitrary channel for the first time, please make the following adjustment to make the probe match with the channels. Probe without compensation or compensation warp may lead to imprecise or false measurements. You can perform the adjustments manually to match your probe with the input channels.

1. Set the probe option attenuation in the channel menu to 10X and connect the probe to channel 1 on the scope. If you use the probe hook-tip, make sure that the hook-tip is fixed on the probe firmly.
2. Attach the probe tip to the **Probe Comp~3V** connector and the reference lead to the **Probe Comp Ground** connector. Display the channel and then push button **【Auto】**.
3. Check the shape of the waveform displaying on the screen.

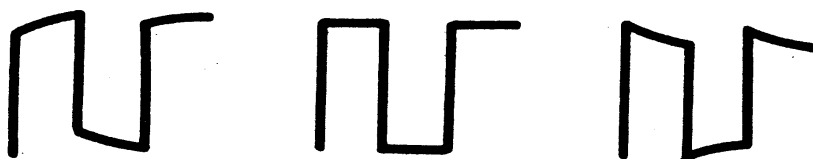

Under Compensated

Correctly Compensated

Over Compensated

4. Please adjust your probe or repeat all the operations above if necessary.

Multimeter meter pen

To avoid obtaining no measurements or unnecessary damage to the SHS1000, you should use the right jack when measuring current, voltage and other measure.

Chapter 2 Using the Scope

About this Chapter

This chapter provides a step-by-step introduction to the scope functions of SHS1000 series. The introduction gives basic examples to show how to use the menus and perform basic operations without covering all of the capabilities of the scope functions.

In order to use the SHS1000 effectively, we need to know the functions of the SHS1000 below. Menu and control buttons, connector and control, auto-settings, Scope, measurement system, trigger system, storage system and utility system.

Menu and Control Buttons

Table 2-1 Function Menu

CH1, CH2	channel menu
Acquire	sample menu
Display	display menu
Math	math menu
Horizon	horizon menu
Ref	reference waveform menu
MEAU OFF	on/off menu
Auto	automatic setting control menu
Run/Stop	sample/Stop button
Cursor	cursor menu
Measure	automatic measurement menu
Trigger	trigger menu
Save/Recall	save/Recall menu
User	utility menu

Automatic Settings

When measuring unknown signals and having no idea about its voltage, range, frequency, trigger and other information, you can use the automatic setting function.

Automatic Setting Application Example

Operating steps:

1. Input a signal to CH1 or CH2 and then press **【Auto】**.
2. The SHS1000 adjusts its settings automatically to display the best peak-peak, average, period, frequency and other information according to the characteristics of the signals.
3. Adjust time base and voltage range manually to obtain waveforms needed if necessary.

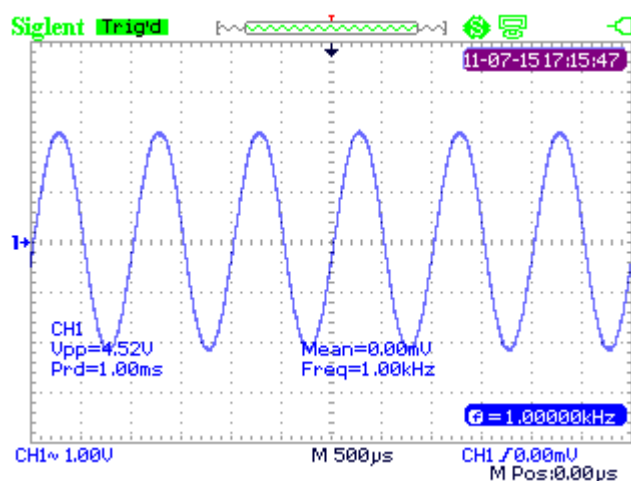

Figure 2-1 Automatic Setting

CH1/CH2 Channel Functions

Press **【CH1】** / **【CH2】** to enter CH1/CH2 channel menu.



Figure 2-2 Channel Menu 1

Table 2-2 CH1/CH2 function Menu 1

Option	Setting	Instruction
Coupling	DC	DC passes both AC and DC components of the input signals.
	AC	AC blocks the DC component of the input signals and attenuates signals below 10 Hz.
	GND	GND disconnects the input signal.
BW Limit	On Off	Limit the bandwidth above 20M to reduce display noise; filter the signals to reduce noise and other unwanted high frequency components.
V/div	Coarse	Change the range of voltage by .1-2-5 sequence.
	Fine	Fine changes the resolution by small steps under the coarse settings.
Probe	1X、5X、10X、50X、100X、500X、1000X	Set to match the type of probe you are using to ensure correct vertical readouts.
Next Page	Page1/2	Enter the second page of CH1/CH2 menu.



Figure 2-3 Channel Menu 2





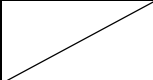

Table 2-3 CH1/CH2 Function Menu 2

Option	Setting	Instruction
Invert	On/Off	Turn on/off invert function.
Filter		Enter the FILTER menu.
To Zero		Set waveform vertical position and trigger level to zero.
Next Page	Page 2/2	Return to the first page of CH1/CH2 menu.



Figure 2-4 Digital Filter Function Menu

Table 2-4 Digital Filter Function Menu

Option	Setting	Introduction
Digital Filter	On	Turn on the digital filter.
	Off	Turn off the digital filter.
Type		Setup as LPF (Low Pass Filter).
		Setup as HPF (High Pass Filter).
		Setup as BPF (Band Pass Filter).
		Setup as BRF (Band Reject Filter).
Up_Limit		Use the up and down arrow keys to set Up_Limit.
Low_Limit		Use the up and down arrow keys to set Low_Limit.
Return		Return to the CH1 or CH2 menu.

Digital Filter Application Example

Operation steps:

1. Input a signal to CH1 and press **【AUTO】**.
2. Press **【CH1】** to enter CH1 menu.
3. Press **【F5】** to enter the second page of the CH1 menu.
4. Press **【F3】** to enter the digital **Filter** function.
5. Press **F2** to choose a filter type. For example: input a signal with BW 20M and choose **Up_Limit**.
6. Use up and down arrow keys to set the filter range.
7. Press **【F1】** to turn on the filter

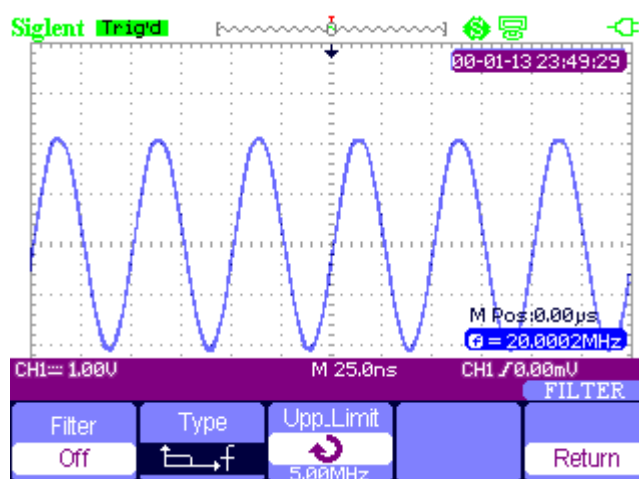

Figure 2-5 Before Turn On the Digital Filter

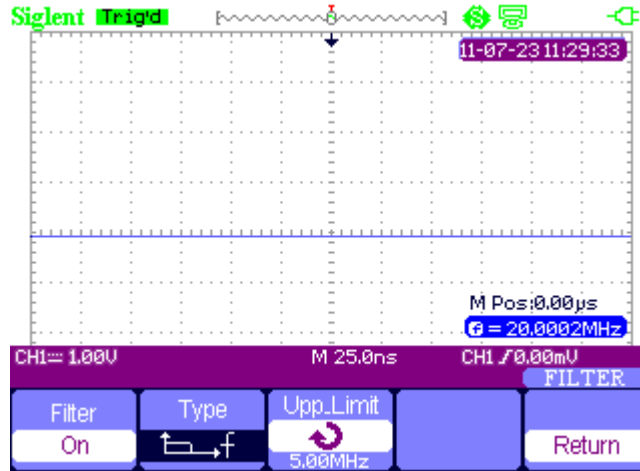

Figure 2-6 After Turn On the Digital Filter

Scope's Function Menu

The button **【Scope】** includes the following functions:

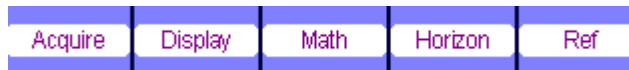

Figure 2-7 Scope Function Menu

Acquire Signals System

Press **【Scope】** and choose **Acquire** to enter acquiring system. See Figure 2-8.

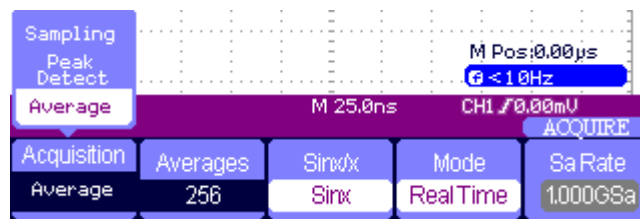

Figure 2-8 Acquire Signals system function menu

Table 2-5 Acquiring Signals System Function Menu

Option	Setting	Introduction
Acquisition	Sampling	Sample and display most waveforms accurately.
	Peak Detect	Detect burr and reduce fake wave phenomena.
	Average	Reduce random and irrelative noise.
Averages	(4, 16, 32, 64, 128, 256)	Select the times of averages.
Sinx/x	sinx	Use sin interpolation
	x	Use liner interpolation
Mode	Equ time	Set the Sampling mode to Equ time.
	Real time	Set the Sampling mode to Real time.
Sa Rate		Display system sampling rate.

Sampling: To construct the waveform, the scope samples the signals in equal interval.

Peak Detect: The scope captures the maximum and minimum values of the signals in every interval to display the waveform.

Average: The scope acquires several waveforms, averages them, and displays the final waveform. The more average times the smoother of the waveform.

Equivalent Time Sampling: This mode is good for observing repetitive period waveforms. The sampling rate is up to 50GSa/s.

Real Time Sampling: The scope has the highest real-time sampling rate up to 1GSa/s.

Interpolation (Sinx/x) Application Example

Operation steps:

1. Press **【Scope】** and choose **Acquire** to enter acquiring system.
2. Press **【F4】** to choose **Ream Time**.
3. Press **【F3】** to choose **Sinx/x**.

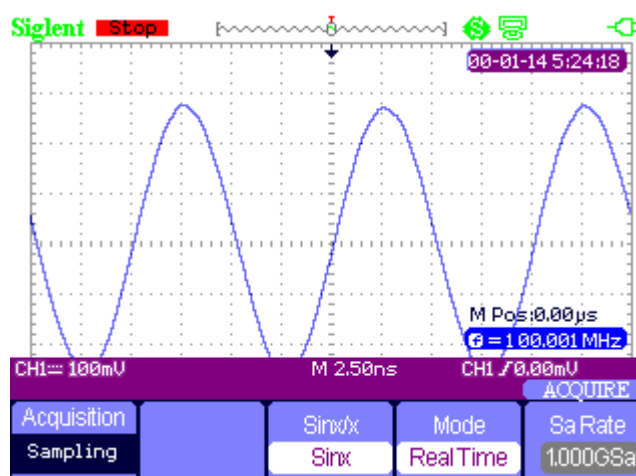

Figure 2-9 Sinx Interpolation

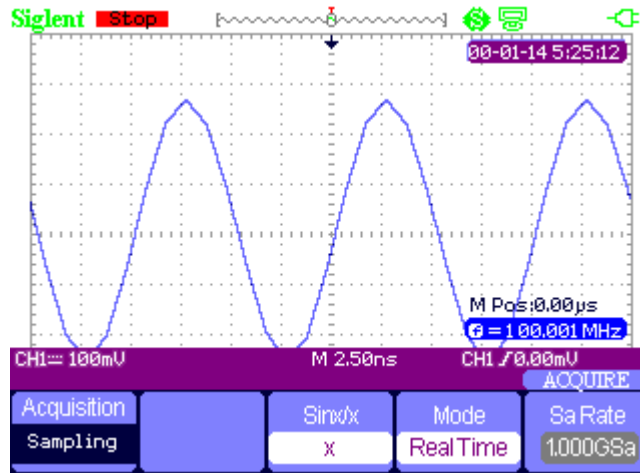

Figure 2-10 X Interpolation

Display System

Press **【Scope】** and choose **Display** to enter display system. See Figure 2-6.



Figure 2-11 Display Menu 1



Table 2-6 Display System Function Menu

Option	Setting	Introduction
Type	Vectors	Vectors fill the space between adjacent sample points in the display.
	Dots	Dots: display sample points directly.
Persist	Off 1 sec 2 sec 5 sec Infinite	Sets the length of time each displayed sample point remains displayed.
Intensity	↻<Intensity>	Set waveform intensity.
Brightness	↻<Brightness>	Set grid brightness.
Next Page	Page 1/2	Enter the second page of DISPLAY menu.



Figure 2-12 Display Menu 2

Table 2-7 Display system function menu 2:

Option	Setting	Introduction
Format	YT	YT format displays the vertical voltage in relation to time (horizontal scale).
	XY	XY format displays a dot each time a sample is acquired on channel 1 and channel 2.
Screen	Normal	Set to normal mode.
	Inverted	Set to invert color display mode.
Grid		Display grids and axes on the screen.
		Turn off the grids and axes.
Menu Display	2sec, 5sec, 10sec, 20sec, Infinite	Set display time of menu on the screen.
Next Page	Page 2/2	Return to the first page of DISPLAY menu.

XY Waveform Application Example

Observe XY waveform, operation steps:

1. Input 2 sine signals to the channels with the same frequency, range and phase 90 degree difference, press the button **【Auto】**.
2. Press **【Scope】** and choose **Display** to enter the display system.
3. Press **【Next Page】** to enter the second page of DISPLAY menu.
4. Press **【F1】** to choose XY mode.
5. Adjust the vertical range of CH 1 and CH 2 to obtain the best XY waveform.

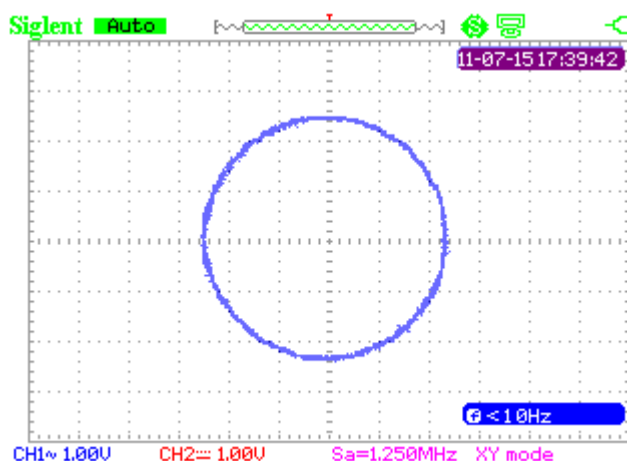

Figure 2-13 XY Waveform

Math Waveform

Press **【Scope】** and choose **Math** to enter the math waveform function menu.



Figure 2-14 MATH Menu

Table 2-8 Math Menu Function

Option	Setting	Instruction
Operation	+	CH1+CH2
	-	CH1-CH2、CH2-CH1
	*	CH1*CH2
	/	CH1/CH2、CH2/CH1
	FFT	Fast Fourier Transform.
Invert	On	Invert the waveform.
	Off	Turn off the invert function
Next Page	Page1/2	Enter the second page of MATH menu.



Figure 2-15 MATH Function Menu

Table 2-9 Addition operation

Option	Setting	Instruction
		Use arrow keys to move the waveform upright.
		Use arrow keys to adjust the scale of math waveform.
Waveform Math Switch	On	Turn on the math waveform..
	Off	Unique key turn off the math waveform.
Next page	Page2/2	Return to the first menu off math waveform.

Waveform Math Application Example

Operation steps of adding two waveforms:

1. Input two signals to the channels and press **【Auto】** .
2. Press **【Scope】** and choose **Math** to enter waveform operation.
3. Press **【F1】** to choose “+” operation.
4. Press **【F5】** to enter the second page of waveform operation menu.
5. Use and functions keys and the arrow keys to change the parameter to display the best waveform.
6. Press **【F4】** to exit the math waveform operation.

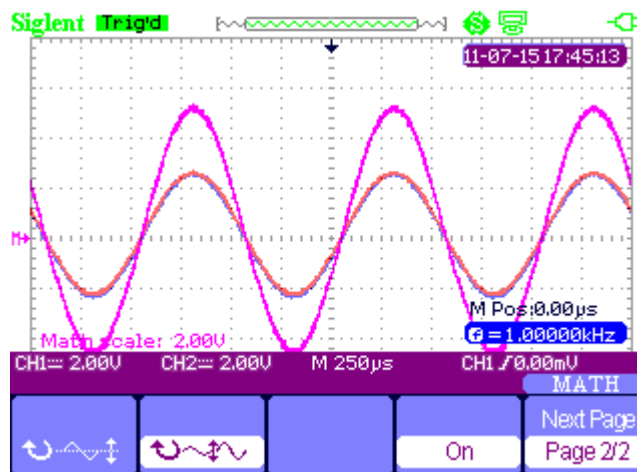

Figure 2-16 Result of Two Waveforms Add

About FFT operation

Using FFT math operation can translate time field signal to frequency field signal.



Figure 2-17 FFT Function Menu 1

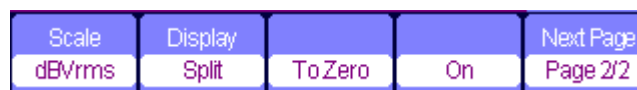

Figure 2-18 FFT Function Menu 2

Table 2-10 FFT Window Function

Window	Characteristic	Advantage content
Rectangular	The best frequency resolution but the worst magnitude resolution. It is essentially the same as no window.	Symmetric transients or bursts. Equal-amplitude sine waves with fixed frequencies. Broadband random noise with a relatively slowly varying spectrum.
Hanning	Better frequency, poorer magnitude accuracy than rectangular	Sine, periodic, and narrow-band random noise.
Hamming	Hamming has a slightly better frequency resolution than Hanning.	Transients or bursts pulse. The ranges of the signals have great difference from before to after.
Blackman	Best magnitude resolution but worst frequency resolution.	Single frequency waveforms, to find higher order harmonics.

FFT Zoom: zoom in FFT waveform vertically by 1X, 2X, 5X and 10X.

Scale: choose **dBVrms** or **Vrms** as a measure unit.

Display: **Spilt** or **Full Screen** FFT waveform display mode.

FFT Waveform Operation Application Example

Operation steps:

1. Input a signal to **CH1** and press **【Auto】** .
2. Press **【Scope】** and choose **Math** to enter waveform operation.
3. Press **【F1】** to choose **FFT**.
4. Press **【F5】** to enter the second page of the menu and adjust the setups.
5. Adjust the channel vertical scale and complete FFT waveform’s vertical position and vertical scale settings.
6. Press **【F5】** to exit waveform operation.

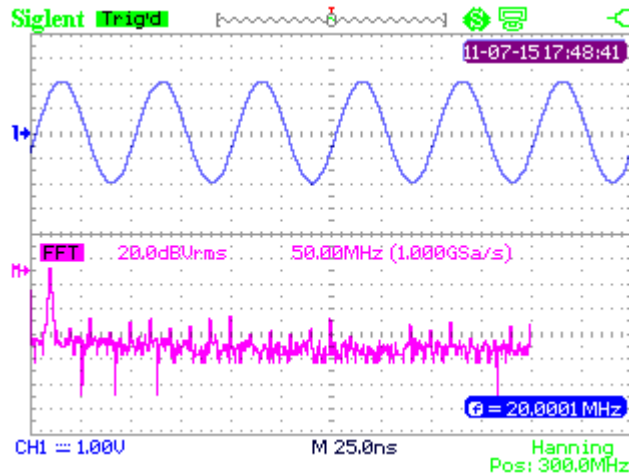

Figure 2-19 FFT Waveform

Horizontal System

Press **【Scope】** and then choose **Horizontal** to enter the horizontal function menu.



Figure 2-20 Horizontal System Menu

Delay scan: zoom in the waveform being chosen.

Memory depth: normal memory and long memory.

Delay Scan Application Example

Operation steps:

1. Input a waveform to **CH1** or **CH2**.
2. Adjust time base to display the best waveform.
3. Press **【Scope】** and then choose **Horizontal** to enter horizontal system.
4. Press **【F1】** to turn on delay scan.
5. Change time base and choose a window waveform to zoom in and analyze.
6. Press **【F1】** to turn off delay scan.

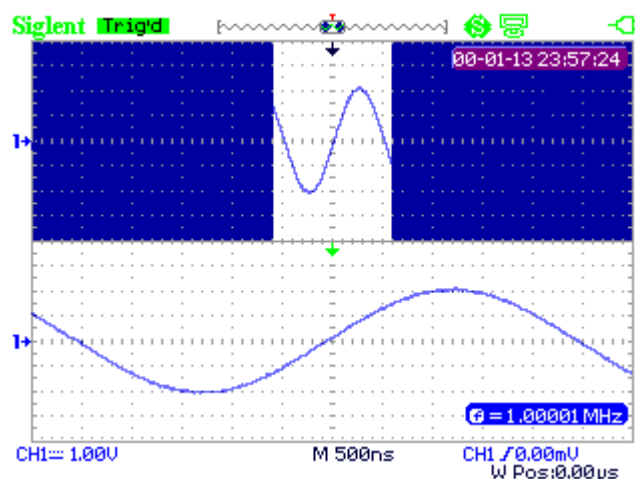

Figure 2-21 Delay Scan Waveform

Normal Memory and Long Memory under Real Time Sample Application Example

Operations steps:

1. Input a sine signal with 100M bandwidth and 4V Vpp to CH1 or CH2, adjust time base to 50nS. The common storage sampling rate will be 1GSa/s while the long storage is 500MSa/s at this time.
2. Press **【Run/Stop】** respectively at common storage and long storage.
3. Change time base to let the whole waveform display on the screen.
4. Count memory depth. Sampling Points=Sampling Rate *Sampling Time

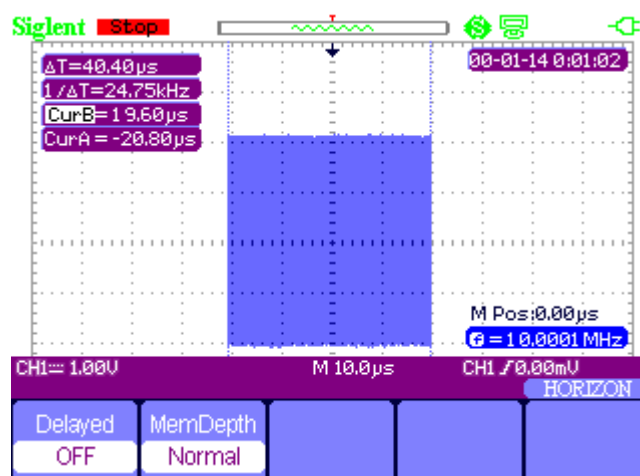

Figure 2-22 Normal Memory

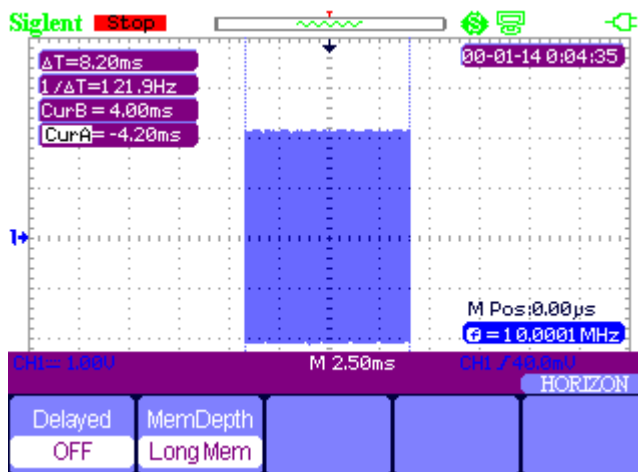

Figure 2-23 Long Memory

Reference waveform

Press **【Scope】** and choose **Ref** to enter the reference waveform function menu.



Figure 2-24 Reference waveform Menu

Table 2-11 REF Waveform Function Menu

Function	Setting	Instruction
Signal	CH1/CH2	Choose the waveform to be saved.
Ref A/Ref B		Choose to save or recall the reference position of the waveform..
Save		Save the source waveform to the pointed reference position.
Ref A/Ref B	On	Display the reference waveform on the screen.
	Off	Clean the reference waveform on the screen.

Reference Waveform Application Example

Operation steps:

1. Input a waveform to **CH1** or **CH2**.
2. Adjust time base to display the best waveform.
3. Press **【Scope】** and choose **Ref** to enter horizontal system.
4. Choose the reference waveform need to save and press **【F4】** to save.
5. Press **【F5】** to show the reference waveform.
6. Press **【F5】** to exit the reference waveform.

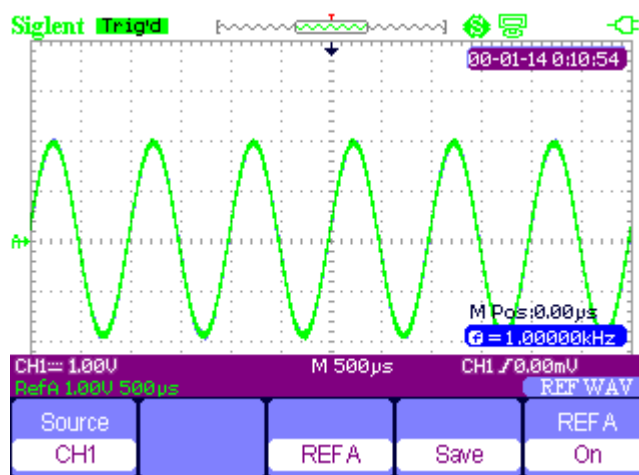

Figure 2-25 Reference Waveform

Cursor and Measure System

Cursor measure

Press **【Cursor/Measure】** once to enter the cursor measure system.

There are three modes of measure: manual, track, automatic.

Manual mode: horizontal or vertical cursors appear in couple and we use them to measure voltage or time parameters. The space between two cursors can be adjusted.

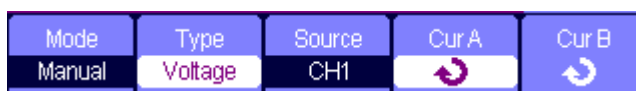

Figure 2-26 Manual Cursor Measurement

Table 2-12 Manual Mode Function Menu

Option	Setting	Instruction
Cursor Mode	Manual	In this menu, set the manual cursor measure.
Type	Voltage Time	Use cursors to measure voltage parameters. Use cursors to measure time parameters.
Source	CH1、CH2 MATH REFAREFB	Choose the signal to be measured by cursors.
Cur A ↻		Use arrow keys to adjust t position of cursor A.
Cur B ↻		Use arrow keys to adjust t position of cursor B.

Track mode: In this mode, the screen displays two cross cursors. The cross cursor sets the position on the waveform automatically. You could adjust cursor's horizontal position on the waveform by turning the arrow keys ". The oscilloscope displays the values on the top of the right screen.

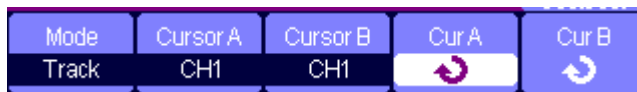

Figure 2-27 Cursor Trace Menu

Table 2-13 Trace Mode Function Menu

Option	Setting	Instruction
Cursor Mode	Track	In this mode, set track cursor measure.
Cursor A	CH1、CH2 NONE	Set the input signal channel that the Cursor A will measure.
Cursor B	CH1、CH2 NONE	Set the input signal channel that the Cursor B will measure.
Cur A ↻		Use arrow keys to adjust the position of cursor A.
Cur B ↻		Use arrow keys to adjust the position of cursor B.

Track Mode Application Example

Operation steps:

1. Press **【Cursor/Measure】** once to enter cursor system.
2. Press **【F1】** to choose **Track** mode.
3. Adjust cursor A and cursor B to trace waveform with arrow keys ,

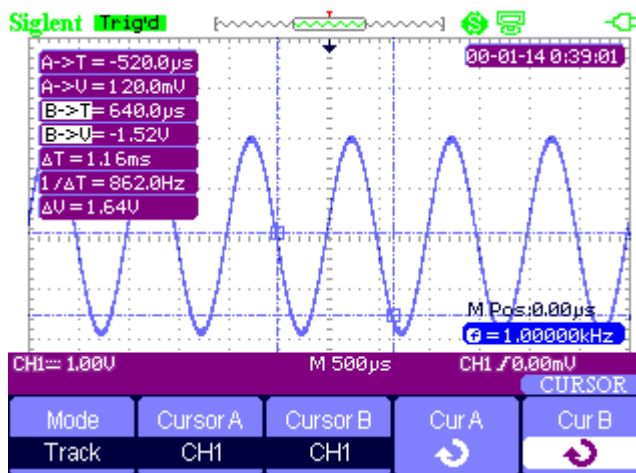

Figure 2-28 Cursor Trace Menu

Automatic measure mode: This mode will take effect with automatic measurements. The instruments will display cursors while measuring parameters automatically. These cursors demonstrate the physical meanings of these measurements.

Automatic Measure Application Example

Operation steps:

1. Press **【Cursor/Measure】** once to enter cursor system.
2. Press **【F1】** to choose **Auto** mode.
3. Press **【Cursor/Measure】** again and choose parameter types to be measured.

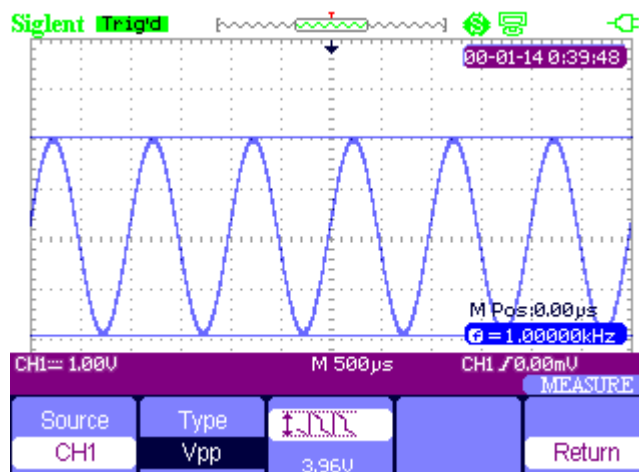

Figure 2-29 Auto Measure

Parameter Measure

Press **【Cursor/Measure】** twice and any key of **F1 ~ F5** to enter parameter measurement system..



Figure 2-30 Parameter Measure Function Menu

Table 2-14 Parameter Measure Function

Option	Instruction
Voltage	Press this button to enter the Voltage measure menu.
Time	Press this button to enter the Time measure menu.
Delay	Press this button to enter the Delay measure menu.
All Mea	Press this button to enter the All Measurement menu.
Return	Return to the home page of MEASURE menu.

Voltage parameter measure



Figure 2-31 Parameter Measure Function Menu

Table 2-15 Voltage Measure Function

Option	Setting	Instruction
Source	CH1,CH2	Select input signal source for voltage measure.
Type	Vpp, Vmax, Vmin, Vamp, Vtop, Vbase, Vavg, Mean, Vrms, FOV, FPRE, ROV, RPRE ,	Press F2 or use the arrow keys to select voltage measure parameter.
Icon		Display the corresponding icon and measure value of your selected Voltage measure parameter.
Return		Return to the home page of MEASUREMENT menu.

Time parameter measure



Figure 2-32 Time Measure Function Menu

Table 2-16 Time Measure Function

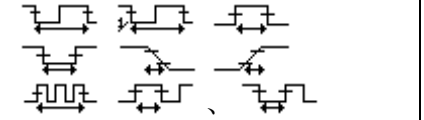
Option	Setting	Instruction
Source	CH1, CH2	Select input signal source for Time measure.
Type	Period, Freq, +Wid, -Wid, Rise Time, Fall Time, BWid, +Dut, -Dut	Press F2 or use the arrow keys to select time measure parameter.
		Display the corresponding icon and measure value of your selected time measure parameter.
Return		Return to the home page of MEASURE menu.

Delay parameter measure



Figure 2-33 Delay Measure Function Menu

Table 2-17 Delay Measure Function

Option	Setting	Instruction
Source	CH1, CH2	Select input signal source for delay measure.
Type	Phase, FRR, FRF, FFR, FFF, LRR, LRF, LFR, LFF	Press the “Type” button or use arrow keys to select delay measure parameter.
		Display the corresponding icon and measure value of your selected Delay measure parameter.
Return		Return to the home page of MEASURE menu.

All parameters measure

































Figure 2-34 All Measure Function Menu

Table 2-18 All Measure Function Menu

Option	Setting	Instruction
Source	CH1, CH2	Select input signal channel.
Voltage	On/Off	Turn on/off the all voltage parameters measure function.
Time	On/Off	Turn on/off the all time parameters measure function.
Delay	On/Off	Turn on/off the all delay parameters measurement function.
Return		Return to the “All Measure main menu”.

Table 2-19 All Measure Function Menu

Measure Type	Introduction
 Vmax	The positive peak voltage.
 Vmin	The negative peak voltage.
 Vpp	The absolute difference between positive peak voltage and negative peak voltage.
 Vtop	The maximal voltage during the measure.
 Vbase	The minimal voltage during the measure.
 Vamp	The difference between the Vtop and the Vbase voltage.
 Vavg	The arithmetic mean over the first cycle of the waveform.

	Mean	The arithmetic mean over the entire waveform.
	Crms	Virtual value: the true Root Mean Square voltage of the first cycle in the waveform.
	Vrms	The true Root Mean Square voltage over the entire waveform.
	ROVShoot	Defined as $(V_{max}-V_{hig})/V_{amp}$ after the waveform rising.
	FOVShoot	Defined as $(V_{min}-V_{low})/V_{amp}$ after the waveform falling.
	RPREshoot	Defined as $(V_{min}-V_{low})/V_{amp}$ before waveform rising.
	FPREshoot	Defined as $(V_{max}-V_{hig})/V_{amp}$ before waveform falling.
	Rise Time	The time between the first voltage level rising from 10% to 90%.
	Fall Time	The time between the first voltage level falling from 90% to 10%
	BWid	The duration of a burst over the entire waveform.
	+ Wid	The time between the first rising edge and the next falling edge of 50% voltage level.
	- Wid	The time between the first falling edge and the next rising edge of 50% voltage level.
	+ Duty	The ratio between the first positive pulse width and the period.
	- Duty	The ratio between the first negative pulse width and the period.
	Phase	The phase difference between two waveforms.
	FRR	The time between the first rising edge of source 1 and the first rising edge of source 2.
	FRF	The time between the first rising edge of source 1 and the first falling edge of source 2.
	FFR	The time between the first falling edge of source 1 and the first rising edge of source 2.
	FFF	The time between the first falling edge of source 1 and the first falling edge of source 2.
	LRR	The time between the first rising edge of source 1 and the last rising edge of source 2.
	LRF	The time between the first rising edge of source 1 and the last falling edge of source 2.
	LFR	The time between the first falling edge of source 1 and the last rising edge of source 2.
	LFF	The time between the first falling edge of source 1 and the last falling edge of source 2.

Parameter Measure Supplication Example

Operation steps:

1. Press **【Cursor/Measure】** twice and any key of **F1~F5** to enter parameter measurement system.
2. Choose any key out of **F1~F5** to choose measure type. For example: **Voltage**.
3. Press **【F2】** to choose measure parameter. For example: **Vpp**.
4. Press **【F5】** to return.

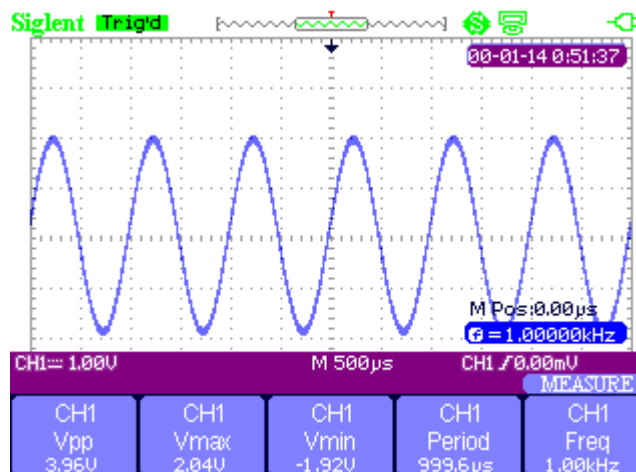

Figure 2-35 All Measure Function Menu

32 types of parameters measure application example

Operation steps:

1. Input two sine signals respectively to CH1 and CH2 with the same frequency, amplitude and different phases,
2. Adjust time base and vertical scale to obtain the best waveform.
3. Press **【Cursor/Measure】** and choose **All**.
4. Turn on **Voltage, Time, Delay** and will display 32 types of parameter measure.

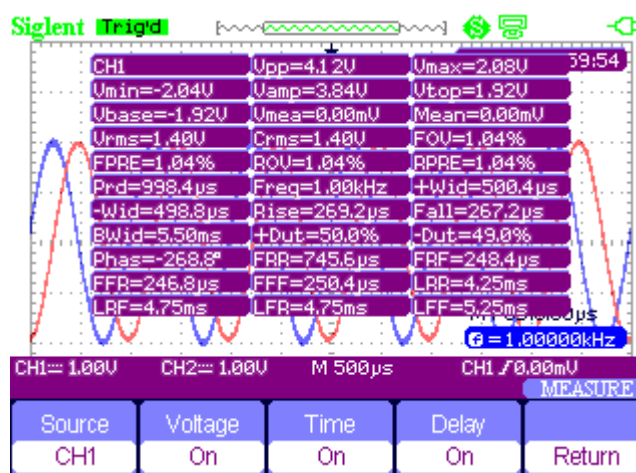

Figure 2-36 32 Types of Parameter Measure

Trigger System

There are 5 kinds of trigger function: edge, pulse, video, slope, alternative.
 Press **【Trigger】** to enter the trigger system.

Edge Trigger



Figure 2-37 Edge Trigger Function Menu

Table 2-20 Edge Trigger Function Menu

Option	Setting	Instruction
Type	Edge	Trigger on the rising or falling edge of the input signal.
Source	CH1, CH2	Set CH1 or CH2 as a trigger source.
Slope		Trigger on rising edge of the trigger signal. Trigger on falling edge of the trigger signal. Trigger on rising and falling edge of the trigger signal.
Mode	Auto	Use this mode to let the acquisition free-run in the absence of a valid trigger; This mode allows an un-triggered, scanning waveform at 100 ms/div or slower time base settings.
	Normal	Use this mode when you want to see the valid trigger waveforms only; the scope will not acquire waveform until satisfied trigger. .
	Single	The setup detects a trigger and acquires waveform, then stop.
Setting		Enter the "Trigger Setup Menu".



Figure 2-38 32 Trigger Setting Function Menu

Table 2-21 Trigger Setting Menu

Option	Setting	Instruction
Coupling	DC	Passes all components of the signal
	AC	Blocks DC components and attenuates signals below 170Hz.
	HF Reject	Attenuates the high-frequency components above 140kHz.
	LF Reject	Blocks the DC component and attenuates the low-frequency components below 7 kHz.
Hold off ↻		Using the arrow keys to adjust hold off time(sec), the hold off value is displayed.
Hold off Reset		Reset hold off time to 100ns.
Return		Return the first page of the menu.

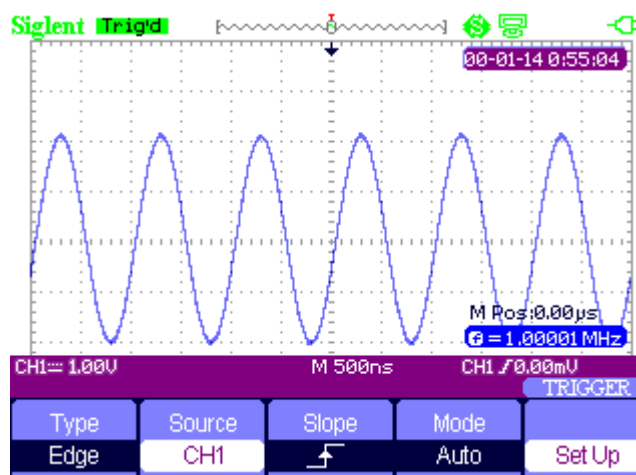

Figure 2-39 Signal Rise Trigger Menu

Pulse Trigger



Figure 2-40 Pulse Trigger Function Menu 1

Table 2-22 Pulse Trigger Function Menu 1

Option	Setting	Instruction
Type	Pulse	Select the pulse to trigger the pulse match the trigger condition.
Source	CH1、CH2	Select input signal source.
Condition	(Positive pulse width less than pulse width set) (Positive pulse width larger than pulse width setting) (Positive pulse width equal to pulse width setting) (Negative pulse width less than pulse width setting) (Negative pulse width larger than pulse width setting) (Negative pulse width equal to pulse width setting)	Compare the trigger conditions of pulse. It triggers as soon as matching the conditions.
Set Width	20.0ns~10.0s	Selecting this option can turn the arrow keys to set up the pulse width.
Next Page	Page 1/2	Enter the second page of the menu.



Figure 2-41 Pulse Trigger Function Menu 2

Table 2-23 Pulse Trigger Function Menu 2

Option	Setting	Instruction
Type	Pulse	Select the pulse to trigger the pulse match the trigger condition.
Mode	Auto Normal Single	Select the type of triggering; Normal mode is best for most Pulse Width trigger applications.
Setup		Enter the “Trigger setup menu”.
Next Page	Page 2/2	Return to the first page of the menu.

Pulse Trigger Application Example

Operations steps:

1. Input a pulse signal.
2. Press **【Trigger】** to enter trigger menu.
3. Press **【F1】** to choose **pulse** trigger.
4. Press **【F3】** to set pulse trigger conditions.
5. Press **【F4】** and use arrow keys to set pulse width.
6. Move trigger level line with the up and down arrow keys. It will trigger as soon as it meets the trigger conditions.

Notes:

We can't adjust trigger level line under the **SetWidth** menu as we use the up and down arrow keys to set both the pulse width and trigger level line. If you want to adjust the trigger level, please make sure that you have exited the **SetWidth** menu.

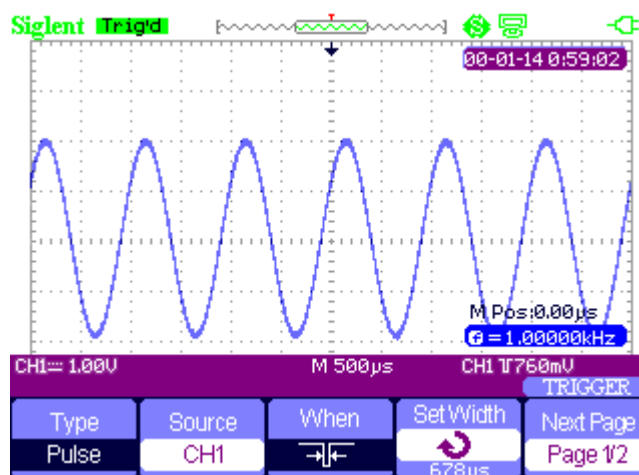

Figure 2-42 Pulse Trigger

Video Trigger



Figure 2-43 Video Trigger Menu 1

Table 2-24 Pulse Trigger Function Menu 2

Option	Setting	Instruction
Type	Video	When you select the video type, put the couple set to the AC, then you could trigger the NTSC, PAL and SECAM video signal.
Source	CH1、 CH2	Select the input source to be the trigger signal.
Polarity	⌋ (Normal)	Normal triggers on the negative edge of the sync pulse.
	⌋ (Inverted)	Inverted triggers on the positive edge of the sync pulse.
Sync	All Lines Line Num Odd Field Even Field	Select appropriate video sync.
Next Page	Page 1/2	Enter the second page of “Video trigger menu”.



Figure 2-44 Video Trigger Menu 2

Table 2-25 Pulse Trigger Function Menu 2

Option	Setting	Instruction
Type	Video	When you select the video type, put the couple set to the AC, then you could trigger the NTSC, PAL and SECAM video signal.
Standard	NTSC, PAL/SECAM	Select the video standard for sync and line number count.
Mode	Auto	Use this mode to let the acquisition free-run in the absence of a valid trigger; This mode allows an un-triggered, scanning waveform at 100 ms/div or slower time base settings.
	Normal	Use this mode when you want to see only valid triggered waveforms; when you use this mode, the oscilloscope does not display a waveform until after the first trigger.
	Single	when you want the oscilloscope to acquire a single waveform, press the “SINGLE ”button.
Set up		Enter the “Trigger setup menu”.
Next Page	Page 2/2	Return the first page of “Video Trigger menu”.

Video Trigger Application Example

Operation steps:

1. Input a video signal.
2. Press **【Trigger】** to enter trigger menu.
3. Press **【F1】** to choose **Video**.
4. Press **【F5】** to enter the second page of video trigger menu.
5. Press **【F2】** to set the video standard **PAL/SECAM** or **NTSC** meeting with the input signal.
6. Press **【F5】** to return to the first page of video trigger menu.
7. press **【F4】** to choose the type of **Sync**. If you choose Line Number, use the up and down arrow keys to set the number of line.
8. Move trigger level line with the up and down arrow keys to set the trigger position.

Notes:

We can't adjust trigger level line under the **Line Number** menu as we use the up and down arrow keys to set both the pulse width and trigger level line. If you want to adjust the trigger lever, please make sure that you have exited the **Line Number** menu.

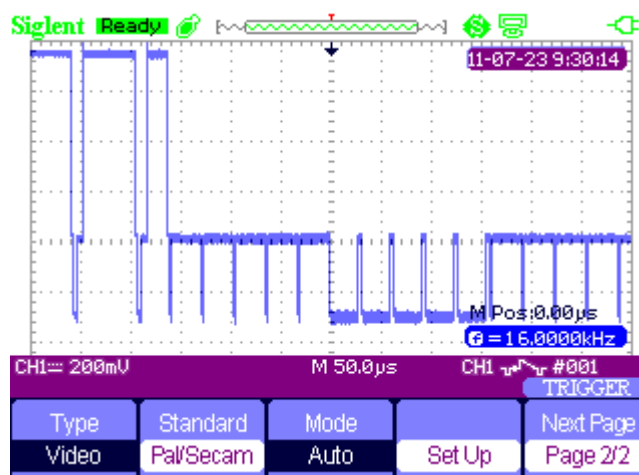

Figure 2-45 Video Trigger

Slope trigger

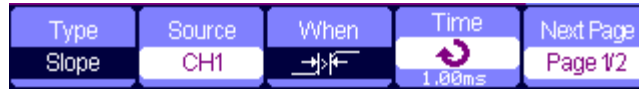

Figure 2-46 Slope Trigger 1

Table 2-26 Slope Trigger Function Menu 1

Option	Setting	Instruction
Type	Slope	Trigger on positive slope of negative slope according to setup time of the oscilloscope.
Source	CH1、CH2	Select trigger source.
Condition		Select trigger conditions.
Time	 〈Set time〉	Use the arrow keys to set slope time. Time setup range is 20ns-10s.
Next Page	Page 1/2	Enter the second page of the slope trigger menu.

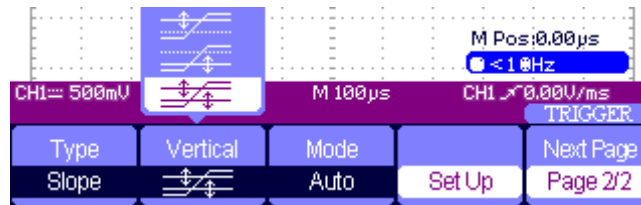

Figure 2-47 Slope Trigger 2

Table 2-27 Slope Trigger Function Menu 1

Option	Setting	Instruction
Type	Slope	Trigger on positive slope of negative slope according to setup time of the oscilloscope.
Vertical		Select the trigger level that can be adjusted by “LEVEL” knob. You can adjust “LEVEL A”, “LEVEL B” or adjust them at the same time.
Mode	Auto	Use this mode to let the acquisition

		free-run in the absence of a valid trigger; This mode allows an un-triggered, scanning waveform at 100 ms/div or slower time base settings.
	Normal	Use this mode when you want to see only valid triggered waveforms; when you use this mode, the oscilloscope does not display a waveform until after the first trigger.
	Single	When you want the oscilloscope to acquire a single waveform, press the “SINGLE ” button.
Set up		Enter the “Trigger setup menu”.
Next Page	Page 2/2	Return to the first page of slope trigger.

Alternative trigger

The trigger signal comes from two vertical channels when you use alternative trigger. In this mode, you can observe two irrelative signals at the same time. You can select different trigger types for two vertical signals, and selected types cover edge, pulse, video and slope trigger. Trigger information of two channel signals display on the bottom right of the screen.



Figure 2-48 Alternative Trigger Menu

Table 2-28 Slope Trigger Function Menu 2

Option	Setting	Instruction
Type	Alternative	The trigger signal comes from two vertical channels when you use alternative trigger. In this mode, you can observe two irrelative signals at the same time.
Source	CHX CHY	Set trigger type information for CHX signal Set trigger type information for CHY signal
Mode	Edge	Set trigger type of the vertical channel signal to Edge
Slope	↗ ↘ ↕	Triggering on rising edge. Triggering on falling edge. Triggering on rising edge and falling edge.
Set up		Enter the “Trigger setup menu”.

Save and Recall System

SHS1000 can save 2 groups of reference waveforms, 20 groups of setups and 10 groups of waveforms in its internal memory. There is an USB Host interface in the front panel of the SHS1000 and you can save setup data, waveform data, waveform interface image, CSV file to an USB flash drive. The postfix of setup data is SET while waveform data is DAV. The waveform data can be recalled to the current SHS1000 or SHS1000 with the same the model. Figure data and CSV file can't be recalled to the SHS1000, but it can be opened on the computer through correlative software. CSV can be opened by EXCEL software on computer.

Saving Setups

Saving Setups to Device

All setups are stored in nonvolatile memory. When recall the setups, the SHS1000 will be under the setup save mode.

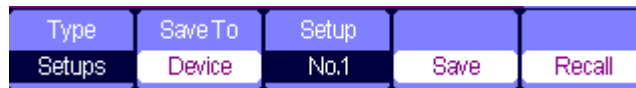

Figure 2-49 Saving Setups to Device Menu

Table 2-29 Saving Setups to Device Function Menu

Option	Setting	Introduction
Type	Setups	Menu for the Save/Recall setting in the SHS1000.
Save to	Device	Save setups to the scope's internal memory.
Setup	No.1 to No.20	Choose the position number to save/recall setups.
Save		Accomplish the operation of saving setups.
Recall		Recall the saved setups.

Saving Setups to USB Flash Drive



Figure 2-50 Saving Setups to USB Flash Drive Menu

Table 2-30 Saving Setups to USB Flash Drive Function Menu

Option	Setting	Instruction
Type	Setup	Used to save/recall the SHS1000's setup menu
Save to	File	Save the setup data of the SHS1000 to USB flash drive.
Save		Enter the waveform save/recall interface.

Saving waveform

Saving waveform to device

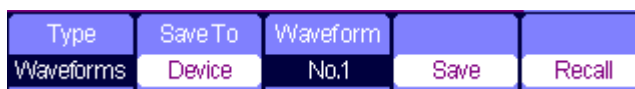

Figure 2-51 Saving Waveform to Device Menu

Table 2-31 Saving Waveform to Device Function Menu

Option	Setup	Introduction
Type	Waveforms	Menu for the Storage/Recall waveforms in the scope.
Save To	Device	Save waveforms to the SHS1000's internal memory..
waveform	No.1 to No.10	Choose the position number to save/recall setups.
Save		Accomplish the storage.
Recall		Recall the storage in the "waveform" operation

Saving waveform to USB Flash Drive



Figure 2-52 Saving Waveform to USB Flash Drive Menu

Table 2-32 Saving Waveform to USB Flash Drive Function Menu

Option	Setup	Introduction
Type	Waveforms	Menu for the Storage/Recall waveforms.
Save to	File	Save waveforms to USB flash drive.
Save		Accomplish the storage.

Saving Picture

Waveform interface image can be saved to USB flash drive, but they can't be recalled. You can view them on correlative computer software.

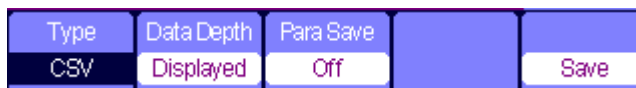

Figure 2-53 Saving Picture Menu

Table 2-33 Saving Picture Function Menu

Option	Setting	Introduction
Type	Picture	Menu for the Storage/Recall waveform interface image.
Print Key	Print Picture	Choose Print Picture option and press Save/Recall for 4 seconds to print the picture while the SHS1000 connects to the printer.
	Save Picture	Choose Save Picture option and press Save/Recall for 4 seconds to save the picture while you insert an USB flash driver to the SHS1000.
Save		Go to the Save/Recall interface.

Saving CSV

**Figure 2-54 Saving CSV Menu****Table 2-34 Saving CSV Function Menu**

Option	Setting	Introduction
Type	CSV	Menu for the Storage CSV file to USB flash drive.
Data Depth	Displayed	Set to store displayed waveform data to CSV file.
	Maximum	Set to store maximum waveform data to CSV file.
Para Save	On/Off	Set whether store parameters to CSV file or not.
Save		Go to the Save/Recall interface.

Recall Factory Setups

Press **Recall** you can recall factory setups.

Table 2-35 Factory Setups Function Menu

Option	Setting	Instruction
Type	Factory	To view the Factory setup.
	Load	Recall the Factory setup.

Save/Recall Waveform to USB Flash Drive Application

Operation steps:

1. Press **【Save/Recall】** and press **【F1】 (Type)** to choose **Waveforms**.
2. Insert USB flash drive to USB host (you will get the message: **USB flash driver connects successfully!**).
3. Press **【F2】 (Save to)** to choose **File**.

4. Press **【F4】 (Save)** to enter save/recall interface.
5. Press **【F1】 (Modify)** to choose **File**.
6. Press **【F2】 (New File)** and input the name of the file according to the prompts to create a new file. Then press **Confirm**.



Figure 2-55 Input the Name of the File

7. File saves successfully.

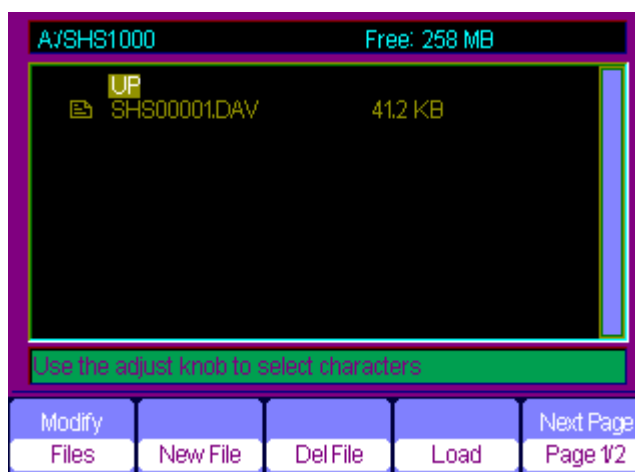

Figure 2-56 File Saves Successfully

Recalling a file:

Choose the file to be recalled and press **Recall** at the memory interface, which you complete the recalling operation.

Notes:

The picture in the SHS1000 with a “BMP” postfix can’t be recalled, but you can open it in computer with relative software.

Utility System

Press **【User】** to enter utility system menu. See figure 2-57.



Figure 2-57 Utility System Menu 1

Table 2-36 Utility System Function Menu 1



Option	Setting	Introduction
System Status		Displays the main information of the SHS1000.
Sound	 	Open the key-press voice. Close the key-press voice.
Counter	On/Off	Turn on/off the frequency counter
Language	Simplified Chinese, English, Traditional Chinese, Arabic, French, German, Russian, Spanish, Portuguese, Japanese Korean, Italian	Select the interface language.
Next Page	Page 1/4	Enter the next page of the menu.

Table 2-37 Utility System Function Menu 2

Option	Setting	Introduction
Do self Cal		Do a self calibration to calibrate the channels.
Do Self Test	Screen Test	Run the screen detect program
	Keyboard Test	Run the keyboard detect program
Print Setup		Enter the print setup menu to set print options.
USB Device	Printer	SHS1000 connects to the printer through USB cable. When you execute print function, please select Printer . At this time the print icon displays on the top of the screen.
	Computer	SHS1000 connects to the computer through USB cable. When you execute EasyScope software, please select Computer . At this time the computer icon displays on the screen.
Next Page	Page 2/4	Enter the third page of the menu.



Figure 2-58 Utility System Menu 2



Figure 2-59 Utility System Print Setup



Figure 2-60 Utility System Menu 3

Table 2-38 Utility System Function Menu 3

Option	Setting	Introduction
Update Firmware		You can update the SHS1000 by using USB flash driver (About two minutes).
Record		Press this button to enter the waveform record menu.
Next Page	Page 3/4	Enter the fourth page of the menu..



Figure 2-61 Utility System Menu 4

Table 2-39 Utility System Function Menu 4

Option	Setting	Introduction
Screen saver	1min 2min 5min 10min 15min 30min 1hour 2hour 5hour Off	Set the time of screen saver
Date/Time		Set the date and time of the SHS1000.
Next Page	Page4/4	Return to the first page of the menu.

Self Calibration

Self Calibration is operated to calibrate the relative data of SHS1000 to decrease the mistake during the measure. If the operating temperature changes by or more than 5° C or the instrument runs more than thirty minutes, you should do the self calibration. When you do the self calibration, you should cut off all the probes and leads. Then press **【User】** button to choose **Do self cal** to show the self calibration menu, and do self calibration program according to the prompts on the screen.

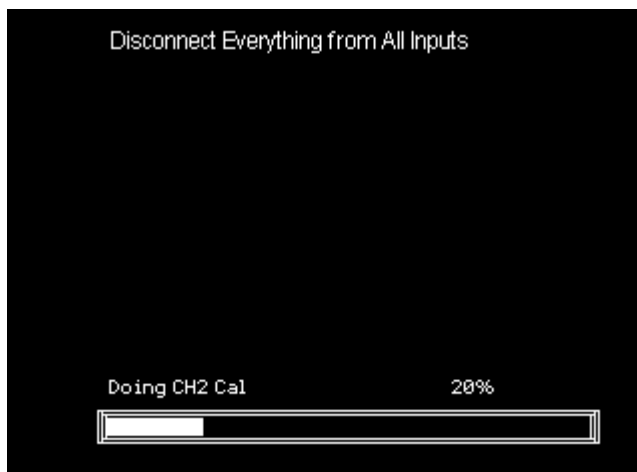

Figure 2-62 Self Calibration

Print Setting

The SHS1000 supports PictBridge compatible printers. You can connect the side USB Device of the SHS1000 to the USB Device of the PictBridge compatible printer through USB cable. After setting the print settings, press **【Save/Recall】** button for 4 seconds to complete the print operation.

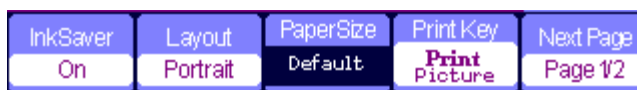

Figure 2-63 Print Setting Menu 1

Table 2-40 Print Setup Function Menu 1

Option	Setting	Introduction
Ink Saver	On Off	Print the screen image on a white background when you select On .
Layout	Portrait/Landscape	The output direction of the printer.
Paper Size	Set the type of the paper.	Displays settings available on your PictBridge compatible printer.

Print Key	Print Picture	Choose Print Picture option and press Save/Recall for 4 seconds to print the picture while the SHS1000 connects to the printer.
	Save Picture	Choose Save Picture option and press Save/Recall for 4 seconds to save the picture while you insert an USB flash driver to the SHS1000.
Next Page	Page 1/2	Enter the second page of the menu.



Figure 2-64 Print Setting Menu 2

Table 2-41 Print Setting Function Menu 2

Option	Setting	Introduction
Image Size	Set the type of the paper.	Set the paper size available to the PictBridge compatible printer.
Paper Type	Default, Plain, Photo, FastPhoto	
Print Quality	Default, Normal, Draft, Fine	
ID Print	Default, On, Off	
Next Page	Page 2/2	Return to the first page of the menu.

Waveform Record

Waveform record: record waveform with a designated interval until reaching the end frame.

When recording CH1 or CH2 waveform, users can set the interval between frames. The recorder can record 2500 frames waveform.



Figure 2-65 Waveform Record Menu

Table 2-42 Waveform Record Menu





Option	Setting	Instruction
Mode	Record	Set recorder function menu.
	Replay	Set replay function menu.
	Off	Turn off waveform record menu.
Source	CH1、CH2	Choose recorder source.
Interval		Set interval of recorder waveform
End Frame		Set the max value of recorder frame.
Operate	 (record)	Start to record
	 (stop)	Stop recording



Figure 2-66 Waveform Play Back Menu 1

Table 2-43 Waveform Play Back Function Menu 1









Option	Setting	Instruction
Mode	Play Back	Set the Play Back function menu.
Operate	 (Run)	Press to start playback playing.
	 (Stop)	Press to stop playing.
Play Mode		Set circular play mode.
		Set single time play mode.
Interval		Set interval between frames.
Next Page	Page 1/2	Enter the second page of the menu.



Figure 2-67 Waveform Play Back Menu 2

Table 2-44 Waveform Play Back Function Menu 2

Option	Setting	Instruction
Start Frame		Set start frame.
Curr_Frame		Select current frame to be played.
End Frame		Set end frame.
Return		Press to return the waveform recorder main menu.
Next Page	Page 2/2	Return to the first page of Play Back function menu.

Waveform Record Application Example

Operation steps:

1. Input a waveform to be recorded.
2. Press **【User】** to enter utility system.
3. Press **【F5】** to enter the third page of the menu and enter waveform recording menu.
4. Press **【F1】** to choose **Record** mode.
5. Use up and down arrow keys to set **【Interval】** and **【End】 Frame**.
6. Press **【F5】** to perform waveform recording.

Waveform Play Back Application Example

Operation steps:

1. Press **【F1】** to choose **Replay** mode.
2. Press **【F5】** to enter the second page of the menu.
3. Set replay **Start Frame, Curr_frame, End Frame** and return to the first page of the menu.
4. Set **【Replay】 Mode, Interval** and press **【F2】** to perform waveform replay.
5. Press **【F1】** to choose **Off** mode to exit waveform record.

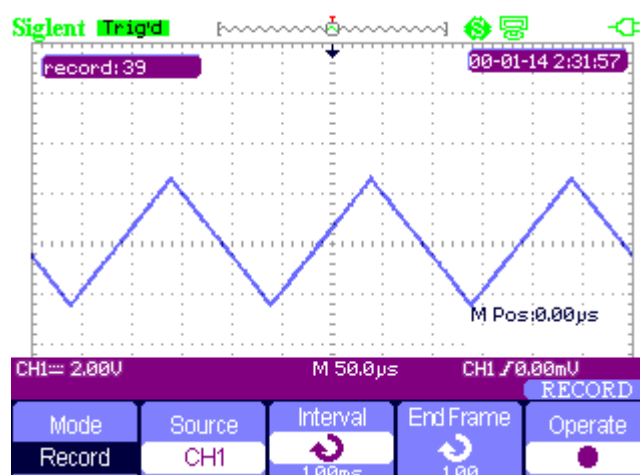

Figure 2-68 Waveform Record

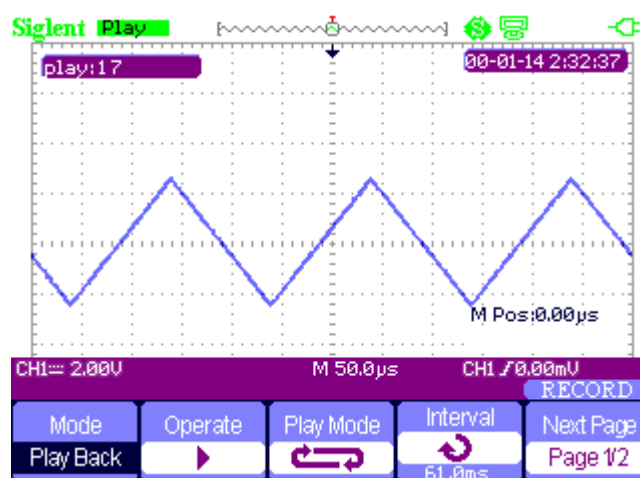

Figure 2-69 Waveform Play Back

Chapter 3 Using the Multimeter

About this Chapter

This chapter provides a step-by-step introduction to the multimeter functions of SHS1000 series Handheld Digital Oscilloscope. The introduction gives basic examples to show how to use the menus and perform basic operations.

The digital multimeter provides the following functions: making DC voltage, AC voltage, resistance, diode, continuity, capacitance, DC current, and AC current measurements.

Notes:

1. You should use the multimeter with correct connections as instructions.
2. The key **【Rub/Stop】** can hold the screen.

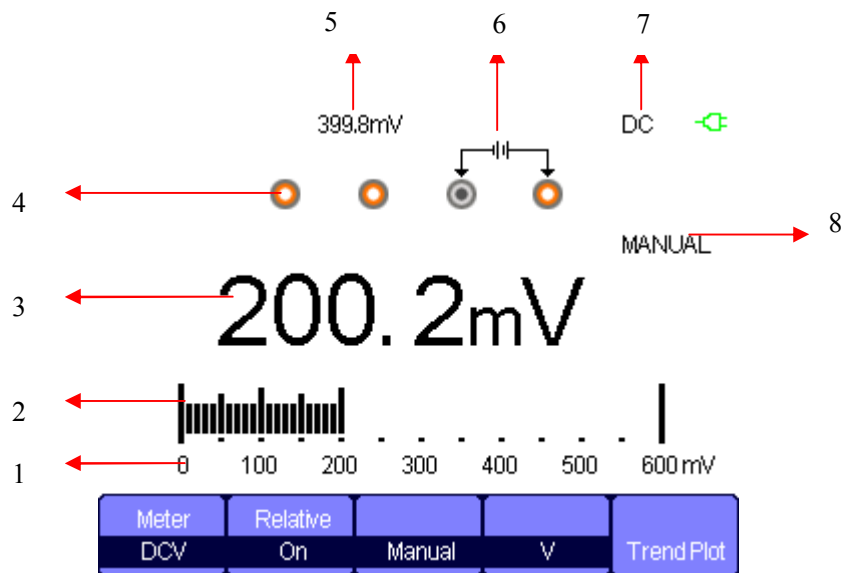

Figure 3-1 Multimeter User Interface

1. the range of the multimeter
2. staffs
3. reading value
4. input ports
5. relative value
6. the indicate of input connection
7. test type
8. operation type

Making DC and AC Voltage Measurement

Table 3-1 DC and AC Function Menu

Option	Setting	Instruction
Relative Value	On	Save the current input value as a reference and record again. Real value equals relative value plus measurement value
	Off	Real value equals measurement value
Mode	Auto	Choose the best measurement scale automatically
	Manual	Choose measurement scale manually
Scale	Auto	Choose the best measurement scale automatically according to the measurement value.
	Manual	Choose measurement scale manually and there will be a warning when over the scale.
Tendency Plot	On	Plot with the measurements according to time

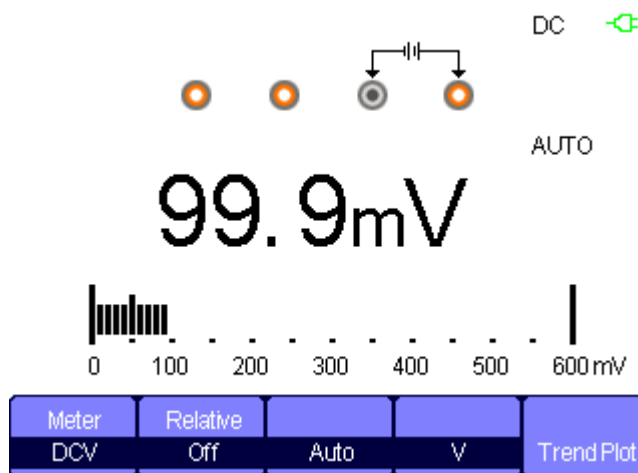

Figure 3-2 DC Voltage Measurement

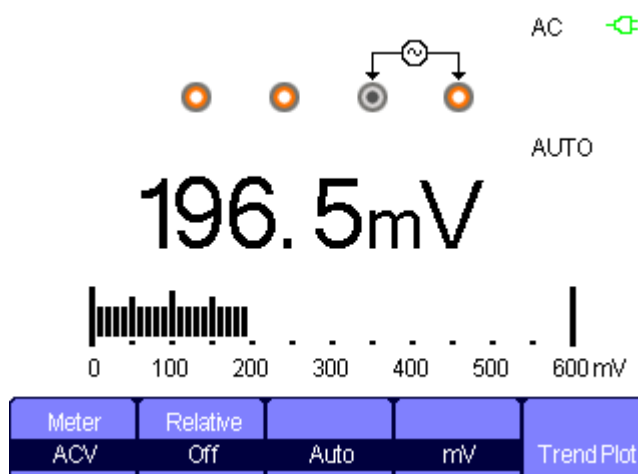

Figure 3-3 AC Voltage Measurement

Operation Steps:

1. Press **【Meter】** to enter multimeter mode, press **【F1】** to choose **DCV, ACV** measurement.
2. Insert the red probe to the **V.Ω.C** banana jack input and the black probe to the **COM**. Connect the other end of probes to the power or load to be measured.
3. Turn on /off the **relative** according to the real demand.
4. Choose **Manual** or **Auto** according to the real demand.
5. Read voltage value.

Making Resistance Measurement

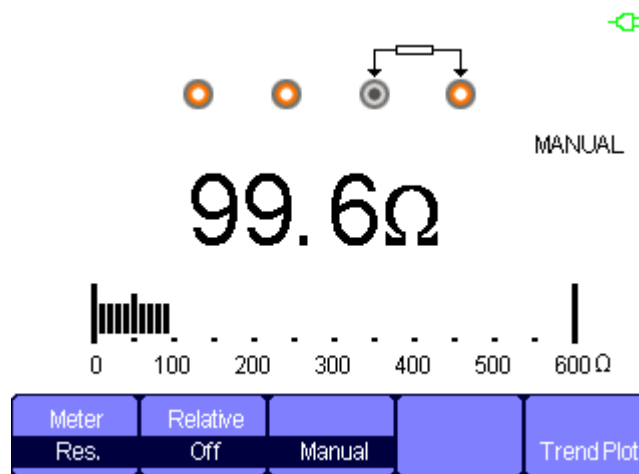

Figure 3-4 Resistance Measurement

Operation steps:

1. Press **【Meter】** to enter multimeter mode, press **【F1】** to choose **Res.** measurement.
2. Insert the red probe to the **V.Ω.C** banana jack input and the black probe to the **COM**. Connect the other end of probes to the power or load to be measured.
3. Turn **on /off** the **relative** according to the real demand.
4. Choose **Manual** or **Auto** according to the real demand.
5. Read resistance value.

Notes:

When measuring resistant, please make sure that the circuit is power off and the capacitance is discharged to avoid damage to the SHS1000.

Making Diode Measurement

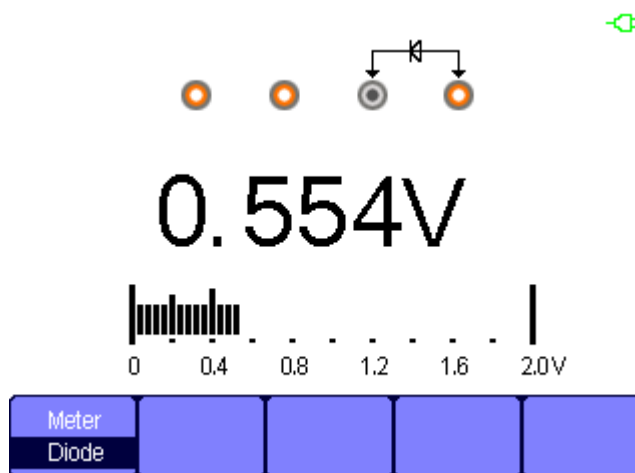

Figure 3-5 Diode Measurement

Operation steps:

1. Press **【Meter】** to enter multimeter mode, press **【F1】** to choose **Diode** measurement.
2. Insert the red probe to the **V.Ω.C** banana jack input and the black probe to the **COM**. Connect the other end of probes to the diode to be measured.
3. Read the value.

Making Continuity Measurement

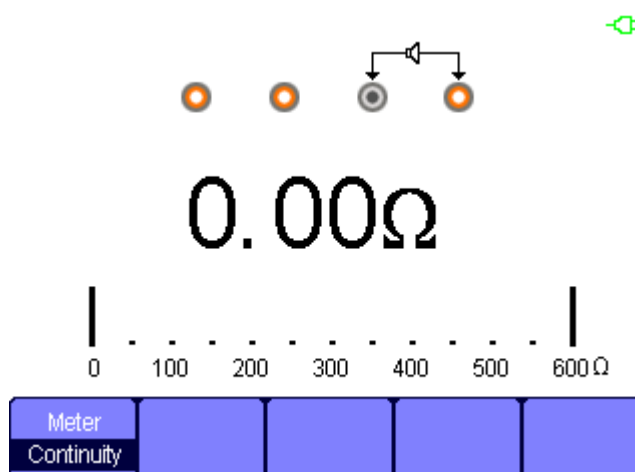
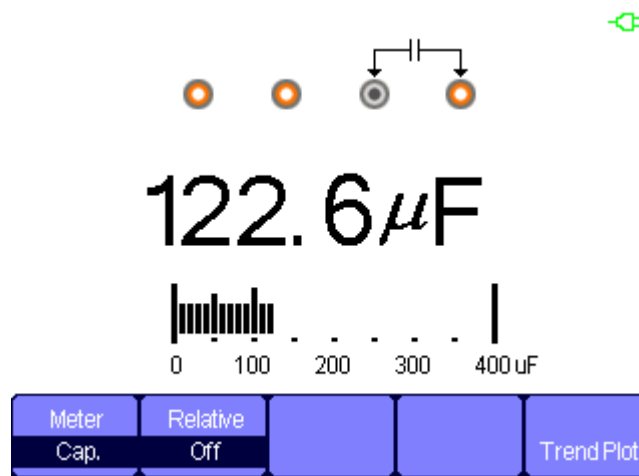

Figure 3-6 Continuity Measurement

Operation steps:

1. Press **【Meter】** to enter multimeter mode, press **【F1】** to choose **Continuity** measurement.
2. Insert the red probe to the **V.Ω.C** banana jack input and the black probe to the **COM**. Connect the other end of probes to the object to be measured.
3. When the measured object is under $50\ \Omega$, the multimeter will alarm and read value.
4. When the measured object is above $50\ \Omega$, the multimeter will not alarm and read value.

Making Capacitance Measurement**Figure 3-7 Capacitance Measurement****Operation steps:**

1. Press **【Meter】** to enter multimeter mode, press **【F1】** to choose **Cap.** measurement.
2. Insert the red probe to the **V.Ω.C** banana jack input and the black probe to the **COM**. Connect the other end of probes to the measured object.
3. Turn **on /off** the **relative** according to the real demand.
4. Read measurement value.

Making DC and AC Current Measurement

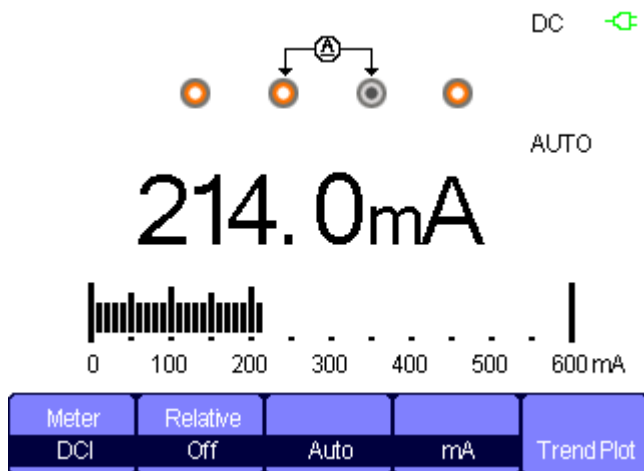

Figure 3-8 DC Current “mA” Measurement

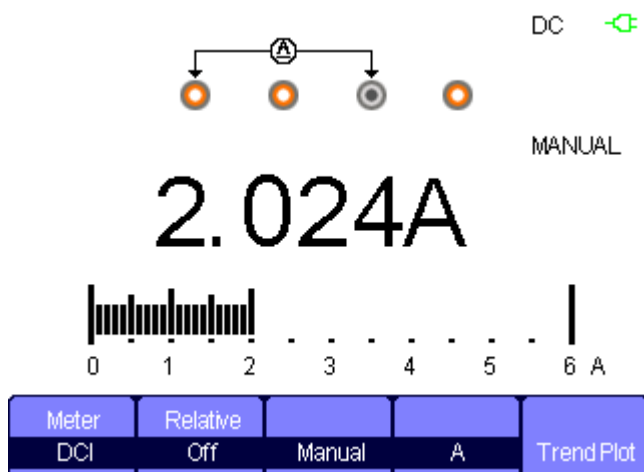

Figure 3-9 DC Current “A” Measurement

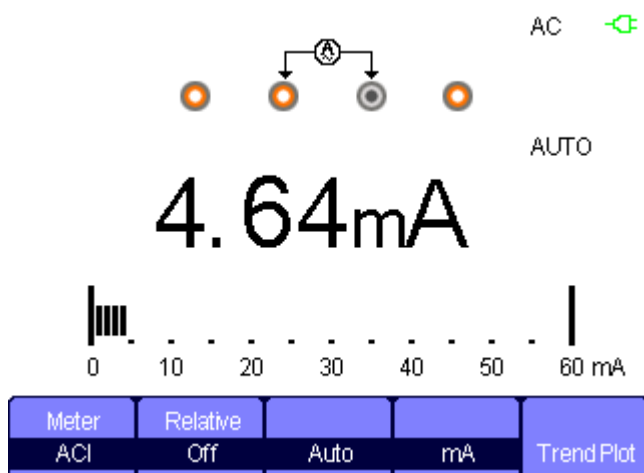

Figure 3-10 AC Current “mA” Measurement

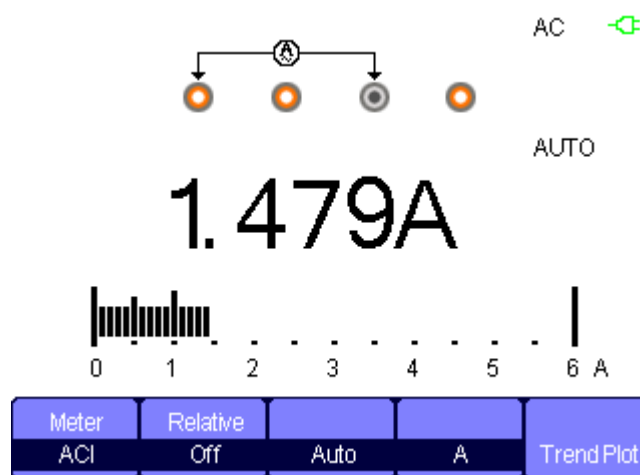

Figure 3-11 AC Current “A” Measurement

Operation steps:

1. Press **【Meter】** to enter multimeter mode, press **【F1】** to choose **DCI/ACI** measure.
2. Insert the red probe to the **A or mA** banana jack input and the black probe to the **COM**. Connect the other end of probes to the power or load to be measured.
3. Turn on /off the **relative** according to the real demand.
4. Choose **Manual** or **Auto** according to the real demand.
5. Read current value.

Chapter 4 Using the Recorder Functions

About this Chapter

This chapter provides a step-by-step introduction to the recorder functions of SHS1000 series Handheld Digital Oscilloscope. The introduction gives basic examples to show how to use the menus and perform basic operations.

The recorder mainly includes the following functions:

Trend Plot: Trend plot is to save the measurements in the memory and then plot a graph of Scope or Meter measurements as a function of time.

Waveform Recorder: Record real time waveform without gap or space. That is to say every time the SHS1000 can save all captured waveform data and then replay them. The maximal recording length of waveform recorder is 7M data points.

Oscilloscope Trend Plot

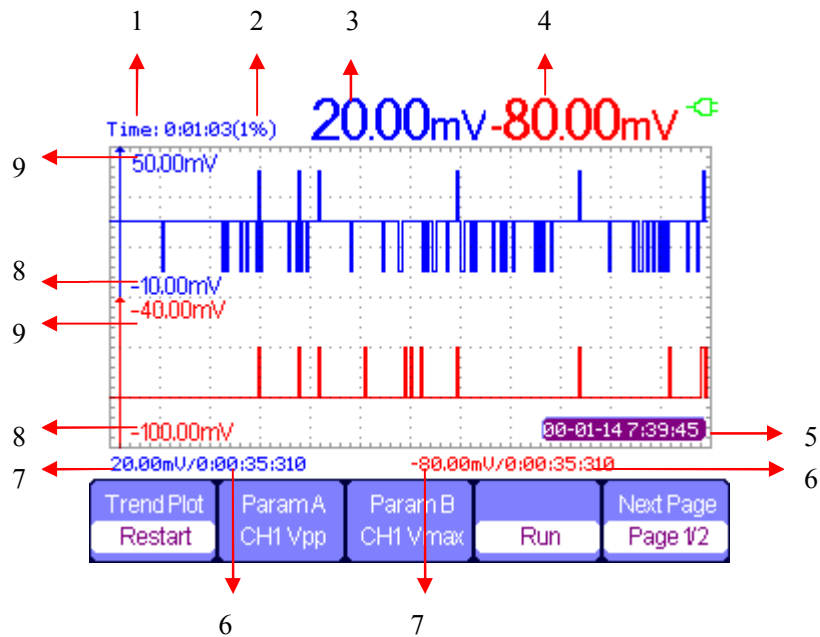

Figure 4-1 Scope trend plot user interface

1. current recorded time
2. the percentage of recorded date take in the whole memory
3. Value of the latest recorded data point A
4. Value of the latest recorded data point B
5. real time
6. sampling time of the cursor point
7. parameter measurement of the cursor point
8. vertical scale
9. vertical scale



Figure 4-2 Scope Trend plot Function Menu 1

Table 4-1 Scope Trend plot Function Menu 1

Option	Setting	Instruction
Trend Plot	Restart	Quit the current data and start to record afresh.
Parameter A/B	Choose the parameter to be measured.	Voltage , time and delay measurement
Run/Stop		Stop or continue recording data
Next Page	Page 1/2	Enter the second page of the menu.



Figure 4-3 Scope Trend plot Function Menu 2

Table 4-2 Scope Trend plot Function Menu 2

Option	Setting	Instruction
Display Mode	Normal	Display the data up to the minute.
	View all	Display all date in a compressing proportion
Manual	Off	Record data automatically
	On	Record data manually. A Record presses a record.
Waveforms		Memory data transfer to exterior storage device
Return		Return to the oscilloscope interface
Next Page	Page 2/2	Return to the first page of the menu.

First choose a measurement in scope or meter mode. You can choose the recorder functions from the waveform recorder main menu. To open the main menu, do the following:

Press **【Recorder】** to open the recorder main menu.



Figure 4-4 Recorder Function Main Menu

Scope Trend Plot Application Example

Operation steps:

Open trend plot function

1. Input a signal to CH1 or CH2.
2. Press **【Recorder】** to enter the recorder main menu.
3. Press **【F1】** to choose **Scope Plot**.
4. Choose measured **parameter A/B** and start recording the trend plot. The scope
5. Press **【F5】** to pause or continue recording data.

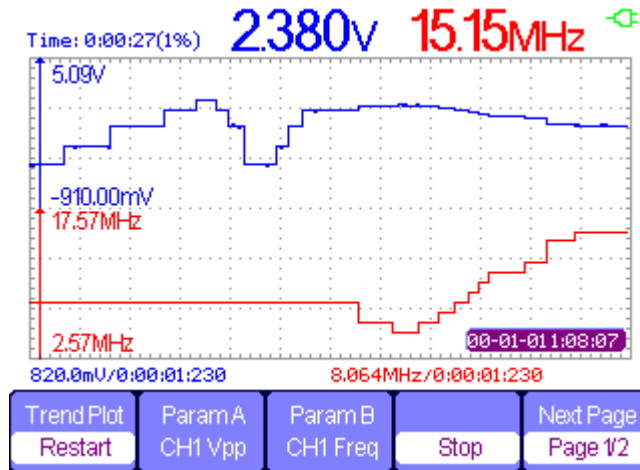

Figure 4-5 Trend Plot record Curve

Display recorded data

6. Press **【F5】** to enter the second page of trend plot menu.
7. Press **【F1】** to choose data display mode.
 - Normal:** the screen displays the data up to the minute.
 - View All:** the screen displays all data in the memory.
8. Zoom function: under full screen mode, press time base to zoom in or zoom out.
9. Data analysis: move cursor, analyzing data over time.

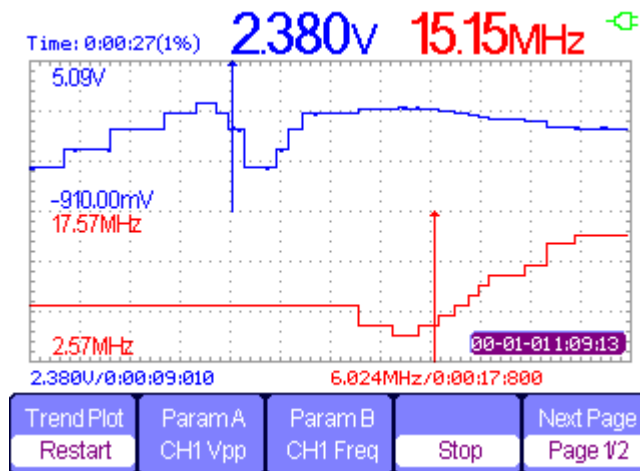

Figure 4-6 Analyzing Trend Plot

10. Save waveform: save the recorded waveform to exterior storage device to make more detailed analysis.
11. Press **Return** to exit trend plot.

Waveform Recorder

Press **【Recorder】** to enter recorder main menu under scan time base, then press **【F2】** to choose Scope recorder.



Figure 4-7 Waveform Recorder Menu

Table 4-3 Waveform Recorder Function Menu

Option	Instruction
Record	Record waveform without gap.
Replay	Replay the recorded waveform.
Option	Setup the parameters of waveform recorder.
return	Exit waveform recorder function.



Figure 4-8 Waveform Recorder Saving Mode Menu

Table 4-4 Waveform Recorder Saving Mode Function Menu

Option	Instruction
Start	Begin to record waveform.(record waveform under 100mS and above scan time base)
replay	Replay the recorded waveform.
Copy	Copy the waveform saved in the memory to the USB flash disk.
Save mode	Choose a place to save record, including memory USB flash disk. USB flash driver saves only under 2.5s/div and above time base.
return	Exit the submenu and return to the waveform recorder main menu.



Figure 4-9 Waveform Recorder Replaying Mode Menu

Table 4-5 Waveform Recorder Replaying Mode Function Menu

Option	Instruction
Stop/Continue	Pause or continue playing waveform automatically, you can change the time base to observe the waveform in the memory.
Restart	Replay the waveform
Previous	Back the waveform and then play.
Next	Speed the playing of the waveform.
Return	Exit the replaying menu.

**Figure 4-10 Waveform Recorder Setting Menu****Table 4-6 Waveform Recorder Setting Menu**

Option	Setting	Instruction
Viewer mode	Full screen	Record and replay channel waveform with full screen
	Split	Record and replay channel waveform with divided screen. The up half of the screen displays CH1 while the down half displays CH2.
Record mode	continuous	Record circularly, when the waveform recorder is full, the after data will cover the pre-data.
	Single	Stop recording data when the waveform recorder memory is full.
Replay mode	By Point	When replaying, the screen waveform updates every dot from left to right.
	By frame	When replaying, the screen waveform updates the whole screen according to the time of sampling every frame data.
return		Exit the recorder setup interface.

Waveform recorder application example**Startup the waveform recorder function:**

1. Under 100mS or above time base.
2. Press **【Recorder】** to open the main menu.
3. Press **【F2】** to choose **scope recorder**.
4. Press **【F3】** to set the waveform recorder. Such as
5. Press **【F5】** to return to the waveform recorder main menu.
6. Press **【F1】** to enter record interface.
7. Press **【F4】** to set storage mode. Interior and USB flash disk storage mode.

- Press **【F1】** to start recording data.

The waveform will not move right and the recorded data saved to memory. The recorded time will be different according to the time base. You can pause or stop at any time.

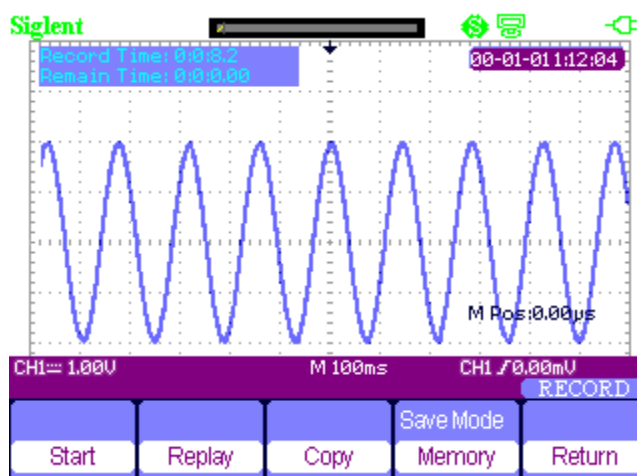

Figure 4-11Waveform Recorder Interface

Waveform replay

- Press **【F2】** to replay waveform.

You can replay the recorded waveform for several times and you can Advance or back off at any time.

- Press **【F5】** to exit the waveform recorder.

Multimeter Trend Plot

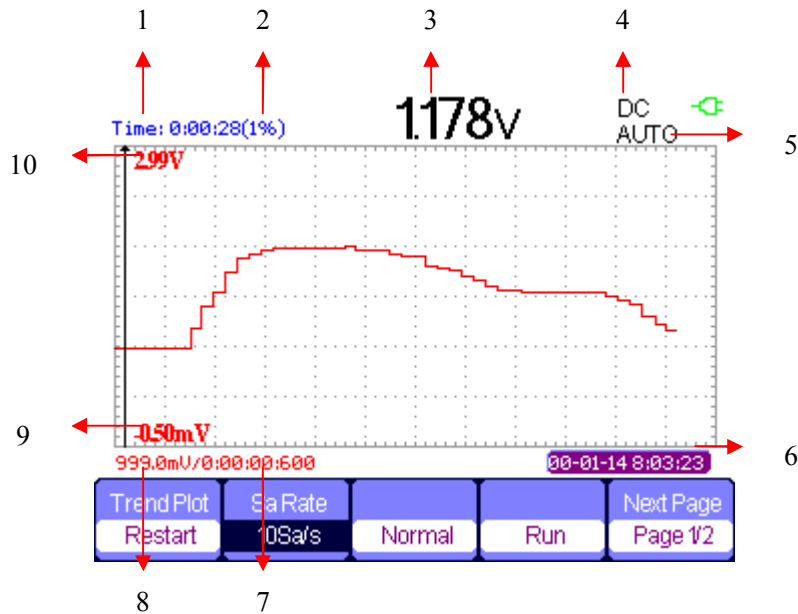

Figure 4-12 Multimeter Trend Plot User Interface

1. current recorded time
2. the percentage of the current data take in the whole memory
3. the parameter value of the recorded data up to the minute
4. DC/AC
5. manual/auto
6. the real time
7. the sample time of the cursor point.
8. the parameter measurement value of the cursor point
9. vertical scale
10. vertical scale



Figure 4-13 Multimeter Trend Plot Menu 1

Table 4-6 Multimeter Trend Plot Function Menu 1

function	setting	Instruction
Restart		Quit the current data and start to record afresh.
Sa Rate	10Sa...0.005Sa	Set sampling rate
Display mode	normal	Display the recorded data up to the minute.
	All view	Display all dots.
Record	Run	Record data automatically

mode	Stop	Stop record data
Next Page	Page 1/2	Enter the second page of the menu.



Figure 4-14 Multimeter Trend Plot Menu 2

Table 4-7 Multimeter Trend Plot Function Menu 2

Function	Setting	Instruction
Waveform storage		Data in the memory transferred to the exterior storage device.
Record manually	Off	Record data automatically
	On	Record data manually. A Record presses a record.
Return		Return to the multimeter function state
Next Page	Page 2/2	Return to the first page.

Multimeter trend plot application example

Start plot function

Operation steps:

1. Input a measured signal correctly. See **chapter 3 Using the Multimeter**.
2. Press **【F5】** to enter Trend Plot at the multimeter main menu.
The SHS1000 will record the measurement value of the input port continuously and plot measurements over time.

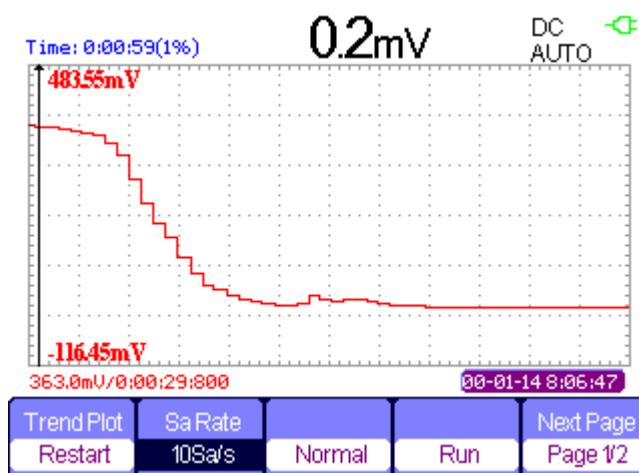

Figure 4-15 Multimeter Trend Plot Recording Curve

3. Press **【F4】** to stop or run recording data.
4. At the second page of the menu you can choose manual or auto mode to record the data.

Display the record data

5. Press **【F3】** to choose data display mode.
 - Normal mode: the screen displays the data up to the minute. The recorded data before saved in the memorizer.
 - Full view mode: the screen display all recorded data in the memorizer.
6. Zoom function: under full screen mode, press time base to zoom in or zoom out.
7. Data analysis: move cursor, analyzing data over time.

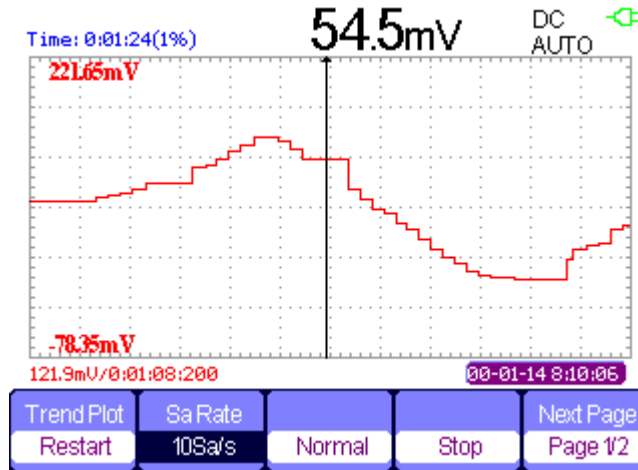

Figure 4-16 Analysis Trend Plot Data

8. Save waveform: save the recorded waveform to exterior storage device to make more detailed analysis.
9. Press **Return** to exit trend plot.

Chapter 5 Prompting and Troubleshooting

About this Chapter

This chapter gives a detailed instruction of every system prompting appears on the screen as well as some basic troubleshooting.

System Prompting Messages Instruction

- ◆ **Trig level at limit!** : Mention you that the trigger level is at a limit when you turn the Trig level knob.
- ◆ **Horizon position at limit!** : Mention you that the horizontal position is at a limit when you turn the horizon position knob.
- ◆ **Volts/Div at limit!** : Mention you that the vertical voltage have already touched the Min 5mV/div or the Max 100V/div.
- ◆ **Volts position at limit!** : The system would display this information when the vertical position is at a limit.
- ◆ **Sec/Div at limit!** : Prompts that the Volts/Div is at full range while turning the vertical scale knob.
- ◆ **Holdoff time at limit!** : Use the arrow keys when holdoff time has been to max or min value, now the system will clew this information.
- ◆ **Function isn't useable!** : Under several special modes, the some functions could not be running.
- ◆ **No signal!** : The system would clew this information when the signal could not match the auto set condition. (Using in the auto set)
- ◆ **Adjust at limit!** : You could adjust the pulse width by the arrow keys till the pulse width has reached min20.0ns or max 10.0s.
- ◆ **Location Empty!** : If you have no stored waveforms or setups on some location, the screen will display this information when you press the "Recall" button on this location.
- ◆ **USB Flash Drive Plug In!** : This information will appear when you invert the USB Flash Drive to the USB Host port.
- ◆ **USB Flash Drive Pull Out!** : This information will appear when you pull out the USB Flash Drive.

- ◆ **Store Data Success!** : Save setup data, waveform data or Figure data to the internal of the oscilloscope or USB flash successful.
- ◆ **Ready Data Success!** : Read setup data or waveform data from the internal of the oscilloscope or USB flash successful.
- ◆ **Please set USB Device to printer!** : Press the “S/div” knob will appear this information on the screen when the “Print Key” option is set to “Print Figure” and the “USB Device” option is set to “Computer”.
- ◆ **USB Flash Drive isn’t connected!** : When the “Save To” option is set to “File” or the “Print Key” option is set to “Save Figure” in “Save/Recall” menu , Press the “Save” option button or the “S/div” knob before inverting the USB Flash Drive to the USB Host port will appear this information on the screen.
- ◆ **Record Wave Success!** : This message will appear when you finish recording waveforms.

Troubleshooting

1. **After the Handheld Digital Oscilloscope is powered on, the screen remains dark , please do as following steps:**
 - 1) Check the power cable's connection.
 - 2) Ensure the power switch is turned on.
 - 3) After the inspections above, restart the Handheld Digital Oscilloscope.
 - 4) If the Handheld Digital Oscilloscope is still not used after the checking, please connect with MY company

2. **If there is no signal wave in the screen after gathering the signal, please do as following steps:**
 - 1) Check the probe connecting with the signal cable or not
 - 2) Check the signal cable connecting with the BNC connector or not.
 - 3) Check the probe whether connect with the goods tested or not.
 - 4) Check the tested goods produce the signal or not.
 - 5) Gather the signal again.

3. **The value of the tested voltage is 10 times higher/lower than the real one , please do as following steps:**

Check the attenuation quotient whether match the probe attenuation proportion or not.

4. **Display the wave, but not steady , please do as following steps:**
 - 1) Check the signal source on the trigger interface whether or not matches the signal channel.
 - 2) Check the trigger mode: normal signal should use the "edge" trigger mode. The video signal should use the "Video" Trigger mode. The signal would display steady, only using the matching trigger mode.
 - 3) Attempt to change the " coupling" into "HF Reject" or "LF Reject" display, so that the High/low frequency noise disturb the trigger should be filtrated

5. **Press "RUN/STOP" button, but no display.**

Check the trigger mode on the trigger interface whether or not in the "normal" or "single", and check the trigger level is whether or not over the wave range. If yes, please put the trigger level to the middle position or set the trigger mode to the "Auto" position. In another hand, you could choose the "Auto" button to set up automatically.

6. After the Acquisition is set to Averages or Display Persistence time is set too long, the waveform refreshes slowly.

It is normal in these settings

7. The signal is displayed as ladder like waveform

- 1) This phenomenon is normal. The time base maybe is too slow .you should turn the horizontal SCALE knob to increase horizontal resolution to improve the display.
- 2) Maybe the display Type is set to “Vectors”, You could set it to Dots mode to improve the display.

8. The multimeter measurements aren't correct

- 1) Check that if the range of the SHS1000 matches with the measured item.
- 2) Make sure that if the multimeter is beyond the calibration date. if the measurements and the real values are beyond the relevant precision, please contact with the calibration site warranted by **SIGLENT** company to calibrate the SHS1000 .
- 3) If you can't use the SHS1000 normally all the same, please contact with **SIGLENT** servicing center, we will provide service for you.

9. The other kind of trouble, please contact with SIGLENT servicing center. For more details please see service and support.

Warning: person without warranty by SIGLENT Company shouldn't disconnect the machine for inspection or you will lose the quality guarantee.

Chapter 6 Service and Support

About this Chapter

This chapter covers basic maintain procedures that can be performed by the user. You should have a detailed understanding of the content below to use and maintain you legal rights.

Maintain Summary

Each **SIGLENT** product is warranted to be free from defects in material and workmanship under normal use and service. The warranty period is three years and begins on the data of shipment. This warranty extends only to the original buyer or ender-user c of a SIGLENT authorized reseller. If a product or CRT proves defective within the warranty period, SIGLENT will provide repair or replacement as described in the complete warranty statement.

To arrange for service or obtain a copy of the complete warranty statement, please contact with the nearest SIGLENT sale and service office.

Except this summary or the applicable warranty statement, SIGLENT makes no warranty of any kind of express or implied, including without limitation the implied warranties of merchantability and fitness for a particular purpose. In no event shall SIGLENT be liable for indirect, special or consequential damages.

Contact SIGLENT

SIGLENT TECHNOLOYIES CO., LTD

Address: 3/F , No. 4 BUILDING, 3rd LIUXIAN Rd, ANTONGDA INDUSTRY GARDEN,
BAO'AN DISTRICT, SHENZHEN,518101, CHINA

Tel: 0086 755 36615186

E-mail: sales@siglent.com

<http://www.siglent.com>

Safety

Designed for measurements on 1000 V Category II Installations, 600 V Category III Installations, Pollution Degree 2, per:

- ANSI/ISA S82.01-1994
- EN61010-1(1993)(IEC1010-1)
- CAN/CSA-C22.2 NO.1010.1-92
- UL3111-1

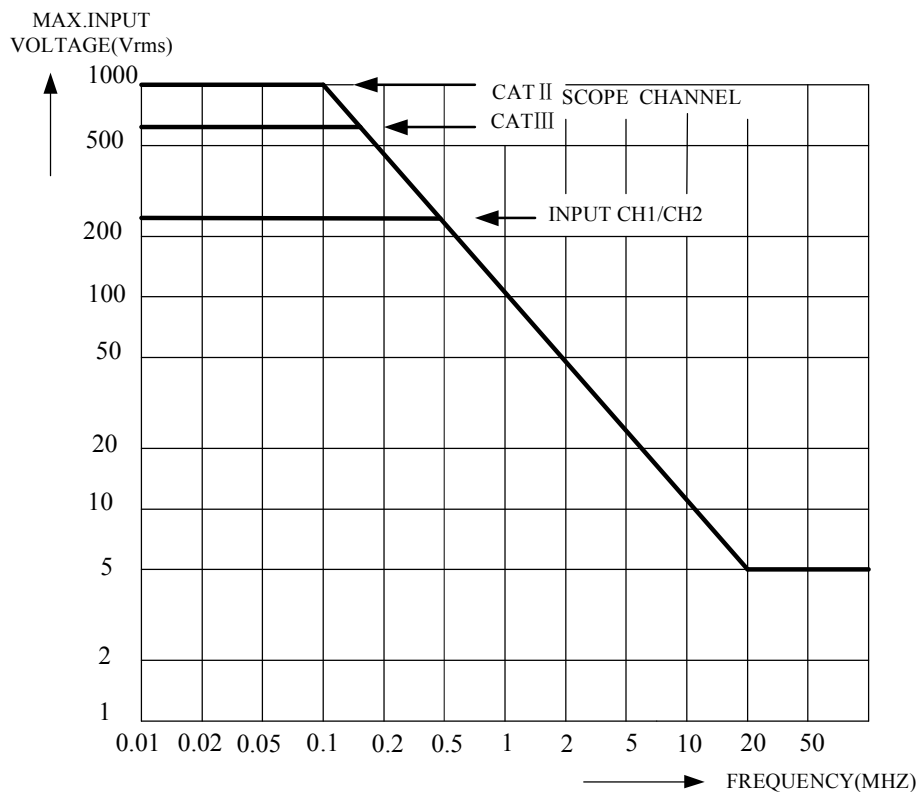

Maximal Input Voltage VS Frequency

Notes:

Overvoltage Category III refers to distribution level and fixed installation circuit inside a building, overvoltage Category II refers to local level, which is applicable for appliances and portable equipment.

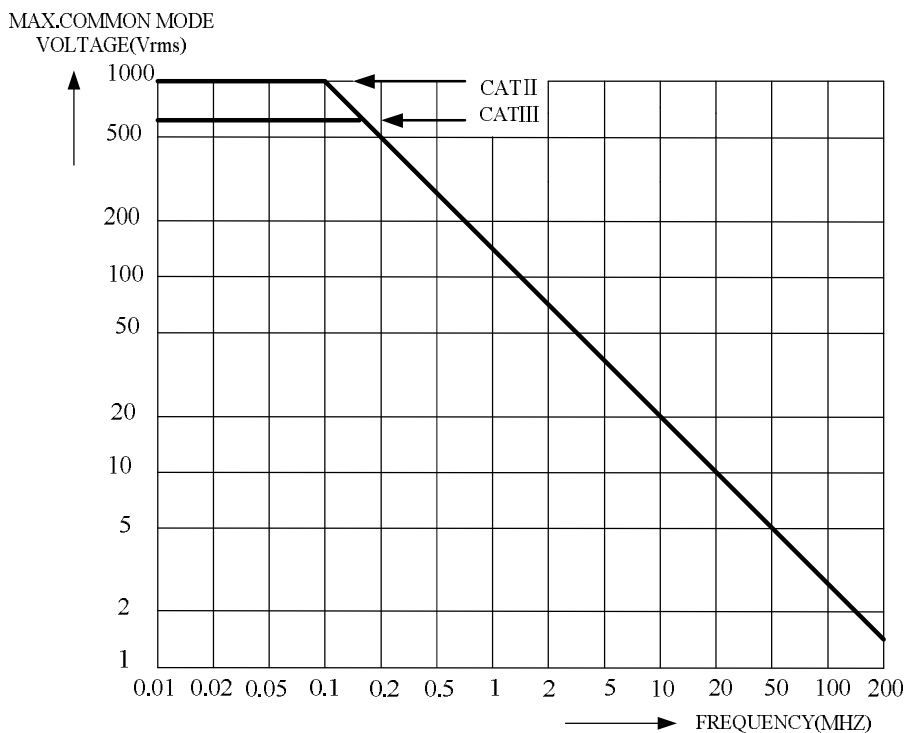

Safe Handling: Maximal Input Voltage Between Scope Reference and Between Scope Reference and Multimeter Reference

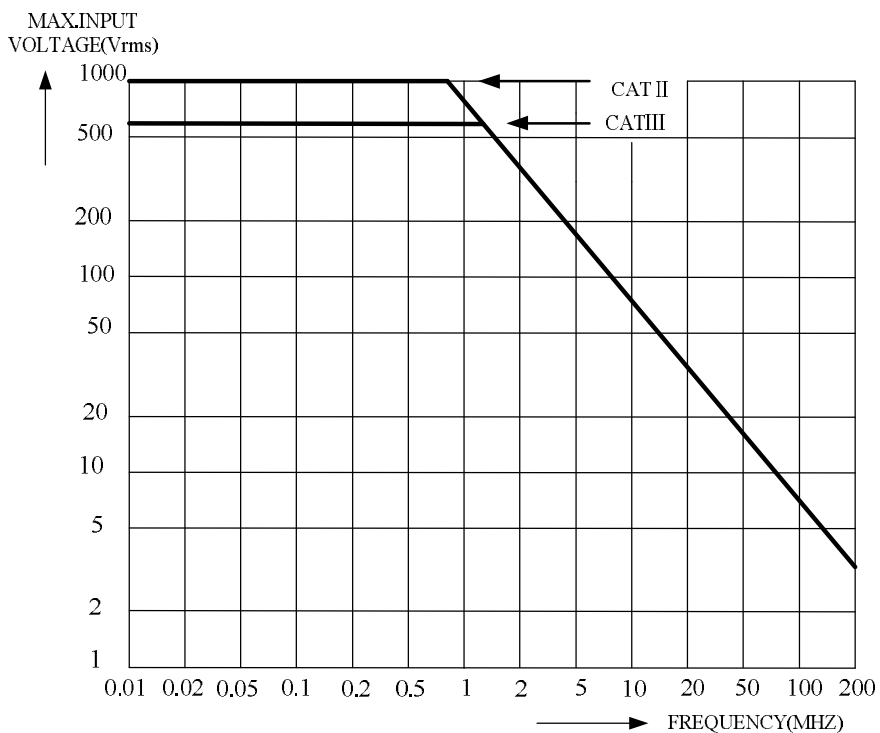

Maximal Voltage From Probe Tip to G round and From Probe Tip to Probe Reference

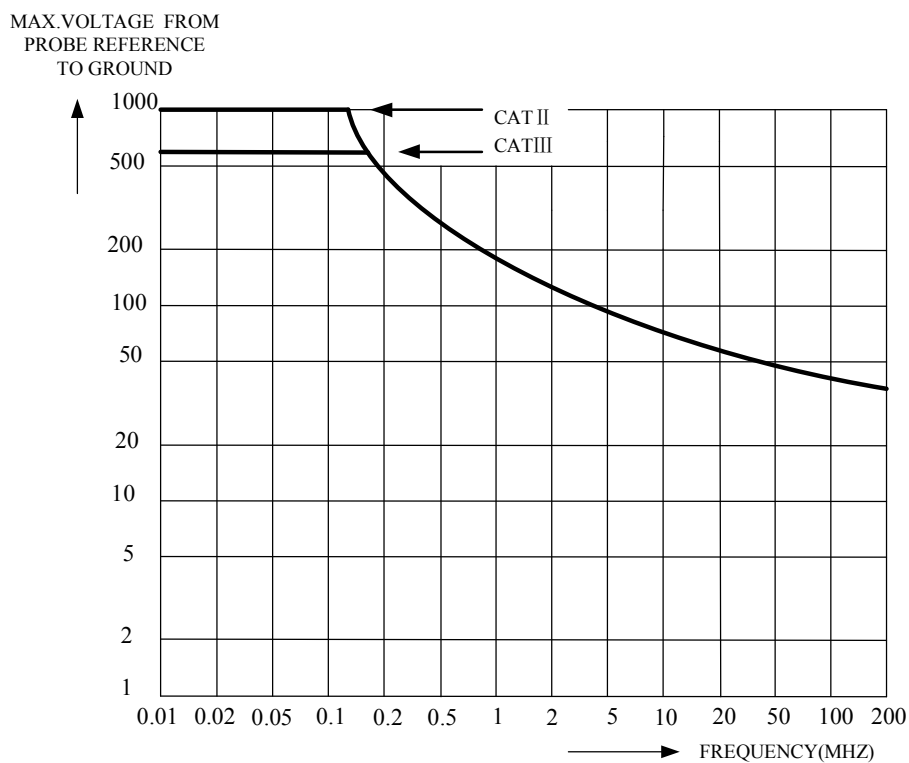

Safe Handling: Maximal Voltage From Probe Reference to Ground

Appendix A: Default Setup

Menu or system	Options, Knobs or Buttons	Default setup
CH1, CH2	Coupling	DC
	BW Limit	Off
	Volts/div	Coarse
	Probe	1X
	Invert	Off
	Filter	Off
	Volts/div	1.00V
MATH	Operation	CH1+CH2
	CH1 Invert	Off
	CH2 Invert	Off
	FFT Operation:	
	Source	CH1
	Window	Hanning
	FFT Zoom	1X
	Scale	dBVrms
	Display	Split
HORIZONTAL	Window	Main Time Base
	Position	0.00 μ s
	Sec/div	500 μ s
	Window Zone	50.0 μ s
	Trigger knob	Level
CURSOR	Type	Off
	Source	CH1
	Horizontal (voltage)	+/-3.2divs
	Vertical (time)	+/-5divs
ACQUIRE	Three Mode Options	Sampling
	Averages	16
	Sampling Method	Real Time
DISPLAY	Type	Vectors
	Persist	off
	Gird	
	Intensity	60%
	Brightness	40%
	Format	YT
	Menu Display	Infinite
SAVE/RECALL	Type	Setups
	Save To	Device

	Setup	No.1
REF	Source	CH1
	REFA	Off
	REFB	Off
UTILITY	Sound	On
	Frequency Counter	On
	USB Device	Computer
	Record	Off
TRIGGER (Edge)	Type	Edge
	Source	CH1
	Slope	Rising
	Mode	Auto
	Coupling	DC
	Level	0.00V
TRIGGER (Pulse)	Type	Pulse
	Source	CH1
	Condition	=
	Set Pulse Width	1.00ms
	Mode	Auto
	Coupling	DC
TRIGGER (Video)	Type	Video
	Source	CH1
	Polarity	Normal
	Sync	All Lines
	Standard	NTSC
	Mode	Auto
TRIGGER (Slope)	Type	Slope
	Source	CH1
	Condition	
	Time	1.00ms
	Mode	Auto
TRIGGER (Alternative)	Type	Alternative
	Source	CH1
	Mode	Edge
	Coupling	DC
	Slope	Rise

Appendix B: Battery Installation

The battery of the SHS800 is separated from its host, please install the battery according to following steps:

1. Dismantle the two screws of the battery cap by using screw knife, as figure 1 shows..
2. Draw back the packing block of the Handheld Digital Oscilloscope, and then dismantle the battery cap, as figure 2 shows.
3. Put battery into the battery bin stably, as figure 3 shows.
4. Cover the battery cap, and tightly twist the two screws which are dismantled from the battery cap forward, such as figure 3 shows.
5. Successful installation of the battery depends on whether the Handheld Digital Oscilloscope could be normally turned on or not.

Notes:

The battery plug is designed to prevent from connecting reversely, it prefers operating slightly to powerfully.

Make a caution at the direction of the battery cap, logo of the battery is attached to the external end.

If The Handheld Digital Oscilloscope can not be turned on normally after correctly installation, it is likely that the battery quantity of electricity has been used off, please refresh for the battery right away.

In the case of not working, battery must be charged once every three months.

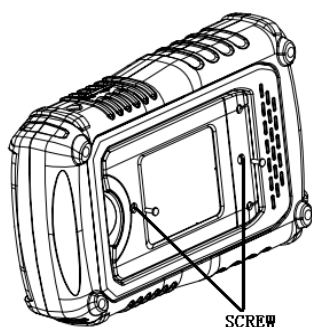

Figure 1

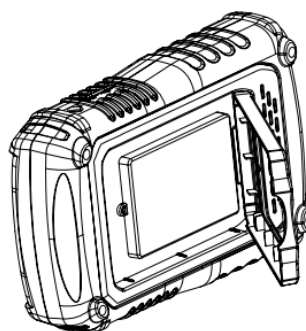

Figure 2

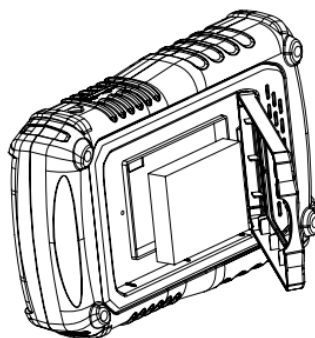

Figure 3

Appendix C: Daily Maintaining and Cleaning

Daily Maintaining

Do not let the LCD exposed in the sun directly for a long period when storing or placing the SHS1000.

CAUTION: To avoid damage to the instrument or probes, do not expose them to sprays, liquids, or solvents

Cleaning

If this instrument requires cleaning, disconnect it from all power sources and clean it with a mild detergent and water. Make sure the instrument is completely dry before reconnecting it to a power source.

To clean the exterior surface, perform the following steps:

1. Remove loose dust on the outside of the instrument and probes with a lint-free cloth. Use care to avoid scratching the clear plastic display filter.
2. Use a soft cloth dampened with water to clean the instrument. Use an aqueous solution of 75% isopropyl alcohol for more efficient cleaning.

Note:

To avoid damage to the surface of the instrument or probes, do not use any abrasive or chemical cleaning agents